Pennsylvania Stormwater Best Management Practices Manual

Chapter 6

Structural BMPs



Chapter 6 Structural BMPs

6.1	Introduction.....	1
6.2	Groupings of Structural BMPs.....	1
6.3	Manufactured Products.....	2
6.4	Volume/Peak Rate Reduction by Infiltration BMPs.....	5
	BMP 6.4.1 Pervious Pavement with Infiltration Bed.....	7
	BMP 6.4.2 Infiltration Basin.....	27
	BMP 6.4.3 Subsurface Infiltration Bed.....	33
	BMP 6.4.4 Infiltration Trench.....	41
	BMP 6.4.5 Rain Garden / Bioretention.....	49
	BMP 6.4.6 Dry Well / Seepage Pit.....	61
	BMP 6.4.7 Constructed Filter.....	71
	BMP 6.4.8 Vegetated Swale.....	83
	BMP 6.4.9 Vegetated Filter Strip.....	99
	BMP 6.4.10 Infiltration Berm & Retentive Grading.....	113
6.5	Volume/Peak Rate Reduction BMPs.....	123
	BMP 6.5.1 Vegetated Roof.....	125
	BMP 6.5.2 Runoff Capture & Reuse.....	139
6.6	Runoff Quality/Peak Rate BMPs.....	149
	BMP 6.6.1 Constructed Wetland.....	151
	BMP 6.6.2 Wet Pond/ Retention Basin.....	163
	BMP 6.6.3 Dry Extended Detention Basin.....	173
	BMP 6.6.4 Water Quality Filters & Hydrodynamic Devices.....	183
6.7	Restoration BMPs.....	189
	BMP 6.7.1 Riparian Buffer Restoration.....	191
	BMP 6.7.2 Landscape Restoration.....	211
	BMP 6.7.3 Soils Amendment & Restoration.....	221
	BMP 6.7.4 Floodplain Restoration.....	231
6.8	Other BMPs and Related Structural Measures.....	241
	BMP 6.8.1 Level Spreader.....	243
	BMP 6.8.2 Special Detention Areas – Parking Lot, Rooftop.....	253

6.1 Introduction

Twenty-one Structural BMPs are listed and described in this chapter. As indicated in both Chapters 4 and 5, many of these “structures” are natural system-based and include vegetation and soils mechanisms as part of their functioning. More conventional “bricks and mortar” structures are also included in this chapter.

Several of the BMPs presented in this chapter lead to variations on a central theme. The vegetated swale is a good example of a core BMP that fosters numerous others. These variations have been included in this chapter with some explanation and reference made as to how and when such variations can be successfully applied. As lengthy as the list of Structural BMPs might be, many more BMPs are expected to emerge as stormwater management practices continue to evolve and mature. Each BMP is outlined using approximately the same structure or outline as has been applied to the Non-Structural BMPs.

6.2 Groupings of Structural BMPs

Structural BMPs are grouped according to the primary, though not exclusive, stormwater functions, as follows:

- Volume/Peak Rate Reduction by Infiltration BMPs**
- Volume/Peak Rate Reduction BMPs**
- Runoff Quality/Peak Rate BMPs**
- Restoration BMPs**
- Other BMPs**

In all cases, these stormwater functions are linked to the Recommended Site Control Guidelines presented in Chapter 3. Most of the Structural BMPs fall into the category of Volume/Peak Rate Reduction. Some of these BMPs also possess excellent water quality protection capabilities as well. Volume and Peak Rate functions also can be provided by a smaller group of increasingly important Structural BMPs such as Vegetated Roofs and Roof Capture/Reuse (e.g., rain barrels and cisterns). Certain BMPs provide water quality and peak rate control functions, without any significant control of volume. The Restoration BMPs and Other BMP categories provide a mix of stormwater functions. Although these BMPs have not been frequently used in the past, they can offer real potential for many Pennsylvania municipalities in the future.

Lastly, two special lists of instructions, or Protocols, have been developed specifically for use with all infiltration-oriented structural BMPs and are presented in Appendix C.

- Protocol 1: Site Evaluation and Soil Infiltration Testing**
- Protocol 2: Infiltration Systems Design and Construction Guidelines**

These Protocols should be followed whenever infiltration-oriented BMPs are being developed. The Protocols set forth a variety of actions common to all infiltration BMPs. These actions should be taken to ensure that proper site conditions and constraints are being addressed, proper design considerations are being taken, and proper construction specifications are being integrated into the overall design of the BMP. An especially important aspect of these instructions focuses on full and careful testing of the soil, thereby necessitating a separate Protocol that addresses soil testing and analysis. If these Protocols are followed, the risk of failed infiltration BMPs will be minimized, if not eliminated.

One of the most challenging technical issues considered in this manual involves the selection of BMPs with a high degree of pollutant reduction or removal efficiency. The Non-Structural BMPs described in Chapter 5 and the Structural BMPs presented in Chapter 6 are all rated in terms of their pollutant removal performance or effectiveness. The initial BMP selection process analyzes the final site plan and estimates the potential pollutant load, using Appendix A. The targeted reduction percentage for representative pollutants (such as 85% reduction in TSS and TP load and 50% reduction in the solute load) is achieved by a suitable combination of Non-Structural and Structural BMPs. This process is described in more detail in Chapter 8.

6.3 Manufactured Products

A variety of product suppliers, distributors, and manufacturers have provided extensive product information to PADEP during the preparation of this manual. Many of these products can be used in conjunction with the Non-Structural BMPs set forth in Chapter 5 as well as the Structural BMPs presented in this chapter. The proper application and use of many of these manufactured products can further the stormwater management goals and objectives of this manual. It should be noted that Pennsylvania does not have an established product review and testing function. The interested reader/user is directed to the following sources to learn about the performance of a specific product or technology:

The Technology Acceptance Reciprocity Partnership (TARP) – A partnership of the states of California, Illinois, Maryland, Massachusetts, New Jersey, New York, Pennsylvania and Virginia that establishes standardized methods to guide the collection and evaluation of new and innovative technology performance across the states. Information is available at: www.dep.state.pa.us/dep/deputate/pollprev/techservices/tarp/index.htm

Environmental Technology Evaluation Center (EvTEC) of The Civil Engineering Research Foundation (CERF), including their Stormwater Best Management Practices (BMPs) Verification Program - information available at <http://www.cerf.org/evtec/index.htm> & http://www.cerf.org/evtec/eval/wsdot_qr.htm

U.S. EPA's Environmental Technology Verification Program (ETV) - information available at <http://www.epa.gov/etv/>

The University of New Hampshire's Center for Stormwater Technology Evaluation and Verification (CSTEV) - information available at <http://www.unh.edu/erg/cstev/index.htm#>

The Chesapeake Bay Program's Innovative Technology Task Force (ITTF) - information about the program as well as many useful links to other programs available at http://www.chesapeakebay.net/info/innov_tech.cfm

New Jersey's Energy and Environmental Technology Verification Program - results available through the New Jersey Corporation for Advanced Technology (NJCAT) at <http://www.njcat.org/>

Disclaimer: The technology descriptions contained in this document including, but not limited to, information on technology applications, performance, limitations, benefits, and cost, have been provided by vendors. No attempt was made to examine, screen or verify company or technology information. The Pennsylvania Department of Environmental Protection has not confirmed the

accuracy or legal adequacy of any disclosures, product performance, or other information provided by the companies appearing here. The inclusion of specific products in this document does not constitute or imply their endorsement or recommendation by the Pennsylvania Department of Environmental Protection.

6.4 Volume/Peak Rate Reduction by Infiltration BMPs

BMP 6.4.1: Pervious Pavement with Infiltration Bed

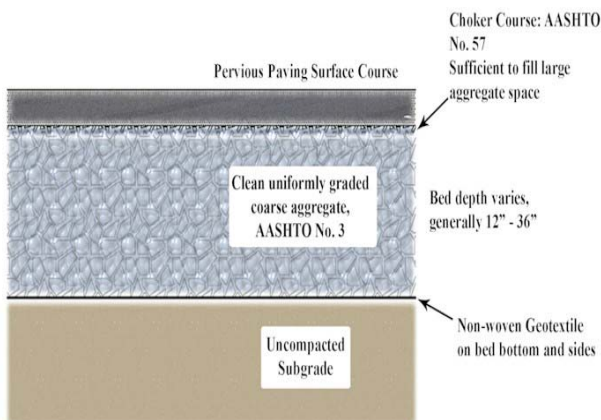

Pervious pavement consists of a permeable surface course underlain by a uniformly-graded stone bed which provides temporary storage for peak rate control and promotes infiltration. The surface course may consist of porous asphalt, porous concrete, or various porous structural pavers laid on uncompacted soil.

<p style="text-align: center;"><u>Key Design Elements</u></p> <ul style="list-style-type: none"> ▪ Almost entirely for peak rate control ▪ Water quality and quantity are not addressed ▪ Short duration storage; rapid restoration of primary uses ▪ Minimize safety risks, potential property damage, and user inconvenience ▪ Emergency overflows ▪ Maximum ponding depths ▪ Flow control structures ▪ Adequate surface slope to outlet 	<p style="text-align: center;"><u>Potential Applications</u></p> <p>Residential: Limited Commercial: Yes Ultra Urban: Yes Industrial: Yes Retrofit: Yes Highway/Road: Limited</p> <hr/> <p style="text-align: center;"><u>Stormwater Functions</u></p> <p>Volume Reduction: Medium Recharge: Medium Peak Rate Control: Medium Water Quality: Medium</p> <hr/> <p style="text-align: center;"><u>Water Quality Functions</u></p> <p>TSS: 85% TP: 85% NO3: 30%</p>
---	---

Other Considerations

- **Protocol 1. Site Evaluation and Soil Infiltration Testing** and **Protocol 2. Infiltration Systems Guidelines** should be followed, see Appendix C

Description

A pervious pavement bed consists of a pervious surface course underlain by a stone bed of uniformly graded and clean-washed coarse aggregate, 1-1/2 to 2-1/2 inches in size, with a void space of at least 40%. The pervious pavement may consist of pervious asphalt, pervious concrete, or pervious pavement units. Stormwater drains through the surface, is temporarily held in the voids of the stone bed, and then slowly drains into the underlying, uncompacted soil mantle. The stone bed can be designed with an overflow control structure so that during large storm events peak rates are controlled, and at no time does the water level rise to the pavement level. A layer of geotextile filter fabric separates the aggregate from the underlying soil, preventing the migration of fines into the bed. The bed bottoms should be level and uncompacted. If new fill is required, it should consist of additional stone and not compacted soil.

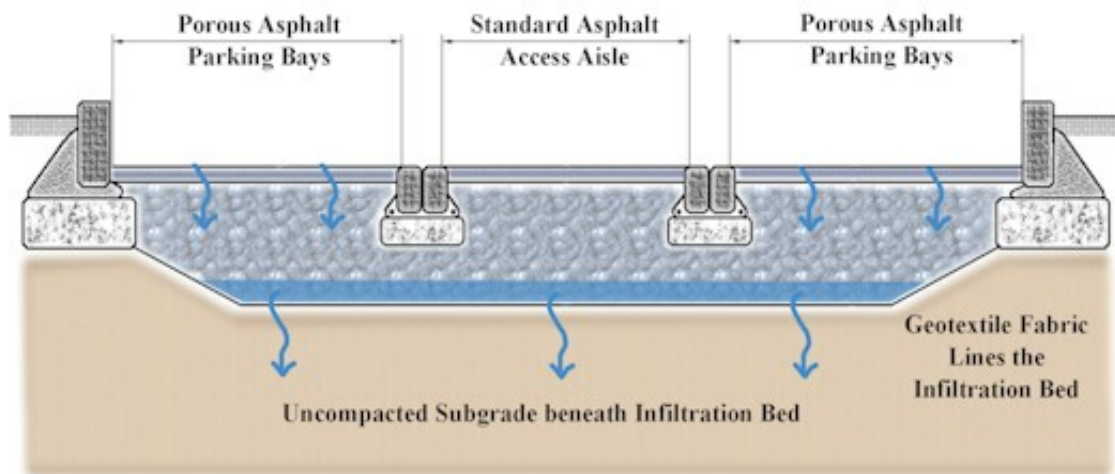

Pervious pavement is well suited for parking lots, walking paths, sidewalks, playgrounds, plazas, tennis courts, and other similar uses. Pervious pavement can be used in driveways if the homeowner is aware of the stormwater functions of the pavement. Pervious pavement roadways have seen wider application in Europe and Japan than in the U.S., although at least one U.S. system has been constructed. In Japan and the U.S., the application of an open-graded asphalt pavement of 1" or less on roadways has been used to provide lateral surface drainage and prevent hydroplaning, but these are applied over impervious pavement on compacted sub-grade. This application is not pervious pavement.

Properly installed and maintained pervious pavement has a significant life-span, and existing systems that are more than twenty years in age continue to function. Because water drains through the surface

course and into the subsurface bed, freeze-thaw cycles do not tend to adversely affect pervious pavement.

Pervious pavement is most susceptible to failure difficulties during construction, and therefore it is important that the construction be undertaken in such a way as to **prevent**:

- Compaction of underlying soil
- Contamination of stone subbase with sediment and fines
- Tracking of sediment onto pavement
- Drainage of sediment laden waters onto pervious surface or into constructed bed

Staging, construction practices, and erosion and sediment control must all be taken into consideration when using pervious pavements.

Studies have shown that pervious systems have been very effective in reducing contaminants such as total suspended solids, metals, and oil and grease. When designed, constructed, and maintained according to the following guidelines, pervious pavement with underlying infiltration systems can dramatically reduce both the rate and volume of runoff, recharge the groundwater, and improve water quality.

In northern climates, pervious pavements have less of a tendency to form black ice and often require less plowing. Winter maintenance is described on page 17. Pervious asphalt and concrete surfaces provide better traction for walking paths in rain or snow conditions.



Variations

Pervious Bituminous Asphalt

Early work on pervious asphalt pavement was conducted in the early 1970’s by the Franklin Institute in Philadelphia and consists of standard bituminous asphalt in which the fines have been screened and reduced, allowing water to pass through small voids. Pervious asphalt is placed directly on the stone subbase in a single 3 ½ inch lift that is lightly rolled to a finish depth of 2 ½ inches.

Because pervious asphalt is standard asphalt with reduced fines, it is similar in appearance to standard asphalt. Recent research in open-graded mixes for highway application has led to additional improvements in pervious asphalt through the use of additives and higher-grade binders. Pervious asphalt is suitable for use in any climate where standard asphalt is appropriate.



Pervious Concrete

Pervious Portland Cement Concrete, or pervious concrete, was developed by the Florida Concrete Association and has seen the most widespread application in Florida and southern areas. Like pervious asphalt, pervious concrete is produced by substantially reducing the number of fines in the mix in order to establish voids for drainage. In northern and mid-Atlantic climates such as Pennsylvania, pervious concrete should always be underlain by a stone subbase designed for stormwater management and should never be placed directly onto a soil subbase.

While pervious asphalt is very similar in appearance to standard asphalt, pervious concrete has a coarser appearance than its conventional counterpart. Care must be taken during placement to avoid working the surface and creating an impervious layer. Pervious concrete has been proven to be an effective stormwater management BMP. Additional information pertaining to pervious concrete, including specifications, is available from the Florida Concrete Association and the National Ready Mix Association.



Pervious Paver Blocks

Pervious Paver Blocks consist of interlocking units (often concrete) that provide some portion of surface area that may be filled with a pervious material such as gravel. These units are often very attractive and are especially well suited to plazas, patios, small parking areas, etc. A number of manufactured products are available, including (but not limited to):



- Turfstone; UNI Eco-stone; Checkerblock; EcoPaver

As products are always being developed, the designer is encouraged to evaluate the benefits of various products with respect to the specific application. Many paver products recommend compaction of the soil and do not include a drainage/storage area, and therefore, they do not provide optimal stormwater management benefits. A system with a compacted subgrade will not provide significant infiltration.

Reinforced Turf and Gravel Filled Grids

Reinforced Turf consists of interlocking structural units that contain voids or areas for turf grass growth and are suitable for traffic loads and parking. Reinforced turf units may consist of concrete or plastic and are underlain by a stone and/or sand drainage system for stormwater management. There are also products available that provide a fully permeable surface through the use of plastic rings/grids filled with gravel.

Reinforced Turf applications are excellent for Fire Access Roads, overflow parking, occasional use parking (such as at religious facilities and athletic facilities). Reinforced turf is also an excellent application to reduce the required standard pavement width of paths and driveways that must occasionally provide for emergency vehicle access.

While both plastic and concrete units perform well for stormwater management and traffic needs, plastic units tend to provide better turf establishment and longevity, largely because the plastic will not absorb water and diminish soil moisture conditions. A number of products (e.g. Grasspave, Geoblock, GravelPave, Grassy Pave, Geoweb) are available and the designer is encouraged to evaluate and select a product suitable to the design in question.



Applications

Parking

Walkways

Pervious Pavement Walkways

Pervious pavement has also been used in walkways and sidewalks. These installations typically consist of a shallow (8 in. minimum) aggregate trench that is sloped to follow the surface slope of the path. In the case of relatively mild surface slopes, the aggregate infiltration trench may be “terraced” into level reaches in order to maximize the infiltration capacity, at the expense of additional aggregate.



Playgrounds



Alleys

Roof drainage; Direct connection of roof leaders and/or inlets

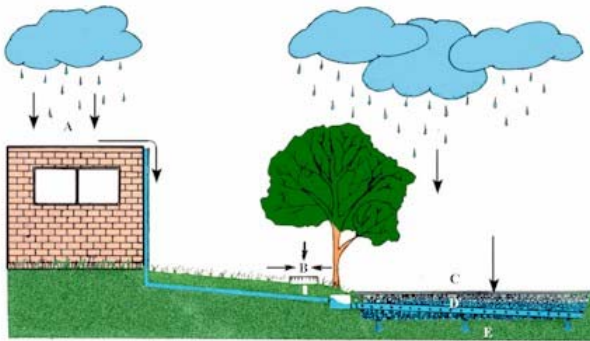

Limited use for roads and highways



Design Considerations

1. Protocol 1, Site Evaluation and Soil Infiltration Testing required (see Appendix C).
2. Protocol 2, Infiltration Systems Guidelines must be met (see Appendix C).
3. The overall site should be evaluated for potential pervious pavement / infiltration areas early in the design process, as effective pervious pavement design requires consideration of grading.
4. Orientation of the parking bays along the existing contours will significantly reduce the need for cut and fill.
5. Pervious pavement and infiltration beds **should not be placed on areas of recent fill** or compacted fill. Any grade adjust requiring fill should be done using the stone subbase material. Areas of historical fill (>5 years) may be considered for pervious pavement.

6. The bed bottom should not be compacted, however the stone subbase should be placed in lifts and lightly rolled according to the specifications.
7. During construction, the excavated bed may serve as a temporary sediment basin or trap. This will reduce overall site disturbance. The bed should be excavated to within twelve (12) inches of the final bed bottom elevation for use as a sediment trap or basin. Following construction and site stabilization, sediment should be removed and final grades established.
8. **Bed bottoms should be level or nearly level.** Sloping bed bottoms will lead to areas of ponding and reduced distribution.
9. **All systems should be designed with an overflow system.** Water within the subsurface stone bed should never rise to the level of the pavement surface. Inlet boxes can be used for cost-effective overflow structures. All beds should empty to meet the criteria in Chapter 3.
10. While infiltration beds are typically sized to handle the increased volume from a storm, they should also be able to convey and mitigate the peak of the less-frequent, more intense storms (such as the 100-yr). Control in the beds is usually provided in the form of an outlet control structure. A modified inlet box with an internal weir and low-flow orifice is a common type of control structure. The specific design of these structures may vary, depending on factors such as rate and storage requirements, but it always should include positive overflow from the system.
11. The subsurface bed and overflow may be designed and evaluated in the same manner as a detention basin to demonstrate the mitigation of peak flow rates. In this manner, the need for a detention basin may be eliminated or reduced in size.

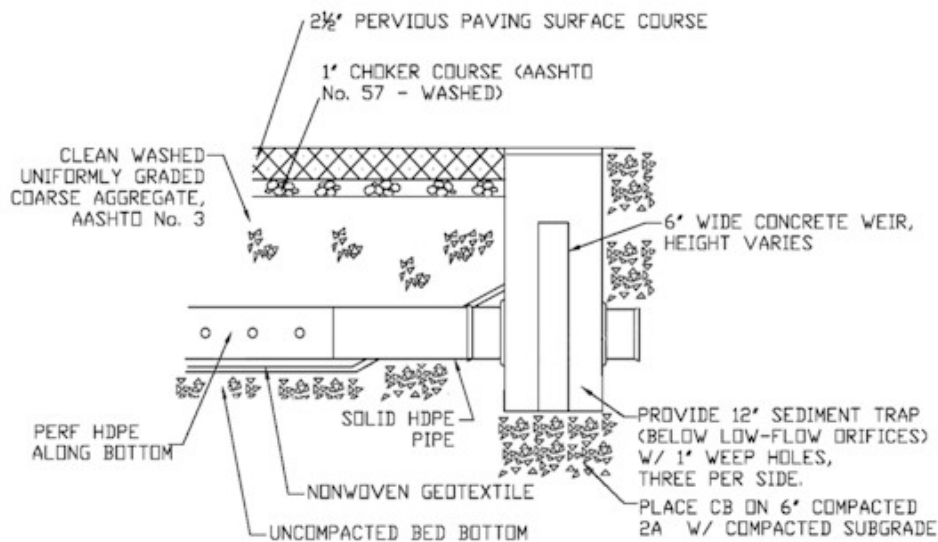

12. A weir plate or weir within an inlet or overflow control structure may be used to maximize the water level in the stone bed while providing sufficient cover for overflow pipes.

- 13. Perforated pipes along the bottom of the bed may be used to evenly distribute runoff over the entire bed bottom. Continuously perforated pipes should connect structures (such as cleanouts and inlet boxes). Pipes should lay flat along the bed bottom and provide for uniform distribution of water. Depending on size, these pipes may provide additional storage volume.
- 14. Roof leaders and area inlets may be connected to convey runoff water to the bed. Water Quality Inserts or Sump Inlets should be used to prevent the conveyance of sediment and debris into the bed.
- 15. Infiltration areas should be located within the immediate project area in order to control runoff at its source. Expected use and traffic demands should also be considered in pervious pavement placement.
- 16. Control of sediment is critical. Rigorous installation and maintenance of erosion and sediment control measures should be provided to prevent sediment deposition on the pavement surface or within the stone bed. Nonwoven geotextile may be folded over the edge of the pavement until the site is stabilized. The Designer should consider the placement of pervious pavement to reduce the likelihood of sediment deposition. Surface sediment should be removed by a vacuum sweeper and should not be power-washed into the bed.

- 17. Infiltration beds may be placed on a slope by benching or terracing parking bays. Orienting parking bays along existing contours will reduce site disturbance and cut/fill requirements.



- 18. The underlying infiltration bed is typically 12-36 inches deep and comprised of clean, uniformly graded aggregate with approximately 40% void space. AASHTO No.3, which ranges 1.5-2.5 inches in gradation, is often used. Depending on local aggregate availability, both larger and smaller size aggregate has been used. The critical requirements are that the aggregate be uniformly graded, clean washed, and contain a significant void content. The depth of the bed is a function of stormwater storage requirements, frost depth considerations, site grading, and anticipated loading. Infiltration beds are typically sized to mitigate the increased runoff volume from a 2-yr design storm.

- 19. Most pervious pavement installations are underlain by an aggregate bed; alternative subsurface storage products may also be employed. These include a variety of proprietary, interlocking plastic units that contain much greater storage capacity than aggregate, at an increased cost.

- 20. All pervious pavement installations should have a backup method for water to enter the stone storage bed in the event that the pavement fails or is altered. In uncurbed lots, this backup drainage may consist of an unpaved 2 ft wide stone edge drain connected directly to the bed. In curbed lots, inlets with water quality devices may be required at low spots. Backup drainage elements will ensure the functionality of the infiltration system, if the pervious pavement is compromised.



21. In areas with poorly draining soils, infiltration beds below pervious pavement may be designed to slowly discharge to adjacent wetlands or bioretention areas. Only in extreme cases (i.e. industrial sites with contaminated soils) will the aggregate bed need to be lined to prevent infiltration.
22. In those areas where the threat of spills and groundwater contamination is likely, pretreatment systems, such as filters and wetlands, may be required before any infiltration occurs. In hot spot areas, such as truck stops, and fueling stations, the appropriateness of pervious pavement must be carefully considered. A stone infiltration bed located beneath standard pavement, preceded by spill control and water quality treatment, may be more appropriate.
23. The use of pervious pavement must be carefully considered in areas where the pavement may be seal coated or paved over due to lack of awareness, such as individual home driveways. In those situations, a system that is not easily altered by the property owner may be more appropriate. An example would include an infiltration system constructed under a conventional driveway. Educational signage at pervious pavement installations may guarantee its prolonged use in some areas.

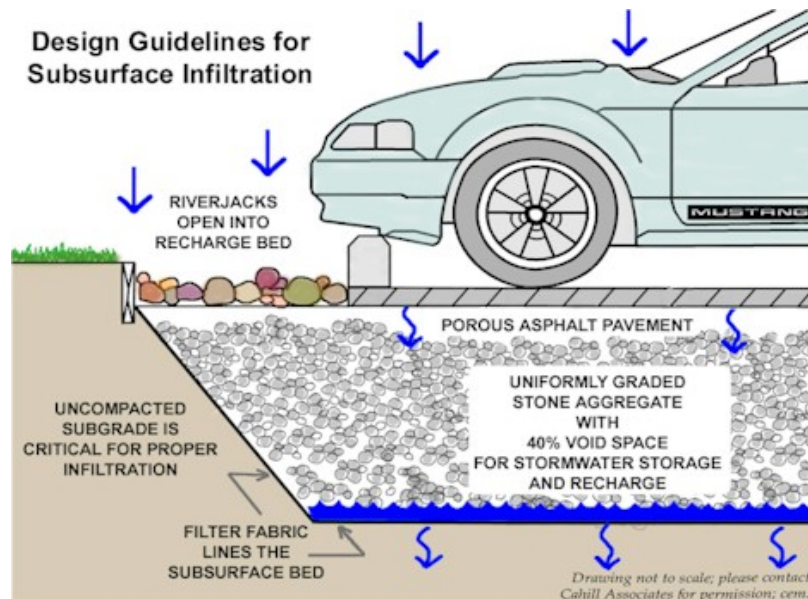

Detailed Stormwater Functions

Volume Reduction Calculations

$$\text{Volume} = \text{Depth}^* (\text{ft}) \times \text{Area} (\text{sf}) \times \text{Void Space}$$

*Depth is the depth of the water stored during a storm event, depending on the drainage area and conveyance to the bed.

$$\text{Infiltration Volume} = \text{Bed Bottom Area} (\text{sf}) \times \text{Infiltration design rate} (\text{in/hr}) \times \text{Infiltration period}^* (\text{hr}) \times (1/12)$$

*Infiltration Period is the time when bed is receiving runoff and capable of infiltrating at the design rate. Not to exceed 72 hours.

Peak Rate Mitigation

See in Chapter 8 for Peak Rate Mitigation methodology that addresses link between volume reduction and peak rate control.

Water Quality Improvement

See in Chapter 8 for Water Quality methodology that addresses pollutant removal effectiveness of this BMP.

Construction Sequence

1. Due to the nature of construction sites, pervious pavement and other infiltration measures should be installed toward the end of the construction period, if possible. Infiltration beds under pervious pavement may be used as temporary sediment basins or traps provided that they are not excavated to within 12 inches of the designated bed bottom elevation. Once the site is stabilized and sediment storage is no longer required, the bed is excavated to its final grade and the pervious pavement system is installed.
2. The existing subgrade under the bed areas should NOT be compacted or subject to excessive construction equipment traffic prior to geotextile and stone bed placement.
3. Where erosion of subgrade has caused accumulation of fine materials and/or surface ponding, this material shall be removed with light equipment and the underlying soils scarified to a minimum depth of 6 inches with a York rake (or equivalent) and light tractor. All fine grading shall be done by hand. All bed bottoms should be at a level grade.
4. Earthen berms (if used) between infiltration beds should be left in place during excavation. These berms do not require compaction if proven stable during construction.
5. Geotextile and bed aggregate should be placed immediately after approval of subgrade preparation. Geotextile should be placed in accordance with manufacturer’s standards and recommendations. Adjacent strips of geotextile should overlap a minimum of 16 in. It should also be secured at least 4 ft. outside of bed in order to prevent any runoff or sediment from entering the storage bed. This edge strip should remain in place until all bare soils contiguous to beds are stabilized and vegetated. As the site is fully stabilized, excess geotextile along bed edges can be cut back to bed edge.
6. Clean (washed) uniformly graded aggregate is placed in the bed in 8-inch lifts. Each layer should be lightly compacted, with the construction equipment kept off the bed bottom as much as possible. Once bed aggregate is installed to the desired grade, a +/- 1 in. layer of choker base course (AASHTO #57) aggregate should be installed uniformly over the surface in order to provide an even surface for paving.





7. The pervious pavement should be installed in accordance with current standards. Further information can be obtained from the appropriate Association.

The full permeability of the pavement surface should be tested by application of clean water at the rate of at least 5 gpm over the surface, using a hose or other distribution device. All applied water should infiltrate directly without puddle formation or surface runoff.

Maintenance Issues

The primary goal of pervious pavement maintenance is to prevent the pavement surface and/or underlying infiltration bed from being clogged with fine sediments. To keep the system clean throughout the year and prolong its life span, the pavement surface should be vacuumed biannually with a commercial cleaning unit. **Pavement washing systems or compressed air units are not recommended.** All inlet structures within or draining to the infiltration beds should also be cleaned out biannually.

Planted areas adjacent to pervious pavement should be well maintained to prevent soil washout onto the pavement. If any washout does occur it should be cleaned off the pavement immediately to prevent further clogging of the pores. Furthermore, if any bare spots or eroded areas are observed within the planted areas, they should be replanted and/or stabilized at once. Planted areas should be inspected on a semiannual basis. All trash and other litter that is observed during these inspections should be removed.

Superficial dirt does not necessarily clog the pavement voids. However, dirt that is ground in repeatedly by tires can lead to clogging. Therefore, trucks or other heavy vehicles should be prevented from tracking or spilling dirt onto the pavement. Furthermore, all construction or hazardous materials carriers should be prohibited from entering a pervious pavement lot.

Special Maintenance Considerations:

- Prevent Clogging of Pavement Surface with Sediment
 - Vacuum pavement 2 or 3 times per year
 - Maintain planted areas adjacent to pavement
 - Immediately clean any soil deposited on pavement
 - Do not allow construction staging, soil/mulch storage, etc. on unprotected pavement surface
 - Clean inlets draining to the subsurface bed twice per year

Winter Maintenance

Winter maintenance for a pervious parking lot may be necessary but is usually less intensive than that required for a standard impervious surface. By its very nature, a pervious pavement system with subsurface aggregate bed has superior snow melting characteristics than standard pavement. The underlying stone bed tends to absorb and retain heat so that freezing rain and snow melt faster on pervious pavement. Therefore, ice and light snow accumulation are generally not as problematic. However, snow will accumulate during heavier storms. Abrasives such as sand or cinders should not be applied on or adjacent to the pervious pavement. Snow plowing is fine, provided it is done carefully (i.e. by setting the blade slightly higher than usual, about an inch). Salt is acceptable for use as a deicer on the pervious pavement, though nontoxic, organic deicers, applied either as blended, magnesium chloride-based liquid products or as pretreated salt, are preferable.

Repairs

Potholes in the pervious pavement are unlikely; though settling might occur if a soft spot in the subgrade is not removed during construction. For damaged areas of less than 50 square feet, a declivity could be patched by any means suitable with standard pavement, with the loss of porosity of that area being insignificant. The declivity can also be filled with pervious mix. If an

area greater than 50 sq. ft. is in need of repair, approval of patch type should be sought from either the engineer or owner. Under no circumstance should the pavement surface ever be seal coated. Any required repair of drainage structures should be done promptly to ensure continued proper functioning of the system.

Cost Issues

- Pervious asphalt, with additives, is generally 10% to 20% higher (2005) in cost than standard asphalt on a unit area basis.
- Pervious concrete as a material is generally more expensive than asphalt and requires more labor and experience for installation due to specific material constraints.
- Permeable interlocking concrete pavement blocks vary in cost depending on type and manufacturer.

The added cost of a pervious pavement/infiltration system lies in the underlying stone bed, which is generally deeper than a conventional subbase and wrapped in geotextile. However, this additional cost is often offset by the significant reduction in the required number of inlets and pipes. Also, since pervious pavement areas are often incorporated into the natural topography of a site, there generally is less earthwork and/or deep excavations involved. Furthermore, pervious pavement areas with subsurface infiltration beds often eliminate the need (and associated costs, space, etc.) for detention basins. When all of these factors are considered, pervious pavement with infiltration has proven itself less expensive than the impervious pavement with associated stormwater management. Recent (2005) installations have averaged between \$2000 and \$2500 per parking space, for the pavement and stormwater management.

Specifications

The following specifications are provided for informational purposes only. These specifications include information on acceptable materials for typical applications, but are by no means exclusive or limiting. The designer is responsible for developing detailed specifications for individual design projects in accordance with the project conditions.

1. **Stone** for infiltration beds shall be 2-inch to 1-inch uniformly graded coarse aggregate, with a wash loss of no more than 0.5%, AASHTO size number 3 per AASHTO Specifications, Part I, 19th Ed., 1998, or later and shall have voids 40% as measured by ASTM-C29. Choker base course aggregate for beds shall be 3/8 inch to 3/4 inch uniformly graded coarse aggregate AASHTO size number 57 per Table 4, AASHTO Specifications, Part I, 13th Ed., 1998 (p. 47).
2. **Non-Woven Geotextile** shall consist of needled nonwoven polypropylene fibers and meet the following properties:
 - a. Grab Tensile Strength (ASTM-D4632) ≥ 120 lbs
 - b. Mullen Burst Strength (ASTM-D3786) ≥ 225 psi
 - c. Flow Rate (ASTM-D4491) ≥ 95 gal/min/ft²
 - d. UV Resistance after 500 hrs (ASTM-D4355) $\geq 70\%$
 - e. Heat-set or heat-calendared fabrics are not permitted.

Acceptable types include Mirafi 140N, Amoco 4547, Geotex 451, or approved others.

- 3. **Pipe** shall be continuously perforated, smooth interior, with a minimum inside diameter of 6-inches. High-density polyethylene (HDPE) pipe shall meet AASHTO M252, Type S or AASHTO M294, Type S.

4. **Storm Drain Inlets and Structures**

- a. Concrete Construction: Concrete construction shall be in accordance with PennDOT Pub. 4082003 including current supplements or latest edition.
- b. Precast concrete inlets and manholes: Precast concrete inlets may be substituted for cast-in-place structures and shall be constructed as specified for cast-in-place. Standard inlet boxes will be modified to provide minimum 12" sump storage and bottom leaching basins, open to gravel sumps in sub-grade, when situated in the recharge bed.
- c. All PVC Catch Basins/Cleanouts/Inline Drains shall have H-10 or H-20 rated grates, depending on their placement (H-20 if vehicular loading).
- d. Steel reinforcing bars over the top of the outlet structure shall conform to ASTM A615, grades 60 and 40.
- e. Permanent turf reinforcement matting shall be installed according to manufacturers' specifications.

5. **Pervious Bituminous Asphalt**

Bituminous surface course for **pervious paving** should be two and one-half (2.5) inches thick with a bituminous mix of 5.75% to 6% by weight dry aggregate. **In accordance with ASTM D6390, drain down of the binder shall be no greater than 0.3%.** If more absorptive aggregates, such as limestone, are used in the mix, then the amount of bitumen is to be based on the testing procedures outlined in the National Asphalt Pavement Association's Information Series 131 – "Pervious Asphalt Pavements" (2003) or PennDOT equivalent.

Use neat asphalt binder modified with an elastomeric polymer to produce a binder meeting the requirements of PG 76-22 as specified in AASHTO MP-1. The elastomer polymer shall be styrene-butadiene-styrene (SBS), or approved equal, applied at a rate of 3% by weight of the total binder. The composite materials shall be thoroughly blended at the asphalt refinery or terminal prior to being loaded into the transport vehicle. The polymer modified asphalt binder shall be heat and storage stable.

Aggregate shall be minimum 90% crushed material and have a gradation of:

U.S. Standard Sieve Size	Percent Passing
½ (12.5 mm)	100
3/8 (9.5 mm)	92-98
4 (4.75 mm)	34-40
8 (2.36 mm)	14-20
16 (1.18 mm)	7-13
30 (0.60 mm)	0-4
200 (0.075mm)	0-2

Add hydrated lime at a dosage rate of 1.0% by weight of the total dry aggregate to mixes containing granite. Hydrated lime shall meet the requirements of ASTM C 977. The additive must be able to prevent the separation of the asphalt binder from the aggregate and achieve a

required tensile strength ratio (TSR) of at least 80% on the asphalt mix when tested in accordance with AASHTO T 283. The asphaltic mix shall be tested for its resistance to stripping by water in accordance with ASTM D-1664. If the estimated coating area is not above 95 percent, anti-stripping agents shall be added to the asphalt.

Pervious pavement shall not be installed on wet surfaces or when the ambient air temperature is 50 degrees Fahrenheit or lower. The temperature of the bituminous mix shall be between 300 degrees Fahrenheit and 350 degrees Fahrenheit (based on the recommendations of the asphalt supplier).

6. Pervious Concrete
GENERAL

Weather Limitations: Do not place Portland cement pervious pavement mixtures when the ambient temperature is 40 degrees Fahrenheit or lower or 90 degrees Fahrenheit or higher, unless otherwise permitted in writing by the Engineer.

Test Panels: Regardless of qualification, Contractor is to place, joint and cure at least two test panels, each to be a minimum of 225 sq. ft. at the required project thickness to demonstrate to the Engineer’s satisfaction that in-place unit weights can be achieved and a satisfactory pavement can be installed at the site location.

Test panels may be placed at any of the specified Portland Cement pervious locations. Test panels shall be tested for thickness in accordance with ASTM C 42; void structure in accordance with ASTM C 138; and for core unit weight in accordance with ASTM C 140, paragraph 6.3.

Satisfactory performance of the test panels will be determined by:
Compacted thickness no less than ¼” of specified thickness.

Void Structure: 15% minimum; 21% maximum. Unit weight plus or minus 5 pcf of the design unit weight.

If measured void structure falls below 15% or if measured thickness is greater than ¼” less than the specified thickness or if measured weight falls less than 5 pcf below unit weight, the test panel shall be removed at the contractor’s expense and disposed of in an approved landfill.

If the test panel meets the above-mentioned requirements, it can be left in-place and included in the completed work.

CONCRETE MIX DESIGN

Contractor shall furnish a proposed mix design with proportions of materials to the Engineer prior to commencement of work. The data shall include unit weights determined in accordance with ASTM C29 paragraph 11, jiggling procedure.

MATERIALS

Cement: Portland Cement Type I or II conforming to ASTM C 150 or Portland Cement Type IP or IS conforming to ASTM C 595.

Aggregate: Use No 8 coarse aggregate (3/8 to No. 16) per ASTM C 33 or No. 89 coarse aggregate (3/8 to No. 50) per ASTM D 448. If other gradation of aggregate is to be used, submit data on proposed material to owner for approval.

Air Entraining Agent: Shall comply with ASTM C 260 and shall be used to improve resistance to freeze/thaw cycles.

Admixtures: The following admixtures shall be used:

Type D Water Reducing/Retarding – ASTM C 494.

A hydration stabilizer that also meets the requirements of ASTM C 494 Type B Retarding or Type D Water Reducing/Retarding admixtures. This stabilizer suspends cement hydration by forming a protective barrier around the cementitious particles, which delays the particles from achieving initial set.

Water: Potable shall be used.

Proportions:

Cement Content: For pavements subjected to vehicular traffic loading, the total cementitious material shall not be less than 600 lbs. Per cy.

Aggregate Content: the volume of aggregate per cu. yd. shall be equal to 27 cu.ft. when calculated as a function of the unit weight determined in accordance with ASTM C 29 jiggling procedure. Fine aggregate, if used, should not exceed 3 cu. ft. and shall be included in the total aggregate volume.

Admixtures: Shall be used in accordance with the manufacturer's instructions and recommendations.

Mix Water: Mix water shall be such that the cement paste displays a wet metallic sheen without causing the paste to flow from the aggregate. (Mix water yielding a cement paste with a dull-dry appearance has insufficient water for hydration).

- Insufficient water results in inconsistency in the mix and poor bond strength.
- High water content results in the paste sealing the void system primarily at the bottom and poor surface bond.

An aggregate/cement (A/C) ratio range of 4:1 to 4.5:1 and a water/cement (W/C) ratio range of 0.34 to 0.40 should produce pervious pavement of satisfactory properties in regard to permeability, load carrying capacity, and durability characteristics.

INSTALLATION

Portland Cement Pervious Pavement Concrete Mixing, Hauling and Placing:

Mix Time: Truck mixers shall be operated at the speed designated as mixing speed by the manufacturer for 75 to 100 revolutions of the drum.

Transportation: The Portland Cement aggregate mixture may be transported or mixed on site and should be used within one (1) hour of the introduction of mix water, unless otherwise approved by an engineer. This time can be increased to 90 minutes when utilizing the specified hydration stabilizer. Each truck should not haul more than two (2) loads before being cycled to another type concrete. Prior to placing concrete, the subbase shall be moistened and in a wet condition. Failure to provide a moist subbase will result in a reduction in strength of the pavement.

Discharge: Each mixer truck will be inspected for appearance of concrete uniformity according to this specification. Water may be added to obtain the required mix consistency. A minimum of 20 revolutions at the manufacturer's designated mixing speed shall be required following any addition of water to the mix. Discharge shall be a continuous operation and shall be completed as quickly as possible. Concrete shall be deposited as close to its final position as practicable and such that fresh concrete enters the mass of previously placed concrete. The practice of discharging onto subgrade and pulling or shoveling to final placement is not allowed.

Placing and Finishing Equipment: Unless otherwise approved by the Owner or Engineer in writing, the Contractor shall provide mechanical equipment of either slipform or form riding with a following compactive unit that will provide a minimum of 10 psi vertical force. The pervious concrete pavement will be placed to the required cross section and shall not deviate more than +/- 3/8 inch in 10 feet from profile grade. If placing equipment does not provide the minimum specified vertical force, a full width roller or other full width compaction device that provides sufficient compactive effort shall be used immediately following the strike-off operation. After mechanical or other approved strike-off and compaction operation, no other finishing operation will be allowed. If vibration, internal or surface applied, is used, it shall be shut off immediately when forward progress is halted for any reason. The Contractor will be restricted to pavement placement widths of a maximum of fifteen (15') feet unless the Contractor can demonstrate competence to provide pavement placement widths greater than that to the satisfaction of the Engineer.

Curing: Curing procedures shall begin within 20 minutes after the final placement operations. The pavement surface shall be covered with a minimum six-(6) mil thick polyethylene sheet or other approved covering material. Prior to covering, a fog or light mist shall be sprayed above the surface when required due to ambient conditions (high temperature, high wind, and low humidity). The cover shall overlap all exposed edges and shall be secured (without using dirt) to prevent dislocation due to winds or adjacent traffic conditions.

Cure Time:

1. Portland Cement Type I, II, or IS – 7 days minimum.
2. No truck traffic shall be allowed for 10 days (no passenger car/light trucks for 7 days).

Jointing: Control (contraction) joints shall be installed at 20-foot intervals. They shall be installed at a depth of the 1/4 the thickness of the pavement. These joints can be installed in the plastic concrete or saw cut. If saw cut, the procedure should begin as soon as the pavement has hardened sufficiently to prevent raveling and uncontrolled cracking (normally after curing). Transverse construction joints shall be installed whenever placing is suspended a sufficient length of time that concrete may begin to harden. In order to assure aggregate bond at construction joints, a bonding agent suitable for bonding fresh concrete shall be brushed, trolled, or sprayed on the existing pavement surface edge. Isolation (expansion) joints will not be used except when pavement is abutting slabs or other adjoining structures.

TESTING, INSPECTION, AND ACCEPTANCE

Laboratory Testing:

The owner will retain an independent testing laboratory. The testing laboratory shall conform to the applicable requirements of ASTM E 329 "Standard Recommended Practice for Inspection and Testing Agencies for Concrete, Steel, and Bituminous Materials as Used in Construction" and ASTM C 1077 "Standard Practice for Testing Concrete and Concrete Aggregates for use in Construction, and Criteria for Laboratory Evaluation" and shall be inspected and accredited by the Construction Materials Engineering Council, Inc. or by an equivalent recognized national authority.

The Agent of the testing laboratory performing field sampling and testing of concrete shall be certified by the American Concrete Institute as a Concrete Field Testing Technician Grade I, or by a recognized state or national authority for an equivalent level of competence.

Testing and Acceptance:

A minimum of 1 gradation test of the subgrade is required every 5000 square feet to determine percent passing the No. 200 sieve per ASTM C 117.

A minimum of one test for each day's placement of pervious concrete in accordance with ASTM C 172 and ASTM C 29 to verify unit weight shall be conducted. Delivered unit weights are to be determined in accordance with ASTM C 29 using a 0.25 cubic foot cylindrical metal measure.

The measure is to be filled and compacted in accordance with ASTM C 29 paragraph 11, jiggling procedure. The unit weight of the delivered concrete shall be +/- 5 pcf of the design unit weight.

Test panels shall have two cores taken from each panel in accordance with ASTM 42 at a minimum of seven (7) days after placement of the pervious concrete. The cores shall be measured for thickness, void structure, and unit weight. Untrimmed, hardened core samples shall be used to determine placement thickness. The average of all production cores shall not be less than the specified thickness with no individual core being more than ½ inch less than the specified thickness. After thickness determination, the cores shall be trimmed and measured for unit weight in the saturated condition as described in paragraph 6.3.1 of 'Saturation' of ASTM C 140 "Standard Methods of Sampling and Testing Concrete Masonry Units." The trimmed cores shall be immersed in water for 24 hours, allowed to drain for one (1) minute, surface water removed with a damp cloth, then weighed immediately. Range of satisfactory unit weight values are +/- 5 pcf of the design unit weight.

After a minimum of 7 days following each placement, three cores shall be taken in accordance with ASTM C 42. The cores shall be measured for thickness and unit weight determined as described above for test panels. Core holes shall be filled with concrete meeting the pervious mix design.

References and Additional Sources

Adams, Michele (2003). Porous Asphalt Pavement with Recharge Beds: 20 Years & Still Working, *Stormwater 4*, 24-32.

Backstrom, Magnus (1999). *Porous Pavement in a Cold Climate*, Licentiate Thesis, Lulea, Sweden: Lulea University of Technology (<http://epubl.luth.se>).

Cahill, Thomas (1993). *Porous Pavement with Underground Recharge Beds, Engineering Design Manual*, West Chester Pennsylvania: Cahill Associates.

Cahill, Thomas (1994). A Second Look at Porous Pavement/Underground Recharge, *Watershed Protection Techniques*, 1, 76-78.

Cahill, Thomas, Michele Adams, and Courtney Marm (2003). Porous Asphalt: The Right Choice for Porous Pavements, *Hot Mix Asphalt Technology* September-October.

Ferguson, Bruce (2005). *Porous Pavements*, Boca Raton, Florida: CRC Press.

Florida Concrete and Products Association (no date). *Construction of a Portland Cement Pervious Pavement*, Orlando: Florida Concrete and Products Association.

Hossain, Mustaque, Larry A. Scofield, and W.R. Meier, Jr. (1992). Porous Pavement for Control of Highway Runoff in Arizona: Performance to Date, *Transportation Research Record* 1354, 45-54.

Jackson, Newt (2003). *Porous Asphalt Pavements*, Information Series 131, Lanham, Maryland: National Asphalt Pavement Association.

Kandhal, Prithvi S. (2002). *Design, Construction, and Maintenance of Open-Graded Asphalt Friction Courses*, Information Series 115, Lanham, Maryland: National Asphalt Pavement Association.

Kandhal, Prithvi S., and Rajib B. Mallick (1998). *Open-Graded Asphalt Friction Course: State of the Practice*, Report No. 98-7, Auburn, Alabama: Auburn University National Center for Asphalt Technology.

Kandhal, Prithvi S., and Rajib B. Mallick (1999). *Design of New-Generation Open-Graded Friction Courses*, Report No. 99-2, Auburn, Alabama: Auburn University National Center for Asphalt Technology.

Mallick, Rajib B., Prithvi S. Kandhal, L. Allen Cooley Jr., and Donald E. Watson (2000). *Design, Construction and Performance of New-Generation Open-Graded Friction Courses*, Report No. 2000-01, Auburn, Alabama: Auburn University National Center for Asphalt Technology.

Paine, John E. (1990). *Stormwater Design Guide, Portland Cement Pervious Pavement*, Orlando: Florida Concrete and Products Association.

Smith, David R. (2001). *Permeable Interlocking Concrete Pavements: Selection, Design, Construction, Maintenance*, 2nd ed., Washington: Interlocking Concrete Pavement Institute.

Tappeiner, Walter J. (1993). *Open-Graded Asphalt Friction Course*, Information Series 115, Lanham, Maryland: National Asphalt Pavement Association.

Thelen, E. and Howe, L.F. (1978). *Porous Pavement*, Philadelphia: Franklin Institute Press.

BMP 6.4.2: Infiltration Basin

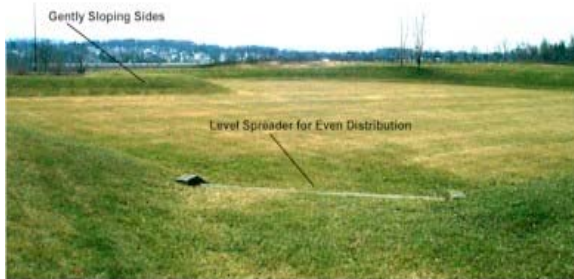

An Infiltration Basin is a shallow impoundment that stores and infiltrates runoff over a level, uncompacted, (preferably undisturbed area) with relatively permeable soils.

<p style="text-align: center;"><u>Key Design Elements</u></p> <ul style="list-style-type: none"> ▪ Maintain a minimum 2-foot separation to bedrock and seasonally high water table, provide distributed infiltration area (5:1 impervious area to infiltration area - maximum), site on natural, uncompacted soils with acceptable infiltration capacity, and follow other guidelines described in Protocol 2: Infiltration Systems Guidelines ▪ Uncompacted sub-grade ▪ Infiltration Guidelines and Soil Testing Protocols apply ▪ Preserve existing vegetation, if possible ▪ Design to hold/infiltrate volume difference in 2-yr storm or 1.5" storm ▪ Provide positive stormwater overflow through engineered outlet structure. ▪ Do not install on recently placed fill (<5 years). ▪ Allow 2 ft buffer between bed bottom and seasonal high groundwater table and 2 ft buffer for rock. ▪ When possible, place on upland soils. ▪ 	<p style="text-align: center;"><u>Potential Applications</u></p> <p style="text-align: center;">Residential: Yes Commercial: Yes Ultra Urban: Limited Industrial: Yes* Retrofit: Yes Highway/Road: Limited</p> <p><small>* Applicable with specific consideration to design.</small></p> <hr/> <p style="text-align: center;"><u>Stormwater Functions</u></p> <p style="text-align: center;">Volume Reduction: High Recharge: High Peak Rate Control: Med./High Water Quality: High</p> <hr/> <p style="text-align: center;"><u>Water Quality Functions</u></p> <p style="text-align: center;">TSS: 85% TP: 85% NO3: 30%</p>
---	---

Other Considerations

- **Protocol 1. Site Evaluation and Soil Infiltration Testing and Protocol 2. Infiltration Systems Guidelines** should be followed, see Appendix C

Description

Infiltration Basins are shallow, impounded areas designed to temporarily store and infiltrate stormwater runoff. The size and shape can vary from one large basin to multiple, smaller basins throughout a site. Ideally, the basin should avoid disturbance of existing vegetation. If disturbance is unavoidable, replanting and landscaping may be necessary and should integrate the existing landscape as subtly as possible and compaction of the soil must be prevented (see Infiltration Guidelines). Infiltration Basins use the existing soil mantle to reduce the volume of stormwater runoff by infiltration and evapotranspiration. The quality of the runoff is also improved by the natural cleansing processes of the existing soil mantle and also by the vegetation planted in the basins. The key to promoting infiltration is to provide enough surface area for the volume of runoff to be absorbed to meet the criteria in Chapter 3. An engineered overflow structure should be provided for the larger storms.

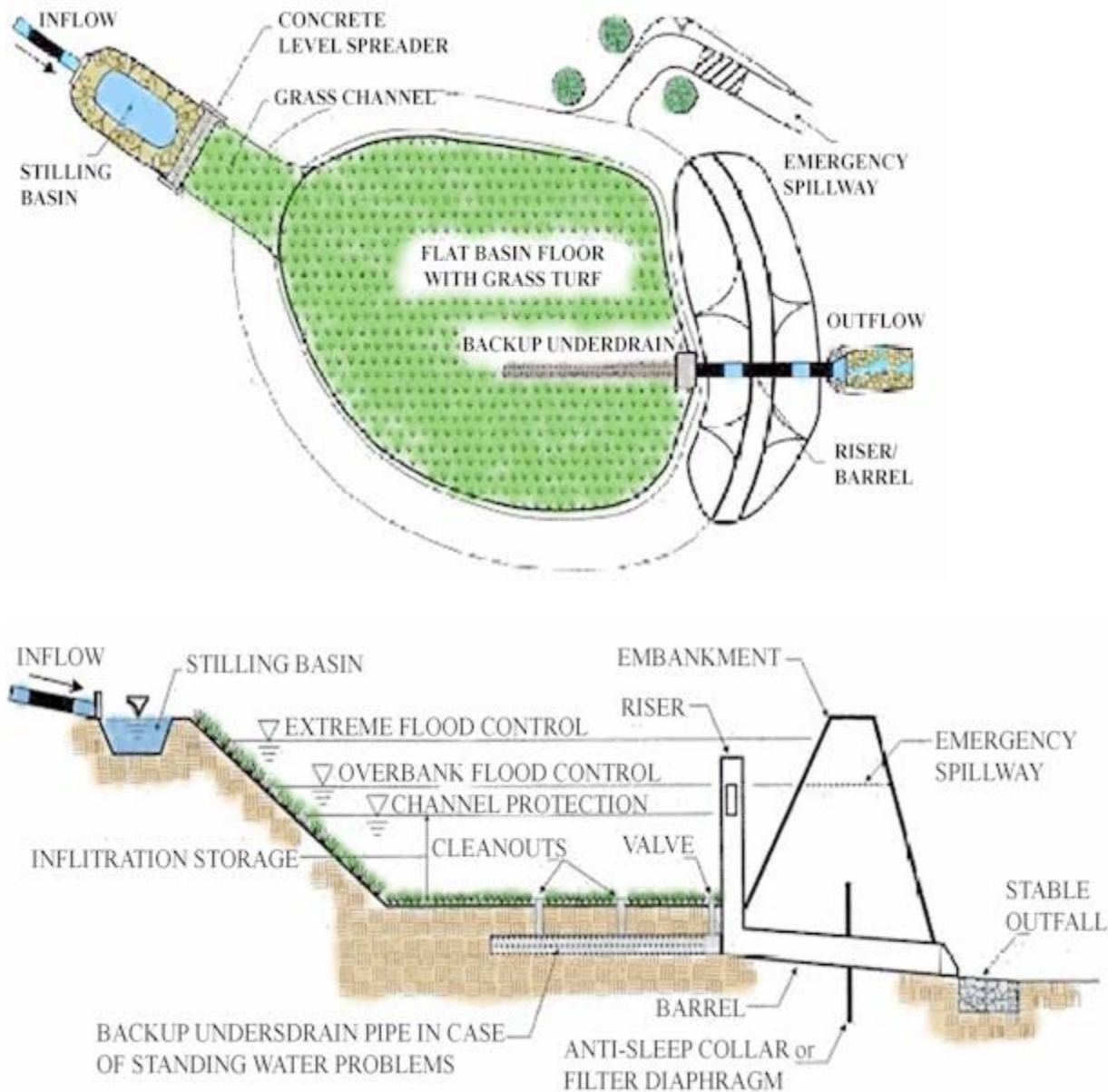

Variations

- **Re-Vegetation**
For existing unvegetated areas or for infiltration basins that require excavation, vegetation may be added. Planting in the infiltration area will improve water quality, encourage infiltration, and promote evapotranspiration. This vegetation may range from a meadow mix to more substantial woodland species. The planting plan should be sensitive to hydrologic variability anticipated in the basin, as well as to larger issues of native plants and habitat, aesthetics, and other planting objectives. **The use of turf grass is discouraged** due to soil compaction from the required frequent mowing and maintenance requirements.
- **Usable Surface**
An Infiltration Basin can be used for recreation (usually informal) in dry periods. Heavy machinery and/or vehicular traffic of any type should be avoided so as not to compact the infiltration area.
- **Soils with Poor Infiltration Rates**
A layer of sand (6") or gravel can be placed on the bottom of the Infiltration Basin, or the soil can be amended to increase the surface permeability of the basin. (See Soil Amendment & Restoration BMP 6.7.3 for details.)

Applications

- **New Development**
Infiltration Basins can be incorporated into new development. Ideally, existing vegetation can be preserved and utilized as the infiltration area. Runoff from adjacent buildings and impervious surfaces can be directed into this area, which will "water" the vegetation, thereby increasing evapotranspiration in addition to encouraging infiltration.
- **Retrofitting existing "lawns" and "open space"**
Existing grassed areas can be converted to infiltration basins. If the soil and infiltration capacity is determined to be sufficient, the area can be enclosed through creation of a berm and runoff can be directed to it without excavation. Otherwise, excavation can be performed as described below.
- **Other Applications**
Other applications of Infiltration Basins may be determined by the Design Professional as appropriate.

Design Considerations

1. Soil Investigation and Infiltration Testing is required; site selection for this BMP should take soil and infiltration capacity into consideration.
2. Guidelines for Infiltration Systems should be met (i.e., depth to water table, setbacks, Loading Rates, etc.)
3. Basin designs that do not remove existing soil and/or vegetation are preferred.

4. The slope of the Infiltration Basin bottom should be level or with a slope no greater than 1%. A level bottom assures even water distribution and infiltration.
5. Basins may be constructed where impermeable soils on the surface are removed and where more permeable underlying soils then are used for the base of the bed; care must be taken in the excavation process to make sure that soil compaction does not occur.
6. The discharge or overflow from the Infiltration Basin should be properly designed for anticipated flows. Large infiltration basins may require multiple outlet control devices to effectively overflow water during the larger storms. See BMP 6.3.3 for more information on overflows and berms.
7. The berms surrounding the basin should be compacted earth with a slope of not steeper than 3:1(H:V), and a top width of at least 2 feet.
8. At least one foot of freeboard above the 100-year storm water elevation should be maintained.
9. Infiltration basins can be planted with natural grasses, meadow mix, or other “woody” mixes, such as trees or shrubs. These plants have longer roots than traditional grass and increase soil permeability. Native plants should be used wherever possible.
10. Use of fertilizer should be avoided.
11. The surface should be compacted as little as possible to allow for surface percolation through the soil layer.
12. When directing runoff from roadway areas into the basin, measures to reduce sediment should be used.
13. The inlets into the basin should have erosion protection.
14. Contributing inlets (up gradient) may have a sediment trap or water quality insert to prevent large particles from clogging the system based on the quality of the runoff.
15. Use of a backup underdrain or low-flow orifice may be considered in the event that the water in the basin does not drain within the criteria in Chapter 3. This underdrain valve should remain in the shut position unless the basin does not drain.

Detailed Stormwater Functions

Infiltration Area

The loading rate guidelines in Appendix C should be consulted
The Infiltration Area is the bottom area of the bed.

Volume Reduction Calculations

$$\text{Volume} = \text{Depth}^* (\text{ft}) \times \text{Area} (\text{sf})$$

*Depth is the depth of the water stored during a storm event, depending on the drainage area and conveyance to the bed.

$$\text{Infiltration Volume} = \text{Bed Bottom Area} (\text{sf}) \times \text{Infiltration design rate} (\text{in/hr}) \times \text{Infiltration period}^* (\text{hr}) \times (1/12)$$

*Infiltration Period is equal to 2 hours or the time of concentration, whichever is larger.

Peak Rate Mitigation Calculations: See Chapter 8 for Peak Rate Mitigation methodology which addresses link between volume reduction and peak rate control.

Water Quality Improvement: See Chapter 8 for Water Quality Improvement methodology, which addresses pollutant removal effectiveness of this BMP.

Construction Sequence

1. Protect Infiltration basin area from compaction prior to installation.
2. If possible, install Infiltration basin during later phases of site construction to prevent sedimentation and/or damage from construction activity. After installation, prevent sediment-laden water from entering inlets and pipes.
3. Install and maintain proper Erosion and Sediment Control Measures during construction.
4. If necessary, excavate Infiltration basin bottom to an uncompacted subgrade free from rocks and debris. Do NOT compact subgrade.
5. Install Outlet Control Structures.
6. Seed and stabilize topsoil. (Vegetate if appropriate with native plantings.)
7. Do not remove Inlet Protection or other Erosion and Sediment Control measures until site is fully stabilized.

Maintenance and Inspection Issues

- Catch Basins and Inlets (upgradient of infiltration basin) should be inspected and cleaned at least two times per year and after runoff events.
- The vegetation along the surface of the Infiltration basin should be maintained in good condition, and any bare spots revegetated as soon as possible.
- Vehicles should not be parked or driven on an Infiltration Basin, and care should be taken to avoid excessive compaction by mowers.
- Inspect the basin after runoff events and make sure that runoff drains down within 72 hours. Mosquito’s should not be a problem if the water drains in 72 hours. Mosquitoes require a

considerably long breeding period with relatively static water levels.

- Also inspect for accumulation of sediment, damage to outlet control structures, erosion control measures, signs of water contamination/spills, and slope stability in the berms.
- Mow only as appropriate for vegetative cover species.
- Remove accumulated sediment from basin as required. Restore original cross section and infiltration rate. Properly dispose of sediment.

Cost Issues

The construction cost of Infiltration Basins can vary greatly depending on the configuration, location, site-specific conditions, etc.

Excavation (if necessary) - varies

Plantings - Meadow mix \$2500 - \$3500 / acre (2005)

Pipe Configuration – varies with stormwater configuration, may need to redirect pipes into the infiltration basin.

Specifications

The following specifications are provided for information purposes only. These specifications include information on acceptable materials for typical applications, but are by no means exclusive or limiting. The designer is responsible for developing detailed specifications for individual design projects in accordance with the project conditions.

1. **Topsoil** amend with compost if necessary or desired. (See Soil Amendment & Restoration BMP 6.7.2)

2. **Vegetation** See Native Plant List available locally, and/or see Appendix B.

References

Michigan Department of Environmental Quality. *Index of Individual BMPs*. 2004. State of Michigan. <
http://www.michigan.gov/deq/1,1607,7-135-3313_3682_3714-13186—,00.html>

Young, et. al., "Evaluation and Management of Highway Runoff Water Quality," Federal Highway Administration, 1996

California Stormwater Quality Association. *California Stormwater Best Management Practices Handbook: New Development and Redevelopment*. 2003.

Metropolitan Council Environmental Services. *Minnesota Urban Small Sites BMP Manual*. 2001.

New Jersey Department of Environmental Protection. *New Jersey Stormwater Best Management Practices Manual*. 2004.

BMP 6.4.3: Subsurface Infiltration Bed



Subsurface Infiltration Beds provide temporary storage and infiltration of stormwater runoff by placing storage media of varying types beneath the proposed surface grade. Vegetation will help to increase the amount of evapotranspiration taking place.

<p style="text-align: center;"><u>Key Design Elements</u></p> <ul style="list-style-type: none"> ▪ Maintain a minimum 2-foot separation to bedrock and seasonally high water table, provide distributed infiltration area (5:1 impervious area to infiltration area - maximum), site on natural, uncompacted soils with acceptable infiltration capacity, and follow other guidelines described in Protocol 2: Infiltration Systems Guidelines ▪ Beds filled with stone (or alternative) as needed to increase void space ▪ Wrapped in nonwoven geotextile ▪ Level or nearly level bed bottoms ▪ Provide positive stormwater overflow from beds ▪ Protect from sedimentation during construction ▪ Provide perforated pipe network along bed bottom for distribution as necessary ▪ Open-graded, clean stone with minimum 40% void space ▪ Do not place bed bottom on compacted fill • Allow 2 ft. buffer between bed bottom and seasonal high groundwater table and 2 ft. for bedrock. 	<p style="text-align: center;"><u>Potential Applications</u></p> <p>Residential: Yes Commercial: Yes Ultra Urban: Yes Industrial: Yes Retrofit: Yes Highway/Road: Limited</p>
	<p style="text-align: center;"><u>Stormwater Functions</u></p> <p>Volume Reduction: High Recharge: High Peak Rate Control: Med./High Water Quality: High</p>
	<p style="text-align: center;"><u>Water Quality Functions</u></p> <p>TSS: 85% TP: 85% NO3: 30%</p>

Other Considerations

- **Protocol 1. Site Evaluation and Soil Infiltration Testing** and **Protocol 2. Infiltration Systems Guidelines** should be followed, see Appendix C

Description

A Subsurface Infiltration Bed generally consists of a vegetated, highly pervious soil media underlain by a uniformly graded aggregate (or alternative) bed for temporary storage and infiltration of stormwater runoff. Subsurface Infiltration beds are ideally suited for expansive, generally flat open spaces, such as lawns, meadows, and playfields, which are located downhill from nearby impervious areas. Subsurface Infiltration Beds can be stepped or terraced down sloping terrain provided that the base of the bed remains level. Stormwater runoff from nearby impervious areas (including rooftops, parking lots, roads, walkways, etc.) can be conveyed to the subsurface storage media, where it is then distributed via a network of perforated piping.

The storage media for subsurface infiltration beds typically consists of clean-washed, uniformly graded aggregate. However, other storage media alternatives are available. These alternatives are generally variations on plastic cells that can more than double the storage capacity of aggregate beds, at a substantially increased cost. Storage media alternatives are ideally suited for sites where potential infiltration area is limited.

If designed, constructed, and maintained as per the following guidelines, Subsurface Infiltration features can stand-alone as significant stormwater runoff volume, rate, and quality control practices. These systems can also maintain aquifer recharge, while preserving or creating valuable open space and recreation areas. They have the added benefit of functioning year-round, given that the infiltration surface is typically below the frost line.

Variations

As its name suggests, Subsurface Infiltration is generally employed for temporary storage and infiltration of runoff in subsurface storage media. However, in some cases, runoff may be temporarily stored on the surface (to depths less than 6 inches) to enhance volume capacity of the system. The overall system design should ensure that within the criteria in Chapter 3, the bed is completely empty.

Applications

Connection of Roof Leaders

Runoff from nearby roofs may be directly conveyed to subsurface beds via roof leader connections to perforated piping. Roof runoff generally has relatively low sediment levels, making it ideally suited for connection to an infiltration bed. However, cleanout(s) with a sediment sump are still recommended between the building and infiltration bed.

Connection of Inlets

Catch Basins, inlets, and area drains may be connected to Subsurface Infiltration beds. However, sediment and debris removal should be provided. Storm structures should therefore include sediment trap areas below the inverts of discharge pipes to trap solids and debris. In areas of high traffic or excessive generation of sediment, litter, and other similar materials, a water quality insert or other pretreatment device may be needed.

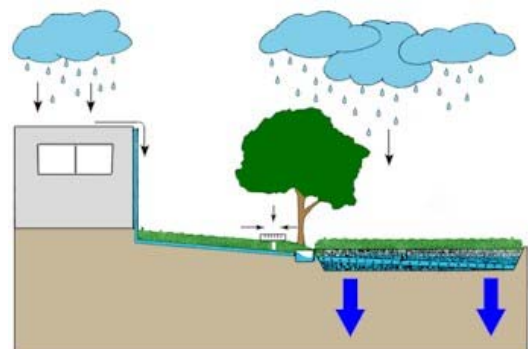

Under Recreational Fields

Subsurface Infiltration is very well suited below playfields and other recreational areas. Special consideration should be given to the engineered soil mix in those cases.

Under Open Space

Subsurface Infiltration is also appropriate in either existing or proposed open space areas. Ideally, these areas are vegetated with native grasses and/or vegetation to enhance site aesthetics and landscaping. Aside from occasional clean-outs or outlet structures, Subsurface Infiltration systems are essentially hidden stormwater management features, making them ideal for open space locations (deed-restricted open space locations are especially desirable because such locations minimize the chance that Subsurface Infiltration systems will be disturbed or disrupted accidentally in the future).



Other Applications

Other applications of Subsurface Infiltration beds may be determined by the Design Professional as appropriate.

Design Considerations

1. Soil Investigation and Infiltration Testing is needed (Appendix C).
2. Guidelines for Infiltration Systems should be met (Appendix C).
3. The overall site should be evaluated for potential Subsurface Infiltration areas early in the design process, as effective design requires consideration of existing site characteristics (topography, natural features/drainage ways, soils, geology, etc.).
4. Control of Sediment is critical. Rigorous installation and maintenance of erosion and sediment control measures is needed to prevent sediment deposition within the stone bed. Nonwoven geotextile may be folded over the edge of the bed until the site is stabilized.
5. The Infiltration bed should be wrapped in non-woven geotextile filter fabric.
6. Subsurface Infiltration areas should not be placed on areas of recent fill or compacted fill. Any grade adjustments requiring fill should be done using the stone subbase material, or alternative. Areas of historical fill (>5 years) may be considered if other criteria are met.



7. The subsurface infiltration bed is typically comprised of a 12 to 36 inch section of aggregate, such as AASHTO No.3, which ranges 1-2 inches in gradation. Depending on local aggregate availability, both larger and smaller size aggregate has been used. The critical requirements are that the aggregate be uniformly graded, clean-washed, and contain at least 40% void space. The depth of the bed is a function of stormwater storage requirements, frost depth considerations, and site grading. Infiltration beds are typically sized to mitigate the increased runoff volume from the design storm.

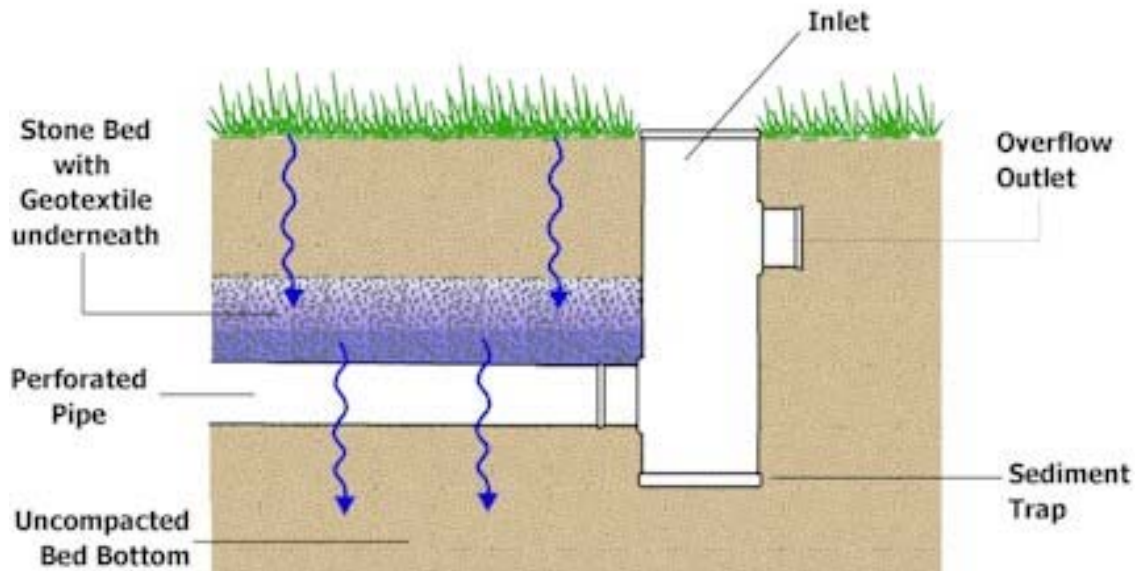

8. Water Quality Inlet or Catch Basin with Sump is needed for all surface inlets, should be designed to avoid standing water for periods greater than the criteria in Chapter 3.
9. Infiltration beds may be placed on a slope by benching or terracing infiltration levels. The slope of the infiltration bed bottom should be level or with a slope no greater than 1%. A level bottom assures even water distribution and infiltration.
10. Perforated pipes along the bottom of the bed can be used to evenly distribute runoff over the entire bed bottom. Continuously perforated pipes may connect structures (such as cleanouts and inlet boxes). Pipes should lay flat along the bed bottom and provide for uniform distribution of water. Depending on size, these pipes may provide additional storage volume.
11. Cleanouts or inlets should be installed at a few locations within the bed and at appropriate intervals to allow access to the perforated piping network and or storage media.
12. All infiltration beds should be designed with an overflow for extreme storm events. Control in the beds is usually provided in the form of an outlet control structure. A modified inlet box with an internal concrete weir (or weir plate) and low-flow orifice is a common type of control structure. The specific design of these structures may vary, depending on factors such as rate and storage requirements, but it must always include positive overflow from the system. The overflow structure is used to maximize the water level in the stone bed, while providing sufficient cover for overflow pipes. Generally, the top of the outlet pipe should be 4 inches below the top of the aggregate to prevent saturated soil conditions in remote areas of the bed. As with all

infiltration practices, multiple discharge points are recommended. These may discharge to the surface or a storm sewer system.

13. Adequate soil cover (generally 12 - 18 inches) should be maintained above the infiltration bed to allow for a healthy vegetative cover.
14. Open space overlying infiltration beds can be vegetated with native grasses, meadow mix, or other low-growing, dense vegetation. These plants have longer roots than traditional grass and will likely benefit from the moisture in the infiltration bed, improving the growth of these plantings and, potentially increasing evapotranspiration.
15. Fertilizer use should be minimized.
16. The surface (above the stone bed) should be compacted as minimally as possible to allow for surface percolation through the engineered soil layer and into the stone bed.
17. When directing runoff from roadway areas into the beds, measures to reduce sediment should be used.
18. Surface grading should be relatively flat, although a relatively mild slope between 1% and 3% is recommended to facilitate drainage.
19. In those areas where the threat of spills and groundwater contamination exists, pretreatment systems, such as filters and wetlands, may be needed before any infiltration occurs. In Hot Spot areas, such as truck stops and fueling stations, the suitability of Subsurface Infiltration must be considered.
20. In areas with poorly-draining soils, Subsurface Infiltration areas may be designed to slowly discharge to adjacent wetlands or bioretention areas.
21. While most Subsurface Infiltration areas consist of an aggregate storage bed, alternative subsurface storage products may also be employed. These include a variety of proprietary, interlocking plastic units that contain much greater storage capacity than aggregate, at an increased cost.
22. The subsurface bed and overflow may be designed and evaluated in the same manner as a detention basin to demonstrate the mitigation of peak flow rates. In this manner, detention basins may be eliminated or significantly reduced in size.
23. During Construction, the excavated bed may serve as a Temporary Sediment Basin or Trap. This can reduce overall site disturbance. The bed should be excavated to at least 1 foot above the final bed bottom elevation for use as a sediment trap or basin. Following construction and site stabilization, sediment should be removed and final grades established. In BMPs that will be used for infiltration in the future, use of construction equipment should be limited as much as possible.

Detailed Stormwater Functions

Infiltration Area

Loading rate guidelines in Appendix C should be consulted.

The Infiltration Area is the bottom area of the bed, defined as:

Length of bed x Width of bed = Infiltration Area (if rectangular)

Volume Reduction Calculations

Volume = Depth* (ft) x Area (sf) x Void Space

*Depth is the depth of water stored during a storm event, depending on the drainage area and conveyance to the bed.

Infiltration Volume = Bed Bottom Area (sf) x Infiltration design rate (in/hr)
x Infiltration period* (hr) x (1/12)

*Infiltration Period is equal to 2 hours or the time of concentration, whichever is larger.

Additional storage/volume reduction can be calculated for the overlying soil as appropriate.

Peak Rate Mitigation Calculations

See in Chapter 8 for Peak Rate Mitigation methodology which addresses link between volume reduction and peak rate control.

Water Quality Improvement: See in Chapter 8 for Water Quality Improvement methodology, which addresses pollutant removal effectiveness of this BMP.

Construction Sequence

1. Due to the nature of construction sites, Subsurface Infiltration should be installed toward the end of the construction period, if possible. (Infiltration beds may be used as temporary sediment basins or traps as discussed above).
2. Install and maintain adequate Erosion and Sediment Control Measures (as per the Pennsylvania Erosion and Sedimentation Control Program Manual) during construction.
3. The existing subgrade under the bed areas should NOT be compacted or subject to excessive construction equipment traffic prior to geotextile and stone bed placement.
4. Where erosion of subgrade has caused accumulation of fine materials and/or surface ponding, this material should be removed with light equipment and the underlying soils scarified to a minimum depth of 6 inches with a York rake (or equivalent) and light tractor. All fine grading should be done by hand. All bed bottoms should be at level grade.
5. Earthen berms (if used) between infiltration beds should be left in place during excavation. These berms do not require compaction if proven stable during construction.

6. Install upstream and downstream control structures, cleanouts, perforated piping, and all other necessary stormwater structures.
7. Geotextile and bed aggregate should be placed immediately after approval of subgrade preparation and installation of structures. Geotextile should be placed in accordance with manufacturer's standards and recommendations. Adjacent strips of geotextile should overlap a minimum of 16 inches. It should also be secured at least 4 feet outside of bed in order to prevent any runoff or sediment from entering the storage bed. This edge strip should remain in place until all bare soils contiguous to beds are stabilized and vegetated. As the site is fully stabilized, excess geotextile along bed edges can be cut back to the edge of the bed.
8. Clean-washed, uniformly graded aggregate should be placed in the bed in maximum 8-inch lifts. Each layer should be lightly compacted, with construction equipment kept off the bed bottom as much as possible.
9. Approved soil media should be placed over infiltration bed in maximum 6-inch lifts.
10. Seed and stabilize topsoil.
11. Do not remove inlet protection or other Erosion and Sediment Control measures until site is fully stabilized.

Maintenance Issues

Subsurface Infiltration is generally less maintenance intensive than other practices of its type. Generally speaking, vegetation associated with Subsurface Infiltration practices is less substantial than practices such as Recharge Gardens and Vegetated Swales and therefore requires less maintenance. Maintenance activities required for the subsurface bed are similar to those of any infiltration system and focus on regular sediment and debris removal. The following represents the recommended maintenance efforts:

- All Catch Basins and Inlets should be inspected and cleaned at least 2 times per year.
- The overlying vegetation of Subsurface Infiltration features should be maintained in good condition, and any bare spots revegetated as soon as possible.
- Vehicular access on Subsurface Infiltration areas should be prohibited, and care should be taken to avoid excessive compaction by mowers. If access is needed, use of permeable, turf reinforcement should be considered.

Cost Issues

The construction cost of Subsurface Infiltration can vary greatly depending on design variations, configuration, location, desired storage volume, and site-specific conditions, among other factors. Typical construction costs are about \$5.70 per square foot, which includes excavation, aggregate (2.0 feet assumed), non-woven geotextile, pipes and plantings.

Specifications

The following specifications are provided for information purposes only. These specifications include information on acceptable materials for typical applications, but are by no means exclusive or limiting. The designer is responsible for developing detailed specifications for individual design projects in accordance with the project conditions.

1. **Stone** for infiltration beds shall be 2-inch to 1-inch uniformly graded coarse aggregate, with a wash loss of no more than 0.5%, AASHTO size number 3 per AASHTO Specifications, Part I, 19th Ed., 1998, or later and shall have voids 40% as measured by ASTM-C29.
2. **Non-Woven Geotextile** shall consist of needled non-woven polypropylene fibers and meet the following properties:

a. Grab Tensile Strength (ASTM-D4632)	120 lbs
b. Mullen Burst Strength (ASTM-D3786)	225 psi
c. Flow Rate (ASTM-D4491)	95 gal/min/ft ²
d. UV Resistance after 500 hrs (ASTM-D4355)	70%
e. Heat-set or heat-calendared fabrics are not permitted	
Acceptable types include Mirafi 140N, Amoco 4547, and Geotex 451.	
3. **Topsoil** may be amended with compost (See soil restoration BMP 6.7.2)
4. **Pipe** shall be continuously perforated, smooth interior, with a minimum inside diameter of 6-inches. High-density polyethylene (HDPE) pipe shall meet AASHTO M252, Type S or AASHTO M294, Type S.
5. **Storm Drain Inlets and Structures**
 - a. Concrete Construction: Concrete construction shall be in accordance with Section 1001, PennDOT Specifications, 1990 or latest edition.
 - b. Precast Concrete Inlets and Manholes: Precast concrete inlets may be substituted for cast-in-place structures and shall be constructed as specified for cast-in-place.

Precast structures may be used in only those areas where there is no conflict with existing underground structures that may necessitate revision of inverts. Type M standard PennDOT inlet boxes will be modified to provide minimum 12 inch sump storage and bottom leaching basins, open to gravel sumps in sub-grade, when situated in the recharge bed.

 - c. All PVC Catch Basins/Cleanouts/Inline Drains shall have H-10 or H-20 rated grates, depending on their placement (H-20 if vehicular loading).
 - d. Steel reinforcing bars over the top of the outlet structure shall conform to ASTM A615, grades 60 and 40.
 - e. Permanent turf reinforcement matting shall be installed according to manufacturers' specifications.
6. **Alternative storage media:** Follow appropriate Manufacturers' specifications.
7. **Vegetation** see Local Native Plant List and Appendix B.

BMP 6.4.4: Infiltration Trench



An Infiltration Trench is a “leaky” pipe in a stone filled trench with a level bottom. An Infiltration Trench may be used as part of a larger storm sewer system, such as a relatively flat section of storm sewer, or it may serve as a portion of a stormwater system for a small area, such as a portion of a roof or a single catch basin. In all cases, an Infiltration Trench should be designed with a positive overflow.

<p style="text-align: center;"><u>Key Design Elements</u></p> <ul style="list-style-type: none"> ▪ Continuously perforated pipe set at a minimum slope in a stone filled, level-bottomed trench ▪ Limited in width (3 to 8 feet) and depth of stone (6 feet max. recommended) ▪ Trench is wrapped in nonwoven geotextile (top, sides, and bottom) ▪ Placed on uncompacted soils ▪ Minimum cover over pipe is as per manufacturer. ▪ A minimum of 6" of topsoil is placed over trench and vegetated ▪ Positive Overflow always provided Deed restrictions recommended Not for use in hot spot areas without pretreatment 	<p style="text-align: center;"><u>Potential Applications</u></p> <p>Residential: Yes Commercial: Yes Ultra Urban: Yes Industrial: Yes Retrofit: Yes Highway/Road: Yes</p>
	<p style="text-align: center;"><u>Stormwater Functions</u></p> <p>Volume Reduction: Medium Recharge: High Peak Rate Control: Medium Water Quality: High</p>
	<p style="text-align: center;"><u>Water Quality Functions</u></p> <p>TSS: 85% TP: 85% NO3: 30%</p>

Other Considerations

- **Protocol 1. Site Evaluation and Soil Infiltration Testing** and **Protocol 2. Infiltration Systems Guidelines** should be followed, see Appendix C

Description

An Infiltration Trench is a linear stormwater BMP consisting of a continuously perforated pipe at a minimum slope in a stone-filled trench (Figure 6.4-1). Usually an Infiltration Trench is part of a **conveyance system** and is designed so that large storm events are conveyed through the pipe with some runoff volume reduction. During small storm events, volume reduction may be significant and there may be little or no discharge. All Infiltration Trenches are designed with a **positive overflow** (Figure 6.4-2).

An Infiltration Trench differs from an Infiltration Bed in that it may be constructed without heavy equipment entering the trench. It is also intended to convey some portion of runoff in many storm events.

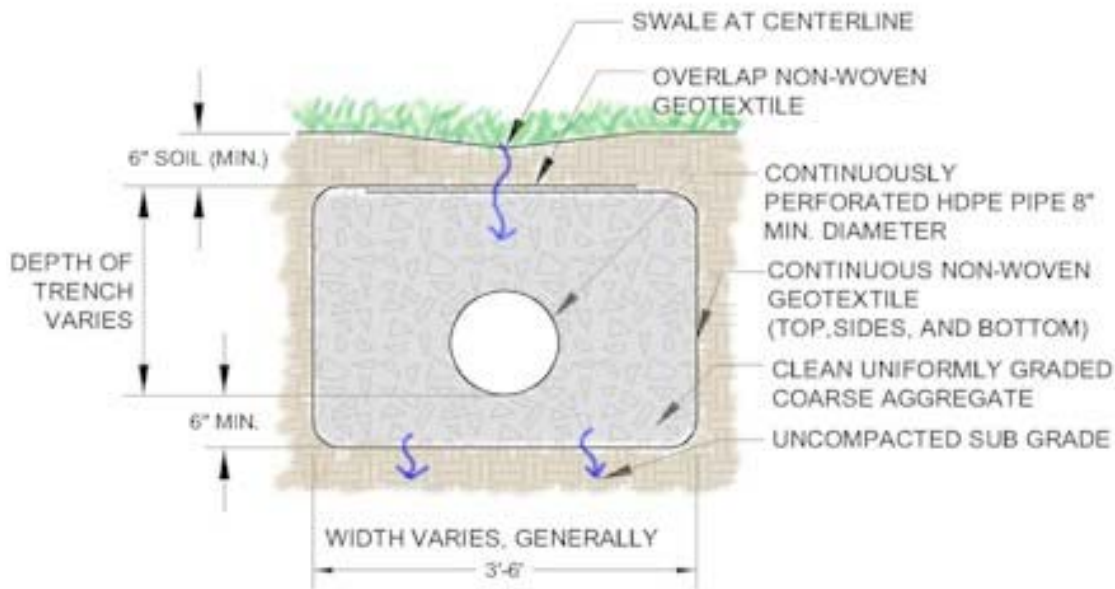

Figure 6.4-1

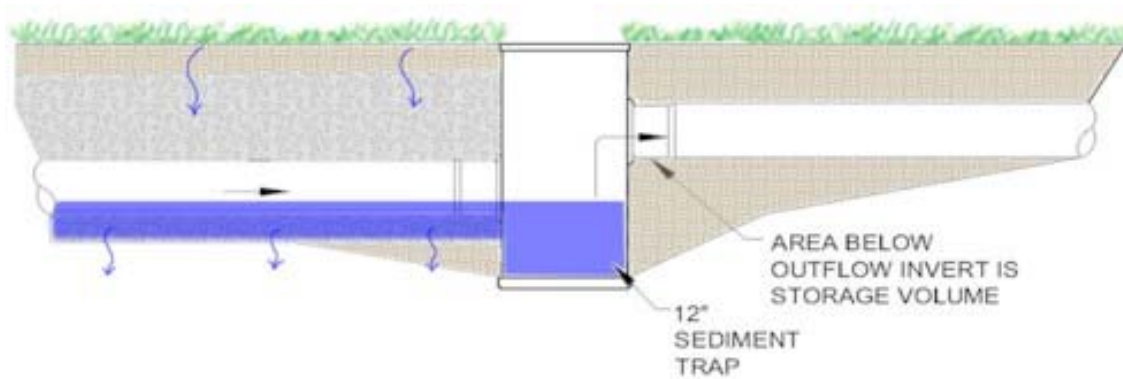

Figure 6.4-2

All Infiltration Trenches should be designed in accordance with Appendix C. Although the width and depth can vary, it is recommended that Infiltration Trenches be limited in depth to not more than six (6)

feet of stone. This is due to both construction issues and Loading Rate issues (as described in the Guidelines for Infiltration Systems). The designer should consider the appropriate depth.

Variations

Infiltration Trenches generally have a vegetated (grassed) or gravel surface. Infiltration Trenches also may be located alongside or adjacent to roadways or impervious paved areas with proper design. The subsurface drainage direction should be to the downhill side (away from subbase of pavement), or located lower than the impervious subbase layer. Proper measures should be taken to prevent water infiltrating into the subbase of impervious pavement.

Infiltration Trenches may also be located down a mild slope by “stepping” the sections between control structures as shown in Figure 6.4-3. A level or nearly level bottom is recommended for even distribution.

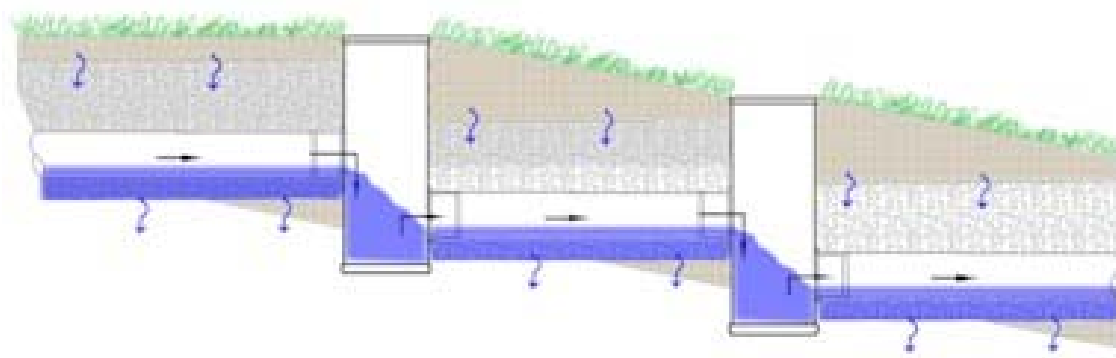

Figure 6.4-3

Applications

- **Connection of Roof Leaders**

Roof leaders may be connected to Infiltration Trenches. Roof runoff generally has lower sediment levels and often is ideally suited for discharge through an Infiltration Trench. A cleanout with sediment sump should be provided between the building and Infiltration Trench.

- **Connection of Inlets**

Catch Basins, inlets and area drains may be connected to Infiltration Trenches, however sediment and debris removal should be addressed. Structures should include a sediment trap area below the invert of the pipe for solids and debris. In areas of high traffic or areas where excessive sediment, litter, and other similar materials may be generated, a water quality insert or other pretreatment device is needed.

- **In Combination with Vegetative Filters**

An Infiltration Trench may be preceded by or used in combination with a Vegetative Filter, Grassed Swale, or other vegetative element used to reduce sediment levels

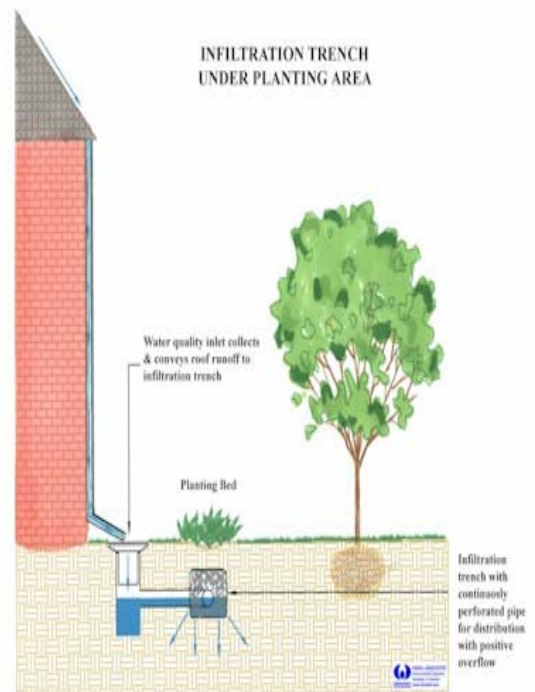

from areas such as high traffic roadways. Design should ensure proper functioning of vegetative system.

- **Other Applications**

Other applications of Infiltration Trenches may be determined by the design professional as appropriate.

Design Considerations

1. Soil Investigation and Percolation Testing is required (see Appendix C, Protocol 2)
2. Guidelines for Infiltration Systems should be met (i.e., depth to water table, setbacks, Loading Rates, etc. See Appendix C, Protocol 1)
3. Water Quality Inlet or Catch Basin with Sump (see Section 6.6.4) recommended for all surface inlets, designed to avoid standing water for periods greater than the criteria in Chapter 3.
4. A continuously perforated pipe should extend the length of the trench and have a positive flow connection designed to allow high flows to be conveyed through the Infiltration Trench.
5. The slope of the Infiltration Trench bottom should be level or with a slope no greater than 1%. The Trench may be constructed as a series of “steps” if necessary. A level bottom assures even water distribution and infiltration.
6. Cleanouts or inlets should be installed at both ends of the Infiltration Trench and at appropriate intervals to allow access to the perforated pipe.
7. The discharge or overflow from the Infiltration Trench should be properly designed for anticipated flows.

Detailed Stormwater Functions

Infiltration Area

The Infiltration Area is the bottom area of the Trench*, defined as:

$$\text{Length of Trench} \times \text{Width of Trench} = \text{Infiltration Area (Bottom Area)}$$

This is the area to be considered when evaluating the Loading Rate to the Infiltration Trench.

* Some credit can be taken for the side area that is frequently inundated as appropriate.

Volume Reduction Calculations

$$\text{Volume} = \text{Depth}^* (\text{ft}) \times \text{Area} (\text{sf}) \times \text{Void Space}$$

*Depth is the depth of the water surface during a storm event, depending on the drainage area and conveyance to the bed.

$$\text{Infiltration Volume} = \text{Bed Bottom Area} (\text{sf}) \times \text{Infiltration design rate} (\text{in/hr}) \times \text{Infiltration period}^* (\text{hr}) \times (1/12)$$

*Infiltration Period is the time when bed is receiving runoff and capable of infiltration. Not to exceed 72 hours.

The void ratio in stone is approximately 40% for AASTO No 3. If the conveyance pipe is within the Storage Volume area, the volume of the pipe may also be included. All Infiltration Trenches should be designed to infiltrate or empty within 72 hours.

Peak Rate Mitigation Calculations

See Chapter 8 for Peak Rate Mitigation methodology which addresses link between volume reduction and peak rate control.

Water Quality Improvement

See Chapter 8 for Water Quality Improvement methodology which addresses pollutant removal effectiveness of this BMP.

Construction Sequence

1. Protect Infiltration Trench area from compaction prior to installation.
2. If possible, install Infiltration Trench during later phases of site construction to prevent sedimentation and/or damage from construction activity. After installation, prevent sediment laden water from entering inlets and pipes.
3. Install and maintain proper Erosion and Sediment Control Measures during construction.
4. Excavate Infiltration Trench bottom to a uniform, level uncompacted subgrade free from rocks and debris. Do NOT compact subgrade.
5. Place nonwoven geotextile along bottom and sides of trench*. Nonwoven geotextile rolls should overlap by a minimum of 16 inches within the trench. Fold back and secure excess geotextile during stone placement.
6. Install upstream and downstream Control Structures, cleanouts, etc.
7. Place uniformly graded, clean-washed aggregate in 8-inch lifts, lightly compacting between lifts.
8. Install Continuously Perforated Pipe as indicated on plans. Backfill with uniformly graded, clean-washed aggregate in 8-inch lifts, lightly compacting between lifts.
9. Fold and secure nonwoven geotextile over Infiltration Trench, with minimum overlap of 16-inches.
10. Place 6-inch lift of approved Topsoil over Infiltration Trench, as indicated on plans.
11. Seed and stabilize topsoil.
12. Do not remove Inlet Protection or other Erosion and Sediment Control measures until site is fully stabilized.
13. Any sediment that enters inlets during construction is to be removed within 24 hours.





(from left to right) Installation of Inlets and Control Structure; Non-woven Geotextile is folded over Infiltration Trench; Stabilized Site



(Clockwise from top left) Infiltration Trench is on downhill side of roadway; Infiltration Trench is installed; Infiltration Trench is paved with standard pavement material

Maintenance and Inspection Issues

- Catch Basins and Inlets should be inspected and cleaned at least 2 times per year.
- The vegetation along the surface of the Infiltration Trench should be maintained in good condition, and any bare spots revegetated as soon as possible.
- Vehicles should not be parked or driven on a vegetated Infiltration Trench, and care should be taken to avoid excessive compaction by mowers.

Cost Issues

The construction cost of infiltration trenches can vary greatly depending on the configuration, location, site-specific conditions, etc. Typical construction costs in 2003 dollars range from \$4 - \$9 per cubic foot of storage provided (SWRPC, 1991; Brown and Schueler, 1997). Annual maintenance costs have been reported to be approximately 5 to 10 percent of the capital costs (Schueler, 1987).

Specifications

The following specifications are provided for information purposes only. These specifications include information on acceptable materials for typical applications, but are by no means exclusive or limiting. The designer is responsible for developing detailed specifications for individual design projects in accordance with the project conditions.

1. Stone for infiltration trenches shall be 2-inch to 1-inch uniformly graded coarse aggregate, with a wash loss of no more than 0.5%, AASHTO size number 3 per AASHTO Specifications, Part I, 19th Ed., 1998, or later and shall have voids 40% as measured by ASTM-C29.

2. Non-Woven Geotextile shall consist of needled nonwoven polypropylene fibers and meet the following properties:

- a. Grab Tensile Strength (ASTM-D4632)
 - b. Mullen Burst Strength (ASTM-D3786)
 - c. Flow Rate (ASTM-D4491)
 - d. UV Resistance after 500 hrs (ASTM-D4355) 70%
 - e. Heat-set or heat-calendared fabrics are not permitted
- Acceptable types include Mirafi 140N, Amoco 4547, and Geotex 451.

3. Pipe shall be continuously perforated, smooth interior, with a minimum inside diameter of 8-inches. High-density polyethylene (HDPE) pipe shall meet AASHTO M252, Type S or AASHTO M294, Type S.

References

Brown and Schueler, *Stormwater Management Fact Sheet: Infiltration Trench*. 1997.

Schueler, T., 1987. *Controlling urban runoff: a practical manual for planning and designing urban BMPs*, Metropolitan Washington Council of Governments, Washington, DC

SWRPC, The Use of of Best Management Practices (BMPs) in Urban Watersheds, US Environmental Protection Agency, 1991.

BMP 6.4.5: Rain Garden/Bioretention

RECHARGE GARDEN / BIORETENTION BED

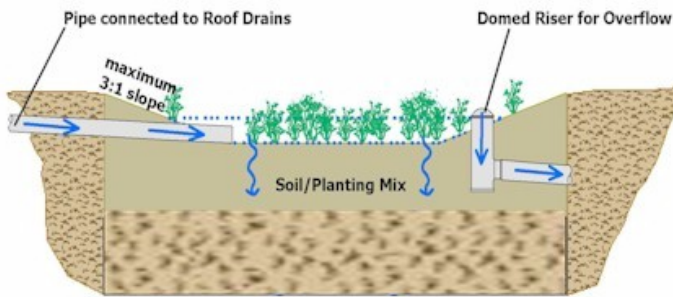

A Rain Garden (also called Bioretention) is an excavated shallow surface depression planted with specially selected native vegetation to treat and capture runoff.

<p style="text-align: center;"><u>Key Design Elements</u></p> <ul style="list-style-type: none"> ▪ Flexible in terms of size and infiltration ▪ Ponding depths generally limited to 12 inches or less for aesthetics, safety, and rapid draw down. Certain situations may allow deeper ponding depths. ▪ Deep rooted perennials and trees encouraged ▪ Native vegetation that is tolerant of hydrologic variability, salts and environmental stress ▪ Modify soil with compost. ▪ Stable inflow/outflow conditions ▪ Provide positive overflow ▪ Maintenance to ensure long-term functionality 	<p style="text-align: center;"><u>Potential Applications</u></p> <p>Residential: Yes Yes Commercial: Ultra Yes Urban: Industrial: Yes Yes Retrofit: Yes Highway/Road: Yes</p>
	<p style="text-align: center;"><u>Stormwater Functions</u></p> <p>Volume Reduction: Medium Recharge: Med./High Peak Rate Control: Low/Med. Water Quality: Med./High</p>
	<p style="text-align: center;"><u>Water Quality Functions</u></p> <p>TSS: TP: 85% 85% NO3: 30%</p>

Other Considerations

- **Protocol 1. Site Evaluation and Soil Infiltration Testing** and **Protocol 2. Infiltration Systems Guidelines** should be followed, see Appendix C

Description

Bioretention is a method of treating stormwater by pooling water on the surface and allowing filtering and settling of suspended solids and sediment at the mulch layer, prior to entering the plant/soil/microbe complex media for infiltration and pollutant removal. Bioretention techniques are used to accomplish water quality improvement and water quantity reduction. Prince George’s County, Maryland, and Alexandria, Virginia have used this BMP since 1992 with success in many urban and suburban settings.

Bioretention can be integrated into a site with a high degree of flexibility and can balance nicely with other structural management systems, including porous asphalt parking lots, infiltration trenches, as well as non-structural stormwater BMPs described in Chapter 5.

The vegetation serves to filter (water quality) and transpire (water quantity) runoff, and the root systems can enhance infiltration. The plants take up pollutants; the soil medium filters out pollutants and allows storage and infiltration of stormwater runoff; and the bed provides additional volume control. Properly designed bioretention techniques mimic natural ecosystems through species diversity, density and distribution of vegetation, and the use of native species, resulting in a system that is resistant to insects, disease, pollution, and climatic stresses.

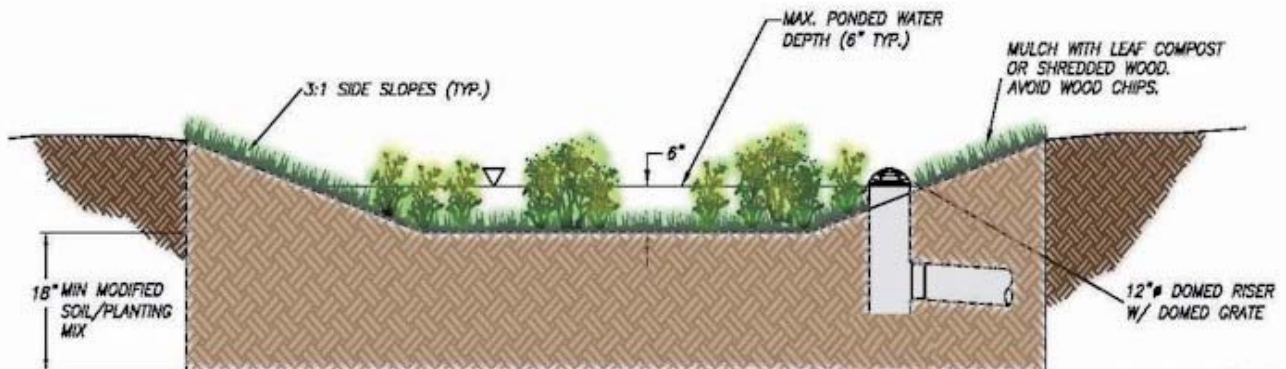

Rain Gardens / Bioretention function to:

- Reduce runoff volume
- Filter pollutants, through both soil particles (which trap pollutants) and plant material (which take up pollutants)
- Recharge groundwater by infiltration
- Reduce stormwater temperature impacts
- Enhance evapotranspiration
- Enhance aesthetics
- Provide habitat

Primary Components of a Rain Garden/Bioretention System

The primary components (and subcomponents) of a rain garden/bioretention system are:

Pretreatment (optional)

- Sheet flow through a vegetated buffer strip, cleanout, water quality inlet, etc. prior to entry into the Rain Garden

Flow entrance

- Varies with site use (e.g., parking island versus residential lot applications)
- Water may enter via an inlet (e.g., flared end section)
- Sheet flow into the facility over grassed areas
- Curb cuts with grading for sheet flow entrance
- Roof leaders with direct surface connection
- Trench drain
- Entering velocities should be non-erosive.

Ponding area

- Provides temporary surface storage of runoff
- Provides evaporation for a portion of runoff
- Design depths allow sediment to settle
- Limited in depth for aesthetics and safety

Plant material

- Evapotranspiration of stormwater
- Root development and rhizome community create pathways for infiltration
- Bacteria community resides within the root system creating healthy soil structure with water quality benefits
- Improves aesthetics for site
- Provides habitat for animals and insects
- Reinforces long-term performance of subsurface infiltration
- Should be tolerant of salts if in a location that would receive snow melt chemicals

Organic layer or mulch

- Acts as a filter for pollutants in runoff
- Protects underlying soil from drying and eroding
- Simulates leaf litter by providing environment for microorganisms to degrade organic material
- Provides a medium for biological growth, decomposition of organic material, adsorption and bonding of heavy metals
- Wood mulch should be shredded - compost or leaf mulch is preferred.

Planting soil/volume storage bed

- Provides water/nutrients to plants
- Enhances biological activity and encourages root growth
- Provides storage of stormwater by the voids within the soil particles

Positive overflow

- Will discharge runoff during large storm events when the storage capacity is exceeded. Examples include domed riser, inlet, weir structure, etc.
- An underdrain can be included in areas where infiltration is not possible or appropriate.

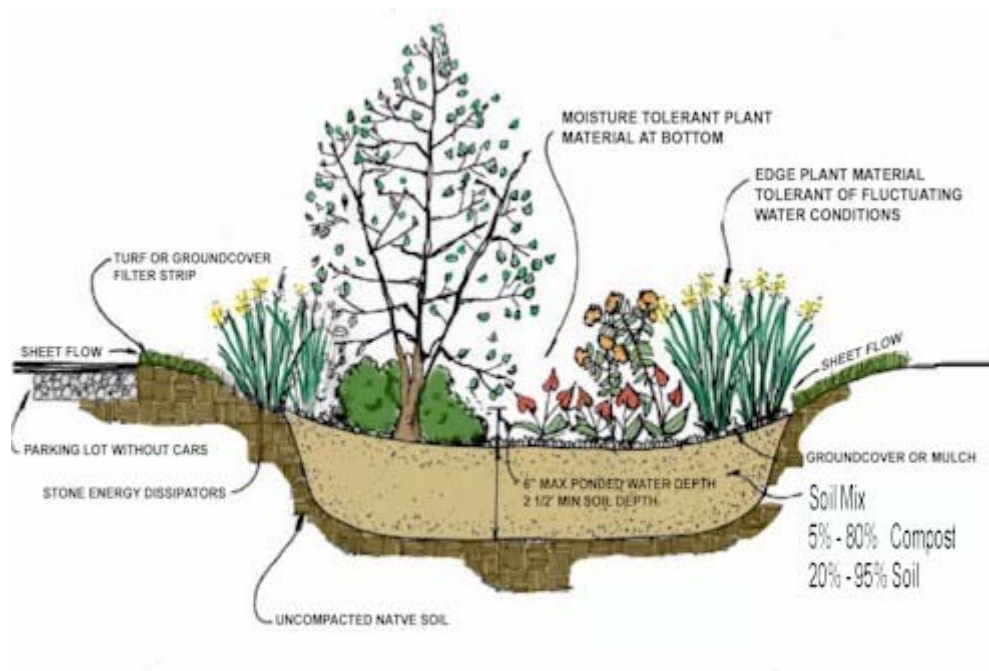

Variations

Generally, a Rain Garden/Bioretention system is a vegetated surface depression that provides for the infiltration of relatively small volumes of stormwater runoff, often managing stormwater on a lot-by-lot basis (versus the total development site). If greater volumes of runoff need to be managed or stored, the system can be designed with an expanded subsurface infiltration bed or the Bioretention area can be increased in size.

The design of a Rain Garden can vary in complexity depending on the quantity of runoff volume to be managed, as well as the pollutant reduction objectives for the entire site. Variations exist both in the components of the systems, which are a function of the land use surrounding the Bioretention system.

The most common variation includes a gravel or sand bed underneath the planting bed. The original intent of this design, however, was to perform as a filter BMP utilizing an under drain and subsequent discharge. When a designer decides to use a gravel or sand bed for volume storage under the planting bed, then additional design elements and changes in the vegetation plantings should be provided.

Flow Entrance: Curbs and Curb Cuts



Flow Entrance: Trench Drain



Positive Overflow: Domed Riser



Positive Overflow: Inlet



Applications

Bioretention areas can be used in a variety of applications: from small areas in residential lawns to extensive systems in large parking lots (incorporated into parking islands and/or perimeter areas).

- Residential On-lot**

Rain Garden (Prince George’s County)

Simple design that incorporates a planting bed in the low portion of the site

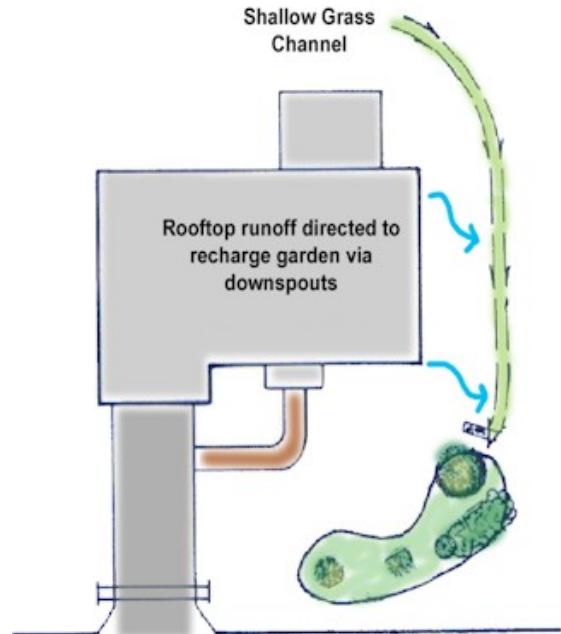

- Tree and Shrub Pits**

Stormwater management technique that intercepts runoff and provides shallow ponding in a dished mulched area around the tree or shrub.

Extend the mulched area to the tree dripline

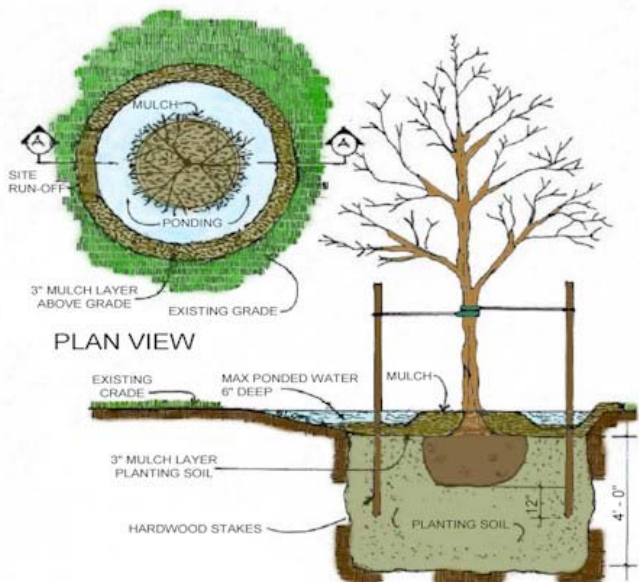

- **Roads and highways**



- **Parking Lots**
- **Parking Lot Island Bioretention**



- **Commercial/Industrial/Institutional**

In commercial, industrial, and institutional situations, stormwater management and greenspace areas are limited, and in these situations, Rain Gardens for stormwater management and landscaping provide multifunctional options.

- **Curbless (Curb cuts) Parking Lot Perimeter Bioretention**

The Rain Garden is located adjacent to a parking area with no curb or curb cuts , allowing stormwater to sheet flow over the parking lot directly into the Rain Garden. Shallow grades should direct runoff at reasonable velocities; this design can be used in conjunction with depression storage for stormwater quantity control.



- **Curbed Parking Lot Perimeter Bioretention**



- **Roof leader connection from adjacent building**



Design Considerations

Rain Gardens are flexible in design and can vary in complexity according to water quality objectives and runoff volume requirements. Though Rain Gardens are a structural BMP, the initial siting of bioretention areas should respect the Integrating Site Design Procedures described in Chapter 4 and integrated with the preventive non-structural BMPs.

It is important to note that bioretention areas are not to be confused with constructed wetlands or wet ponds which permanently pond water. Bioretention is best suited for areas with at least moderate infiltration rates (more than 0.1 inches per hour). In extreme situations where permeability is less than 0.1 inches per hour, special variants may apply, including under drains, or even constructed wetlands.

Rain Gardens are often very useful in retrofit projects and can be integrated into already developed lots and sites. An important concern for all Rain Garden applications is their long-term protection and maintenance, especially if undertaken in multiple residential lots where individual homeowners provide maintenance. In such situations, it is important to provide some sort of management that insures their long-term functioning (deed restrictions, covenants, and so forth).

1. Sizing criteria

- a. **Surface area** is dependent upon storage volume requirements but should generally not exceed a maximum loading ratio of 5:1 (impervious drainage area to infiltration area; see Protocol 2. Infiltration Systems Guidelines (Appendix C) for additional guidance on loading rates.)
- b. **Surface Side slopes** should be gradual. For most areas, maximum 3:1 side slopes are recommended, however where space is limited, 2:1 side slopes may be acceptable.
- c. **Surface Ponding depth** should not exceed 6 inches in most cases and should empty within 72 hours.
- d. **Ponding area** should provide sufficient surface area to meet required storage volume without exceeding the design ponding depth. The subsurface storage/infiltration bed is used to supplement surface storage where feasible.
- e. **Planting soil depth** should generally be at least 18" where only herbaceous plant species will be utilized. If trees and woody shrubs will be used, soil media depth may be increased, depending on plant species.

2. **Planting Soil** should be a loam soil capable of supporting a healthy vegetative cover. Soils should be amended with a composted organic material. A typical organic amended soil is combined with 20-30% organic material (compost), and 70-80% soil base (preferably topsoil). Planting soil should be approximately 4 inches deeper than the bottom of the largest root ball.
3. **Volume Storage Soils** should also have a pH of between 5.5 and 6.5 (better pollutant adsorption and microbial activity), a clay content less than 10% (a small amount of clay is beneficial to adsorb pollutants and retain water), be free of toxic substances and unwanted plant material and have a 5 –10% organic matter content. Additional organic matter can be added to the soil to increase water holding capacity (tests should be conducted to determine volume storage capacity of amended soils).

4. Proper **plant selection** is essential for bioretention areas to be effective. Typically, native floodplain plant species are best suited to the variable environmental conditions encountered. If shrubs and trees are included in a bioretention area (which is recommended), at least three species of shrub and tree should be planted at a rate of approximately 700 shrubs and 300 trees per acre (shrub to tree ratio should be 2:1 to 3:1). An experienced landscape architect is recommended to design native planting layout.
5. **Planting periods** will vary, but in general trees and shrubs should be planted from mid-March through the end of June, or mid-September through mid-November
6. A maximum of 2 to 3 inches of shredded **mulch** or leaf compost (or other comparable product) should be uniformly applied immediately after shrubs and trees are planted to prevent erosion, enhance metal removals, and simulate leaf litter in a natural forest system. Wood chips should be avoided as they tend to float during inundation periods. Mulch / compost layer should not exceed 3" in depth so as not to restrict oxygen flow to roots.
7. Must be designed carefully in areas with **steeper slopes** and should be aligned parallel to contours to minimize earthwork.
8. Under drains should not be used except where in-situ soils fail to drain surface water to meet the criteria in Chapter 3.

Detailed Stormwater Functions

Infiltration Area

Volume Reduction Calculations

The storage volume of a Bioretention area is defined as the sum total of 1. and the smaller of 2a or 2b below. The surface storage volume should account for at least 50% of the total storage. Inter-media void volumes may vary considerably based on design variations.

1. Surface Storage Volume (CF) = Bed Area (ft²) x Average Design Water Depth
- 2a. Infiltration Volume = Bed Bottom area (sq ft) x infiltration design rate (in/hr) x infiltration period (hr) x 1/12.
- 2b. Volume = Bed Bottom area (sq ft) x soil mix bed depth x void space.

Peak Rate Mitigation

See Chapter 8 for Peak Rate Mitigation methodology, which addresses link between volume reduction and peak rate control.

Water Quality Improvement

See Chapter 8 for Water Quality Improvement methodology, which addresses pollutant removal effectiveness of this BMP.

Construction Sequence

The following is a typical construction sequence; however, alterations might be necessary depending on design variations.

1. Install temporary sediment control BMPs as shown on the plans.
2. Complete site grading. If applicable, construct curb cuts or other inflow entrance but provide protection so that drainage is prohibited from entering construction area.
3. Stabilize grading within the limit of disturbance except within the Rain Garden area. Rain garden bed areas may be used as temporary sediment traps provided that the proposed finish elevation of the bed is 12 inches lower than the bottom elevation of the sediment trap.
4. Excavate Rain Garden to proposed invert depth and scarify the existing soil surfaces. Do not compact in-situ soils.
5. Backfill Rain Garden with amended soil as shown on plans and specifications. Overfilling is recommended to account for settlement. Light hand tamping is acceptable if necessary.
6. Presoak the planting soil prior to planting vegetation to aid in settlement.
7. Complete final grading to achieve proposed design elevations, leaving space for upper layer of compost, mulch or topsoil as specified on plans.
8. Plant vegetation according to planting plan.
9. Mulch and install erosion protection at surface flow entrances where necessary.



Maintenance Issues

Properly designed and installed Bioretention areas require some regular maintenance.

- While vegetation is being established, pruning and weeding may be required.
- Detritus may also need to be removed every year. Perennial plantings may be cut down at the end of the growing season.
- Mulch should be re-spread when erosion is evident and be replenished as needed. Once every 2 to 3 years the entire area may require mulch replacement.
- Bioretention areas should be inspected at least two times per year for sediment buildup, erosion, vegetative conditions, etc.
- During periods of extended drought, Bioretention areas may require watering.
-
- Trees and shrubs should be inspected twice per year to evaluate health.

Cost Issues

Rain Gardens often replace areas that would have been landscaped and are maintenance-intensive so that the net cost can be considerably less than the actual construction cost. In addition, the use of Rain Gardens can decrease the cost for stormwater conveyance systems at a site. Rain Gardens cost approximately \$5 to \$7 (2005) per cubic foot of storage to construct.

Specifications

The following specifications are provided for informational purposes only. These specifications include information on acceptable materials for typical applications, but are by no means exclusive or limiting. The designer is responsible for developing detailed specifications for individual design projects in accordance with the project conditions.

1Vegetation - See Appendix B

2 Execution

a. Subgrade preparation

1. Existing sub-grade in Bioretention areas shall NOT be compacted or subject to excessive construction equipment traffic.
2. Initial excavation can be performed during rough site grading but shall not be carried to within one feet of the final bottom elevation. Final excavation should not take place until all disturbed areas in the drainage area have been stabilized.
3. Where erosion of sub-grade has caused accumulation of fine materials and/or surface ponding in the graded bottom, this material shall be removed with light

equipment and the underlying soils scarified to a minimum depth of 6 inches with a York rake or equivalent by light tractor.

4. Bring sub-grade of bioretention area to line, grade, and elevations indicated. Fill and lightly regrade any areas damaged by erosion, ponding, or traffic compaction. All bioretention areas shall be level grade on the bottom.
 5. Halt excavation and notify engineer immediately if evidence of sinkhole activity or pinnacles of carbonate bedrock are encountered in the bioretention area.
- b. Rain Garden Installation

1. Upon completion of sub-grade work, the Engineer shall be notified and shall inspect at his/her discretion before proceeding with bioretention installation.
2. For the subsurface storage/infiltration bed installation, amended soils should be placed on the bottom to the specified depth.
3. Planting soil shall be placed immediately after approval of sub-grade preparation/bed installation. Any accumulation of debris or sediment that takes place after approval of sub-grade shall be removed prior to installation of planting soil at no extra cost to the Owner.
4. Install planting soil (exceeding all criteria) in 18-inch maximum lifts and lightly compact (tamp with backhoe bucket or by hand). Keep equipment movement over planting soil to a minimum – **do not over compact**. Install planting soil to grades indicated on the drawings.
5. Plant trees and shrubs according to supplier's recommendations and only from mid-March through the end of June or from mid-September through mid-November.
6. Install 2-3" shredded hardwood mulch (minimum age 6 months) or compost mulch evenly as shown on plans. Do not apply mulch in areas where ground cover is to be grass or where cover will be established by seeding.
7. Protect Rain Gardens from sediment at all times during construction. Hay bales, diversion berms and/or other appropriate measures shall be used at the toe of slopes that are adjacent to Rain Gardens to prevent sediment from washing into these areas during site development.
8. When the site is fully vegetated and the soil mantle stabilized the plan designer shall be notified and shall inspect the Rain Garden drainage area at his/her discretion before the area is brought online and sediment control devices removed.
9. Water vegetation at the end of each day for two weeks after planting is completed.

Contractor should provide a one-year 80% care and replacement warranty for all planting beginning after installation and inspection of all plants.

BMP 6.4.6: Dry Well / Seepage Pit

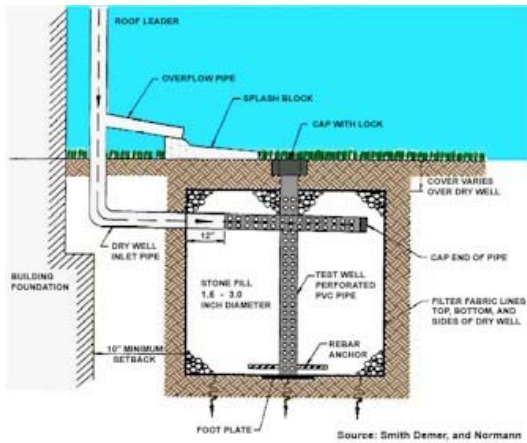

A Dry Well, or Seepage Pit, is a variation on an Infiltration system that is designed to temporarily store and infiltrate rooftop runoff.

<p style="text-align: center;"><u>Key Design Elements</u></p> <ul style="list-style-type: none"> ▪ Follow Infiltration System Guidelines in Appendix C ▪ Maintain minimum distance from building foundation (typically 10 feet) ▪ Provide adequate overflow outlet for large storms ▪ Depth of Dry Well aggregate should be between 18 and 48 inches ▪ At least one observation well; clean out is recommended ▪ Wrap aggregate with nonwoven geotextile ▪ Maintenance will require periodic removal of sediment and leaves from sumps and cleanouts ▪ Provide pretreatment for some situations 	<p style="text-align: center;"><u>Potential Applications</u></p> <p>Residential: Yes Commercial: Yes Ultra Urban: Yes Industrial: Limited Retrofit: Yes Highway/Road: No</p> <hr/> <p style="text-align: center;"><u>Stormwater Functions</u></p> <p>Volume Reduction: Medium Recharge: High Peak Rate Control: Medium Water Quality: Medium</p> <hr/> <p style="text-align: center;"><u>Water Quality Functions</u></p> <p>TSS: TP: 85% 85% NO3: 30%</p>
--	--

Other Considerations

- **Protocol 1. Site Evaluation and Soil Infiltration Testing** and **Protocol 2. Infiltration Systems Guidelines** should be followed, see Appendix C

Description

A Dry Well, sometimes called a Seepage Pit, is a subsurface storage facility that temporarily stores and infiltrates stormwater runoff from the roofs of structures. Roof leaders connect directly into the Dry Well, which may be either an excavated pit filled with uniformly graded aggregate wrapped in geotextile or a prefabricated storage chamber or pipe segment. Dry Wells discharge the stored runoff via infiltration into the surrounding soils. In the event that the Dry Well is overwhelmed in an intense storm event, an overflow mechanism (surcharge pipe, connection to larger infiltration area, etc.) will ensure that additional runoff is safely conveyed downstream.

By capturing runoff at the source, Dry Wells can dramatically reduce the increased volume of stormwater generated by the roofs of structures. Though roofs are generally not a significant source of runoff pollution, they are still one of the most important sources of new or increased runoff volume from developed areas. By decreasing the volume of stormwater runoff, Dry Wells can also reduce runoff rate and improve water quality. As with other infiltration practices, Dry Wells may not be appropriate for “hot spots” or other areas where high pollutant or sediment loading is expected without additional design considerations. Dry Wells are not recommended within a specified distance to structures or subsurface sewage disposal systems. (see Appendix C, Protocol 2)

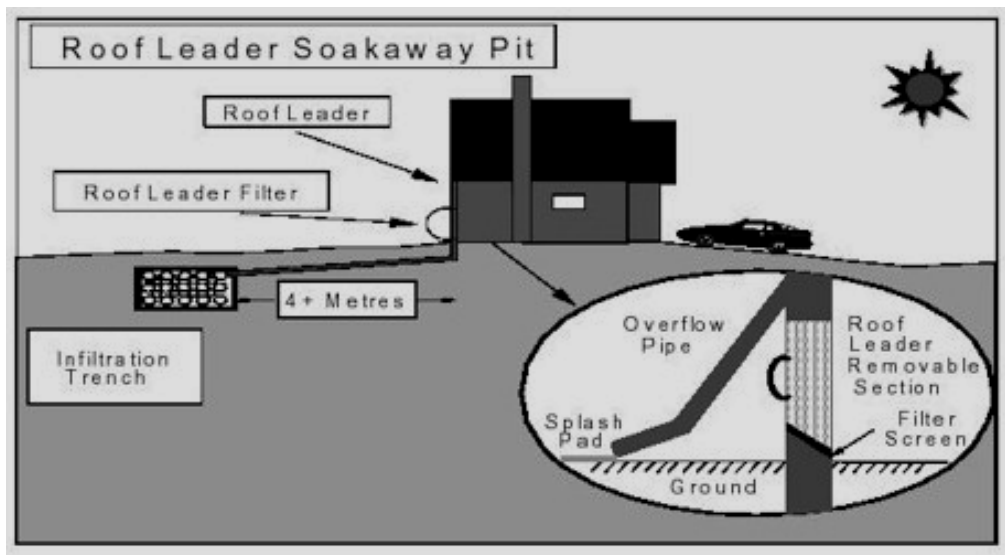

Variations

Intermediate “Sump” Box – Water can flow through an intermediate box with an outflow higher to allow the sediments to settle out. Water would then flow through a mesh screen and into the dry well.

Drain Without Gutters – For structures without gutters or downspouts, runoff is designed to sheetflow off a pitched roof surface and onto a stabilized ground cover (surface aggregate, pavement, or other means). Runoff is then directed toward a Dry Well via stormwater pipes or swales.

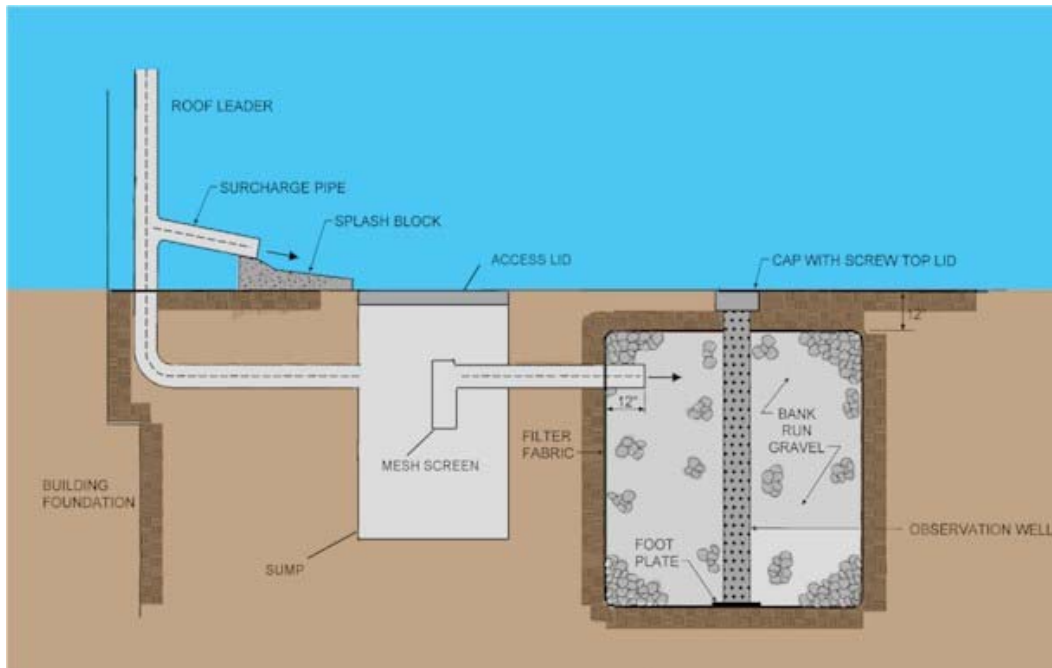

Prefabricated Dry Well – There are a variety of prefabricated, predominantly plastic subsurface storage chambers on the market today that can replace aggregate Dry Wells. Since these systems have significantly greater storage capacity than aggregate, space requirements are reduced and associated costs may be defrayed. Provided the following design guidelines are followed and infiltration is still encouraged, prefabricated chambers can prove just as effective as standard aggregate Dry Wells.



Applications

Any roof or impervious area with relatively low sediment loading

Design Considerations

1. Dry Wells are sized to temporarily retain and infiltrate stormwater runoff from roofs of structures. A dry well usually provides stormwater management for a limited roof area. Care should be taken not to hydraulically overload a dry well based on bottom area and drainage area. (See Appendix C, Protocol 2 for guidance)
2. Dry Wells should drain-down within the guidelines set in Chapter 3. Longer drain-down times reduce Dry Well efficiency and can lead to anaerobic conditions, odor and other problems.
3. Dry Wells typically consist of 18 to 48 inches of clean washed, uniformly graded aggregate with 40% void capacity (AASHTO No. 3, or similar). Dry Well aggregate is wrapped in a nonwoven geotextile, which provides separation between the aggregate and the surrounding soil. At least 12 inches of soil is then placed over the Dry Well. An alternative form of Dry Well is a subsurface, prefabricated chamber. A variety of prefabricated Dry Wells are currently available on the market.

4. Dry Wells are not recommended when their installation would create a significant risk for basement seepage or flooding. In general, 10 feet of separation is recommended between Dry Wells and building foundations. However, this distance may be shortened at the discretion of the designer. Shorter separation distances may warrant an impermeable liner to be installed on the building side of the Dry Well.
5. All Dry Wells should be able to convey system overflows to downstream drainage systems. System overflows can be incorporated either as surcharge (or overflow) pipes extending from roof leaders or via connections to more substantial infiltration areas.
6. The design depth of a Dry Well should take into account frost depth to prevent frost heave.
7. A removable filter with a screened bottom should be installed in the roof leader below the surcharge pipe in order to screen out leaves and other debris.
8. Adequate inspection and maintenance access to the Well should be provided. Observation wells not only provide the necessary access to the Well, but they also provide a conduit through which pumping of stored runoff can be accomplished in case of slowed infiltration.
9. Though roofs are generally not a significant source of runoff pollution, they can still be a source of particulates and organic matter, as well as sediment and debris during construction. Measures such as roof gutter guards, roof leader clean-out with sump, or an intermediate sump box can provide pretreatment for Dry Wells by minimizing the amount of sediment and other particulates that may enter it.

NOTE:

1. FABRICATE FROM 12 GA. STEEL SHEET, 12 GA. CORR. PIPE (STEEL OR ALUM.) OR 1/4" FIBERGLASS.
2. STEEL OPTIONS SHALL BE GALV. AFTER FABRICATION.
3. MIN. PERFORATIONS - 4 ROWS OF 3/4" HOLES, 8 HOLES PER ROW, ALL OPTIONS.

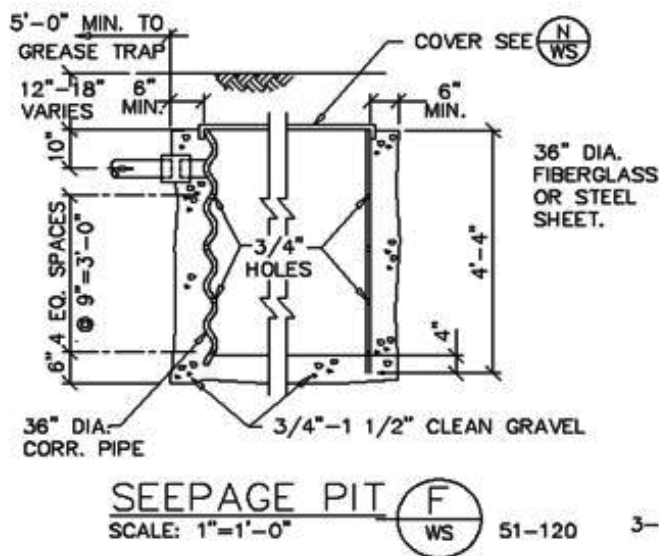

Detailed Stormwater Functions

Volume Reduction Calculations

The storage volume of a Dry Well is defined as the volume beneath the discharge invert. The following equation can be used to determine the approximate storage volume of an aggregate Dry Well:

Dry Well Volume = Dry well area (sf) x Dry well water depth (ft) x 40% (if stone filled)

Infiltration Area: A dry well may consider both bottom and side (lateral) infiltration according to design.

Peak Rate Mitigation Calculations

See Chapter 8 for corresponding peak rate reduction.

Water Quality Improvement

See Chapter 8

Construction Sequence

1. Protect infiltration area from compaction prior to installation.
2. If possible, install Dry Wells during later phases of site construction to prevent sedimentation and/or damage from construction activity.
3. Install and maintain proper Erosion and Sediment Control Measures during construction as per the Pennsylvania Erosion and Sediment Pollution Control Program Manual (March 2000, or latest edition).
4. Excavate Dry Well bottom to a uniform, level uncompacted subgrade free from rocks and debris. Do NOT compact subgrade. To the greatest extent possible, excavation should be performed with the lightest practical equipment. Excavation equipment should be placed outside the limits of the Dry Well.
5. Completely wrap Dry Well with nonwoven geotextile. (If sediment and/or debris have accumulated in Dry Well bottom, remove prior to geotextile placement.) Geotextile rolls should overlap by a minimum of 24 inches within the trench. Fold back and secure excess geotextile during stone placement.
6. Install continuously perforated pipe, observation wells, and all other Dry Well structures. Connect roof leaders to structures as indicated on plans.
7. Place uniformly graded, clean-washed aggregate in 6-inch lifts, lightly compacting between lifts.
8. Fold and secure nonwoven geotextile over trench, with minimum overlap of 12-inches.
9. Place 12-inch lift of approved Topsoil over trench, as indicated on plans.
10. Seed and stabilize topsoil.
11. Connect surcharge pipe to roof leader and position over splashboard.

12. Do not remove Erosion and Sediment Control measures until site is fully stabilized.

Maintenance Issues

As with all infiltration practices, Dry Wells require regular and effective maintenance to ensure prolonged functioning. The following represent minimum maintenance requirements for Dry Wells:

- Inspect Dry Wells at least four times a year, as well as after every storm exceeding 1 inch.
- Dispose of sediment, debris/trash, and any other waste material removed from a Dry Well at suitable disposal/recycling sites and in compliance with local, state, and federal waste regulations.
- Evaluate the drain-down time of the Dry Well to ensure the maximum time of 72 hours is not being exceeded. If drain-down times are exceeding the maximum, drain the Dry Well via pumping and clean out perforated piping, if included. If slow drainage persists, the system may need replacing.
- Regularly clean out gutters and ensure proper connections to facilitate the effectiveness of the dry well.
- Replace filter screen that intercepts roof runoff as necessary.
- If an intermediate sump box exists, clean it out at least once per year.

Cost Issues

The construction cost of a Dry Well/Seepage Pit can vary greatly depending on design variability, configuration, location, site-specific conditions, etc. Typical construction costs in 2003 dollars range from \$4 - \$9 per cubic foot of storage volume provided (SWRPC, 1991; Brown and Schueler, 1997). Annual maintenance costs have been reported to be approximately 5 to 10 percent of the capital costs (Schueler, 1987). The cost of gutters is typically included in the total structure cost, as opposed

Specifications

The following specifications are provided for information purposes only. These specifications include information on acceptable materials for typical applications, but are by no means exclusive or limiting. The designer is responsible for developing detailed specifications for individual design projects in accordance with the project conditions.

1. Stone for infiltration trenches shall be 2-inch to 1-inch uniformly graded coarse aggregate, with a wash loss of no more than 0.5%, AASHTO size No. 3 per AASHTO Specifications, Part I, 19th Ed., 1998, or later and shall have voids 40% as measured by ASTM-C29.

2. Nonwoven Geotextile shall consist of needled nonwoven polypropylene fibers and meet the following properties:

- a. Grab Tensile Strength (ASTM-D4632) ³ 120 lbs
- b. Mullen Burst Strength (ASTM-D3786) ³ 225 psi
- c. Flow Rate (ASTM-D4491) ³ 95 gal/min/ft²
- d. UV Resistance after 500 hrs (ASTM-D4355)³ 70%
- e. Heat-set or heat-calendared fabrics are not permitted
Acceptable types include Mirafi 140N, Amoco 4547, and Geotex 451.

3. Topsoil See Appendix C

4. Pipe shall be continuously perforated, smooth interior, with a minimum inside diameter of 4-inches. High-density polyethylene (HDPE) pipe shall meet AASHTO M252, Type S or AASHTO M294, Type S. 12 gauge aluminum or corrugated steel pipe may be used in seepage pits.

5. Gutters and splashboards shall follow Manufacturer's specifications.

References

New Jersey Department of Environmental Protection. *New Jersey Stormwater Best Management Practices Manual*. 2004.

New York Department of Environmental Conservation. *New York State Stormwater Management Design Manual*. 2003.

French Drains. <http://www.unexco.com/french.html>. 2004.

SWRPC, The Use of Best Management Practices(BMPs) in Urban Watersheds, US Environmental Protection Agency,1991.

Brown and Schueler, *Stormwater Management Fact Sheet: Infiltration Trench*. 1997.

Schueler, T., 1987. *Controlling urban runoff: a practical manual for planning and designing urban BMPs*, Metropolitan Washington Council of Governments, Washington, DC

BMP 6.4.7: Constructed Filter



Filters are structures or excavated areas containing a layer of sand, compost, organic material, peat, or other filter media that reduce pollutant levels in stormwater runoff by filtering sediments, metals, hydrocarbons, and other pollutants.

<p style="text-align: center;"><u>Key Design Elements</u></p> <ul style="list-style-type: none"> ▪ Follow Infiltration Systems Guidelines in Appendix C ▪ Drain down – should empty within the guidelines in Chapter 3 ▪ Minimum permeability of filtration medium required ▪ Minimum depth of filtering medium = 12" ▪ Perforated pipes in stone, as required ▪ May be designed to collect and convey filtered runoff down-gradient ▪ May be designed to infiltrate ▪ Pretreatment for debris and sediment may be needed ▪ Should be sized for drainage area ▪ Regular inspection and maintenance required for continued functioning ▪ Positive overflow is needed 	<p style="text-align: center;"><u>Potential Applications</u></p> <p>Residential: Limited Commercial: Yes Ultra Urban: Yes Industrial: Yes Retrofit: Yes Highway/Road: Yes</p> <hr/> <p style="text-align: center;"><u>Stormwater Functions</u></p> <p>Volume Reduction: Low-High* Recharge: Low-High* Peak Rate Control: Low-High* Water Quality: High</p> <p>* Depends on if infiltration is used</p> <hr/> <p style="text-align: center;"><u>Water Quality Functions</u></p> <p>TSS: 85% TP: 85% NO3: 30%</p>
---	--

Other Considerations

- **Protocol 1. Site Evaluation and Soil Infiltration Testing** and **Protocol 2. Infiltration Systems Guidelines** should be followed, see Appendix C
- Certain applications may warrant spill containment.

Description

A stormwater filter is a structure or excavation filled with material and designed to filter stormwater runoff to improve water quality. The filter media may be comprised of materials such as sand, peat, compost, granular activated carbon (GAC), perlite, or other material. Additional filtration media will be acceptable for use as long as data is available to verify the media is capable of meeting performance goals. In some applications the stormwater runoff flows through an open air, "pretreatment" chamber to allow the large particles and debris to settle out (sedimentation). Surface vegetation is another good option for pretreatment. The runoff then passes through the filter media where additional pollutants are filtered out, and is collected in an under-drain and returned to the conveyance system, receiving waters or infiltrated into the soil mantle.

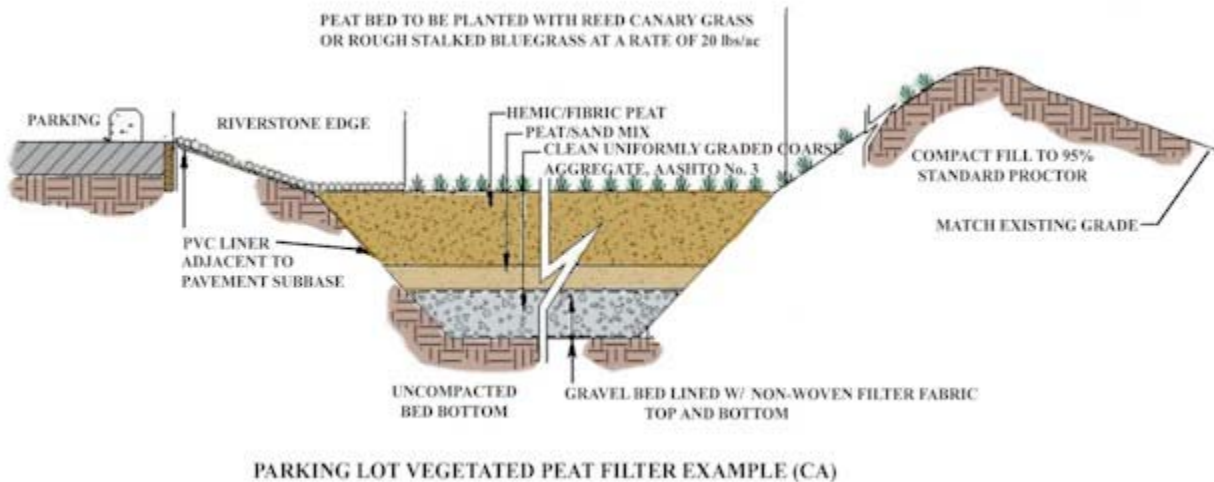

Variations

There are a wide variety of Filter Applications, including surface and subsurface, vegetated, perimeter, infiltration, and others. There are also a variety of filter products that may be purchased. Examples of these variations include:

Surface Non-vegetated Filter

A Surface Non-vegetated Filter is constructed by excavation or by use of a structural container. The surface may be covered in sand, peat, gravel, river stone, or similar material.



Vegetated Filter

A layer of vegetation is planted on top of the filtering medium. Composted amended soil may serve as a filter media. For filters composed of filtering media such as sand (where topsoil is required for vegetation) a layer of nonwoven, permeable geotextile should separate the topsoil and vegetation from the filter media.



Infiltration Filter

Filters may be designed to allow some portion of the treated water to infiltrate. Infiltration Design Criteria apply for all Filters designed with infiltration. In all cases, a positive overflow system is recommended.

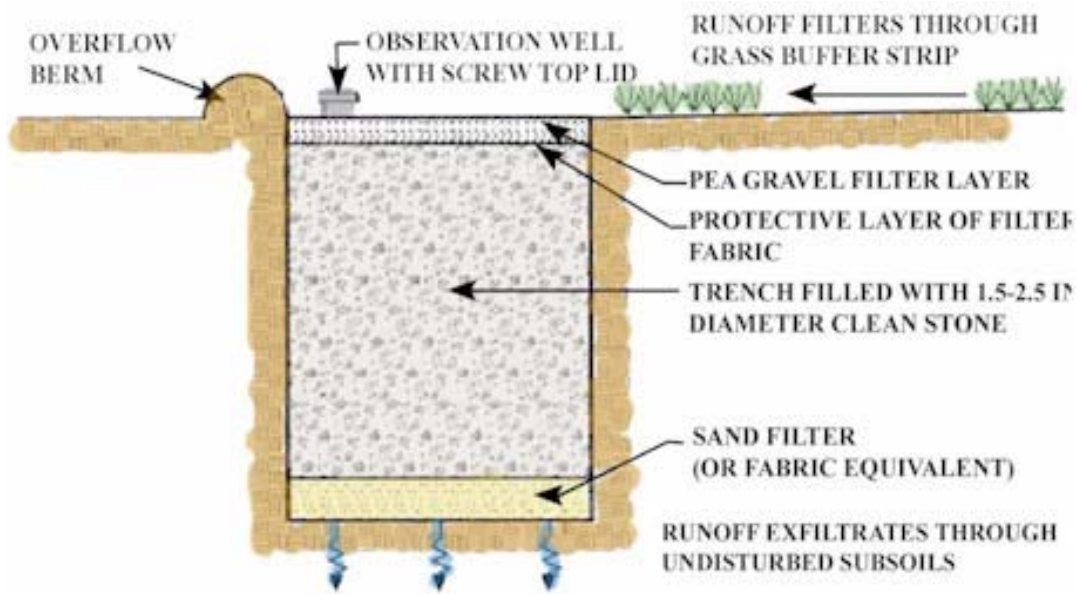

Contained Filter

In contained Filters, infiltration is not incorporated into the design. Contained Filters may consist of a physical structure, such as a precast concrete box. For excavated filters, an impermeable liner is added to the bottom of the excavation to convey the filtered runoff downstream.



Linear “Perimeter” Filters

Perimeter Filters may consist of enclosed chambers (such as trench drains) that run along the perimeter of an impervious surface. Perimeter Filters may also be constructed by excavation and vegetated. All perimeter filters should be designed with the necessary filter medium and sized in accordance with the drainage area.



Small Subsurface Filter

A Small Subsurface filter is an inlet designed to treat runoff at the collection source by filtration. Small Subsurface filters are useful for Hotspot Pretreatment and similar in function to Water Quality Inserts. Small Subsurface filters should be carefully designed and maintained so that runoff is directed through the filter media.

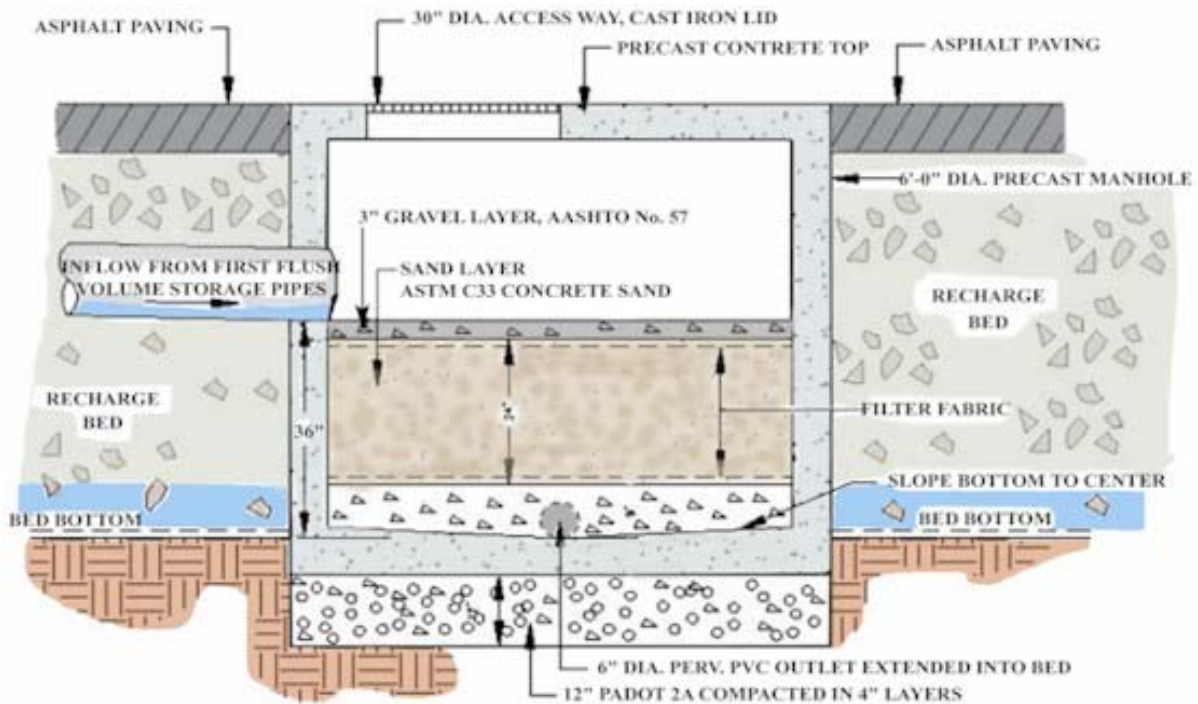

Large Subsurface Filter

Large Subsurface Filters receive relatively large amounts of flow directed into an underground box that has separate chambers, one to settle large particles, and one to filter small particles. The water discharges through an outlet pipe and into the stormwater system.

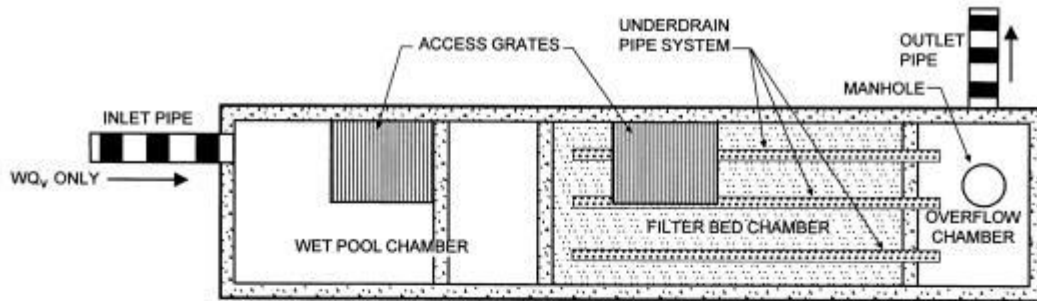

PLAN VIEW

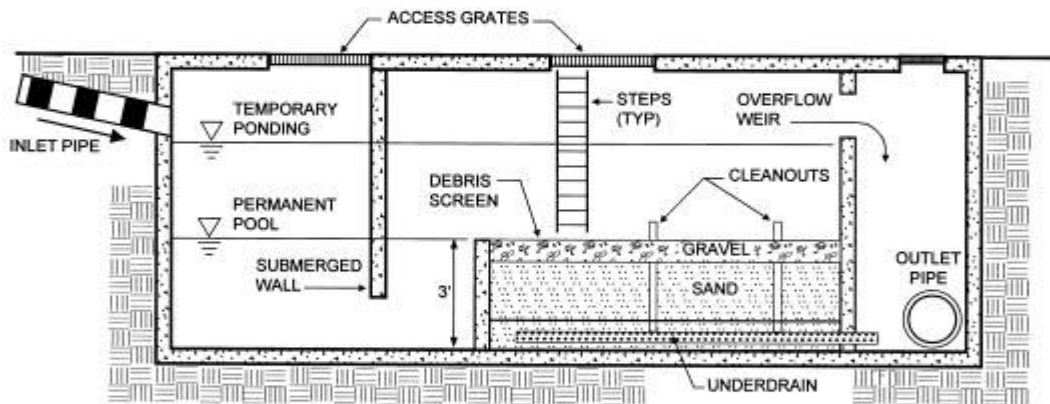

PROFILE

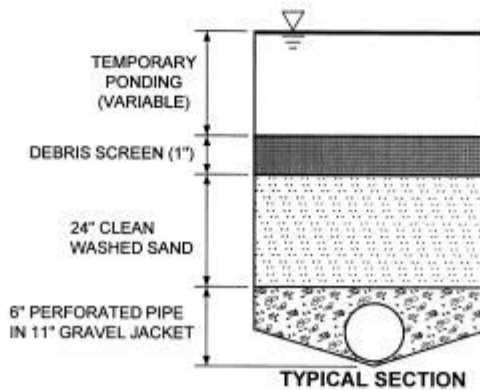

TYPICAL SECTION

Manufactured Filtration Systems

There are a considerable number of manufactured filtration systems available, some of which also incorporate oil/water separators, vortex systems, etc. The Designer should obtain product specific information directly from the manufacturer.

Applications

Filters are applicable in urbanized areas having high pollutant loads and are especially applicable where there is limited area for construction of other BMPs. Filters may be used as a pretreatment BMP before other BMPs such as Wet Ponds or Infiltration systems. Filters may be used in Hot Spot areas for water quality treatment, and spill containment capabilities may be incorporated into a filter. Examples of typical areas that benefit from the use of a Filter BMP include:

- Parking lots
- Roadways and Highways
- Light Industrial sites
- Marina areas
- Transportation facilities
- Fast food and shopping areas
- Waste Transfer Stations
- Urban Streetscapes

Design Considerations

1. Filters should be sized as per the Control Guideline that applies. All filters should be designed so that **larger storms may safely overflow or bypass the filter**. Flow splitters, multistage chambers, and other devices may be used. A flow splitter may be necessary to allow only a portion of the runoff to enter the filter. This would create an “off-line” filter, where the volume and velocity of runoff entering the filter is controlled. If the filter is “on-line”, excess flow should be designed to bypass the filter and continue to another quality BMP.
2. **Entering velocity should be controlled**. A level spreader may be used to spread flow evenly across the filter surface during all storms without eroding the filter material. Parking lots may be designed to sheet flow to filters. Small riprap or riverstone edges may be used to reduce velocity and distribute flow.
3. **Pretreatment** may be necessary in areas with especially high levels of debris, large sediment, etc. Pretreatment may include oil/grit separators, vegetated filter strips, or grass swales. These measures will settle out the large particles and reduce velocity of the runoff before it enters the filter.
4. The **Filter Media** may be a variety of materials and in most cases should have a minimum depth of 12 inches and a maximum depth of 30 inches, although variations on these guidelines are acceptable if justified by the designer. Coarser materials allow for more hydraulic conductivity, but finer media filter particles of a smaller size. Sand has been found to be a good balance between these two criteria, but different types of media remove different pollutants. While sand is a reliable material to remove TSS, (Debusk and Langston, 1997) peat removes slightly more

TP, Cu, Cd, and Ni than sand. The Filter Media should have a minimum hydraulic conductivity (k) as follows:

- Sand 3.5 ft/day
- Peat 2.5 ft/day
- Leaf compost 8.7 ft/day

5. A **Gravel Layer** at least 6” deep is recommended beneath the Filter Media.
6. **Under drain piping** should be 4” minimum (diameter) perforated pipes, with a lateral spacing of no more than 10’. A collector pipe can be used, (running perpendicular to laterals) with a slope of 1%. All underground pipes should have clean-outs accessible from the surface.
7. A **Drawdown Time** of not more than 72 hours is recommended for Filters.
8. The **Size** of a Filter is determined by the Volume to be treated:

$$A = V \times d / (k \times t(h+d))$$

- A = Surface area of Filter (square feet)**
- V = Water volume (cubic feet)**
- d = Depth of Filter Media (min 1.5 ft; max 2.5 ft)**
- t = Drawdown time (days), not to exceed 72 hours**
- h = Head (average in feet)**
- k = Hydraulic conductivity (ft/day)**

9. When a Filter has accumulated sediment in its pore space, its hydraulic conductivity is reduced, and so is its ability to removal pollutants. **Maintenance and Inspection** are essential for continued performance of a Filter. Based upon inspection, some or all portions of the filter media may require replacement.
10. Filters should be designed with **sufficient maintenance access** (clean-outs, room for surface cleaning, etc.). Filters that are visible and simple in design are more likely to be maintained correctly.

Detailed Stormwater Functions

Volume Reduction Calculations

If a Filter is designed to include infiltration, the Volume Reduction is a function of the Area of the Filter and infiltration rate. There is minimal volume reduction for Filters that are not designed to infiltrate.

Volume = Infiltration Volume* + Filter Volume

Infiltration Volume = Bottom Area (sf) x Infil. Rate (in/hr) x Drawdown time** (hr)

Filter Volume = Area of filter (sf) x Depth (ft) x 20%***

*For filters with infiltration only

** Not to exceed 72 hours

***For sand, amended soil, compost, peat; Use 20% unless more specific data is available

Peak Rate Mitigation Calculations

See Chapter 8 for Peak Rate Mitigation methodology which addresses link between volume reduction and peak rate control.

Water Quality Improvement

See Chapter 8 for Water Quality Improvement methodology, which addresses pollutant removal effectiveness of this BMP.

Construction Sequence

1. Permanent Filters should not be installed until the site is stabilized. Excessive sediment generated during construction can clog the Filter and prevent or reduce the anticipated post-construction water quality benefits. Stabilize all contributing areas before runoff enters filters.
2. Structures such as inlet boxes, reinforced concrete boxes, etc. should be installed in accordance with the manufacturers' or design engineers guidance.
3. Excavated filters that infiltrate or structural filters that infiltrate should be excavated in such a manner as to avoid compaction of the subbase. Structures may be set on a layer of clean, lightly compacted gravel (such as AASHTO #57).
4. Infiltration Filters should be underlain by a layer of permeable non-woven-geotextile.
5. Place underlying gravel/stone in minimum 6 inch lifts and lightly compact. Place underdrain pipes in gravel during placement.
6. Wrap and secure nonwoven geotextile to prevent gravel/stone from clogging with sediments.
7. Lay filtering material. Do not compact.
8. Saturate filter media and allow media to drain to properly settle and distribute.
9. For vegetated filters, a layer of nonwoven geotextile between non-organic filter media and planting media is recommended.
10. There should be sufficient space (head) between the top of the filtering bed and the overflow of the Filter to allow for the maximum head designed to be stored before filtration.



Maintenance and Inspection

Filters require a regular inspection and maintenance program in order to maintain the integrity of the filtering system and pollutant removal mechanisms. Studies have shown that filters are very effective upon installation, but quickly decrease in efficiency as sediment accumulates in the filter. (Urbonas, Urban Drainage and Flood Control District, CO) Odor is also a concern for filters that are not maintained. Inspection of the filter is recommended at least **four times a year**.

During inspection the following conditions should be considered:

- **Standing water** – any water left in a surface filter after the design drain down time indicates the filter is not optimally functioning.
- **Film or discoloration** of any surface filter material – this indicates organics or debris have clogged the filter surface.



Filter Maintenance

- Remove trash and debris as necessary
- Scrape silt with rakes
- Till and aerate filter area
- Replace filtering medium if scraping/removal has reduced depth of filtering media

In areas where the potential exists for the discharge and accumulation of toxic pollutants (such as metals), filter media removed from filters must be handled and disposed of in accordance with all state and federal regulations.

Winter concerns

Pennsylvania’s winter temperatures go below freezing about four months out of every year, and surface filtration may not take place as well in the winter. Peat and compost may hold water, freeze, and become impervious on the surface. Design options that allow directly for subsurface discharge into the filter media during cold weather may overcome this condition.

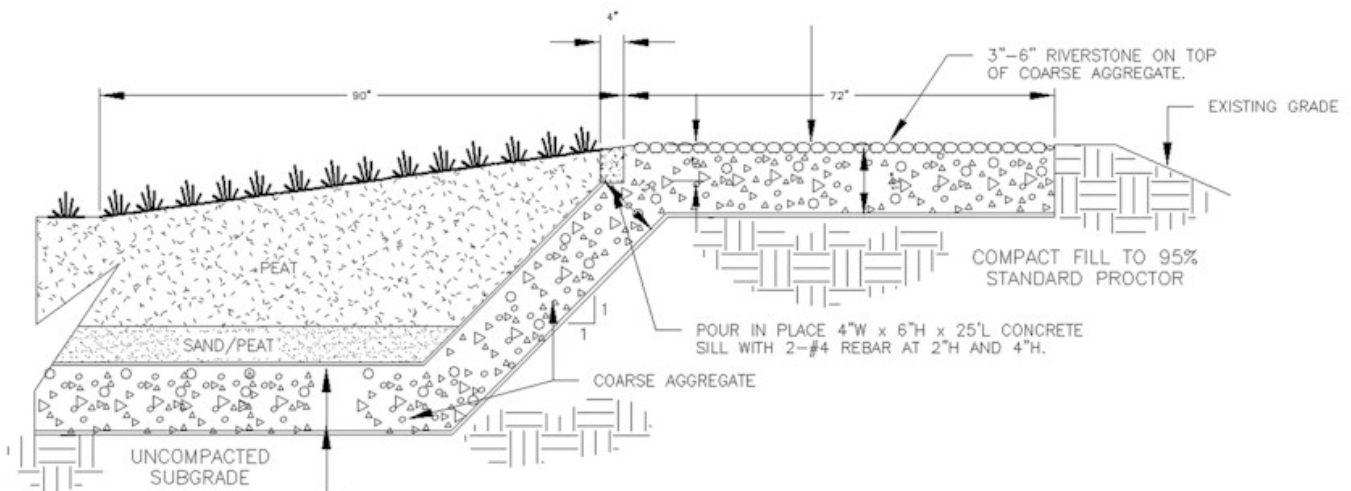

Cost Issues

Filter costs vary according to the filtering medial (sand, peat, compost), land clearing, excavation, grading, inlet and outlet structures, perforated pipes, encasing structure (if used), and maintenance cost. Underground structures may contribute significantly to the cost of a Filter.

Specifications

1. **Stone/Gravel** shall be uniformly graded coarse aggregate, 1 inch to ¾ inch with a wash loss of no more than 0.5%, AASHTO size number 57 per AASHTO Specifications, Part I, 19th Ed., 1998, or later and shall have voids 40% as measured by ASTM-C29.
2. **Peat** shall have ash content <15%, pH range 3.3-5.2, loose bulk density range 0.12-0.14 g/cc.
3. **Sand** shall be ASTM-C-33 (or AASHTO M-6) size (0.02" – 0.04"), concrete sand, clean, medium to fine sand, no organic material.
4. **Non-Woven Geotextile** shall consist of needled nonwoven polypropylene fibers and meet the following properties:
 - a. Grab Tensile Strength (ASTM-D4632) ³ 120 lbs
 - b. Mullen Burst Strength (ASTM-D3786) ³ 225 psi
 - c. Flow Rate (ASTM-D4491) ³ 95 gal/min/ft²
 - d. UV Resistance after 500 hrs (ASTM-D4355)³ 70%
 - e. Heat-set or heat-calendared fabrics are not permitted

Acceptable types include Mirafi 140N, Amoco 4547, Geotex 451, or approved others.

5. **Pipe** shall be continuously perforated, smooth interior, with a minimum inside diameter of 8-inches. High-density polyethylene (HDPE) pipe shall meet AASHTO M252, Type S or AASHTO M294, Type S.

References

Atlanta Regional Commission. *Georgia Stormwater Management Manual*. August 2001.

University of Minnesota Extension Service, Northeast Regional Correction Center (NERCC)

“Field Evaluation of a Stormwater Sand Filter” Ben R. Urbonas, John T. Doerfer and L. Scott Tucker
www.udfcd.org/fhn96/flood1.html

“An Evaluation of Filter Media For Treating Stormwater Runoff” Thomas A DeBustk and Michael A. Langston, Benefict Schwegler, Scott Davidson, Fifth Biennial Stormwater Research Conference, November, 1997

“A Denitrification System For Septic Tank Effluent Using Sphagnum Peat Moss” E. S. Winkler, and P. L. M. Veneman

“Stormwater Sand Filter Sizing and Design – A Unit Operations Approach” Urbonas

New York Department of Environmental Conservation. *New York Stormwater Management Manual*. 2003.

California Stormwater Quality Association. *California Stormwater BMP Handbook*. January 2003.

BMP 6.4.8: Vegetated Swale



A Vegetated Swale is a broad, shallow, trapezoidal or parabolic channel, densely planted with a variety of trees, shrubs, and/or grasses. It is designed to attenuate and in some cases infiltrate runoff volume from adjacent impervious surfaces, allowing some pollutants to settle out in the process. In steeper slope situations, check dams may be used to further enhance attenuation and infiltration opportunities.

<ul style="list-style-type: none"> ▪ Plant dense, low-growing native vegetation that is water-resistant, drought and salt tolerant, providing substantial pollutant removal capabilities ▪ Longitudinal slopes range from 1 to 6% ▪ Side slopes range from 3:1 to 5:1 ▪ Bottom width of 2 to 8 feet ▪ Check-dams can provide limited detention storage, as well as enhanced volume control through infiltration. Care must be taken to prevent erosion around the dam ▪ Convey the 10-year storm event with a minimum of 6 inches of freeboard ▪ Designed for non-erosive velocities up to the 10-year storm event ▪ Design to aesthetically fit into the landscape, where possible ▪ Significantly slow the rate of runoff conveyance compared to pipes 	<p style="text-align: center;"><u>Potential Applications</u></p> <p style="text-align: center;">Residential: Commercial: Yes Yes Ultra Urban: Limited Industrial: Yes Yes Retrofit: Yes Highway/Road:</p> <hr/> <p style="text-align: center;"><u>Stormwater Functions</u></p> <p style="text-align: center;">Volume Reduction: Low/Med. Recharge: Low/Med. Peak Rate Control: Med./High Water Quality: Med./High</p> <hr/> <p style="text-align: center;"><u>Water Quality Functions</u></p> <p style="text-align: center;">TSS: 50% TP: 50% NO3: 20%</p>
---	---

Other Considerations

- **Protocol 1. Site Evaluation and Soil Infiltration Testing** and **Protocol 2. Infiltration Systems Guidelines** should be followed whenever infiltration of runoff is desired, see Appendix C

Description

Vegetated swales are broad, shallow channels designed to slow runoff, promote infiltration, and filter pollutants and sediments in the process of conveying runoff. Vegetated Swales provide an environmentally superior alternative to conventional curb and gutter conveyance systems, while providing partially treated (pretreatment) and partially distributed stormwater flows to subsequent BMPs. Swales are often heavily vegetated with a dense and diverse selection of native, close-growing, water-resistant plants with high pollutant removal potential. The various pollutant removal mechanisms of a swale include: sedimentary filtering by the swale vegetation (both on side slopes and on bottom), filtering through a subsoil matrix, and/or infiltration into the underlying soils with the full array of infiltration-oriented pollutant removal mechanisms.

A Vegetated Swale typically consists of a band of dense vegetation, underlain by at least 24 inches of permeable soil. Swales constructed with an underlying 12 to 24 inch aggregate layer provide significant volume reduction and reduce the stormwater conveyance rate. The permeable soil media should have a minimum infiltration rate of 0.5 inches per hour and contain a high level of organic material to enhance pollutant removal. A nonwoven geotextile should completely wrap the aggregate trench (See BMP 6.4.4 Infiltration Trench for further design guidelines).

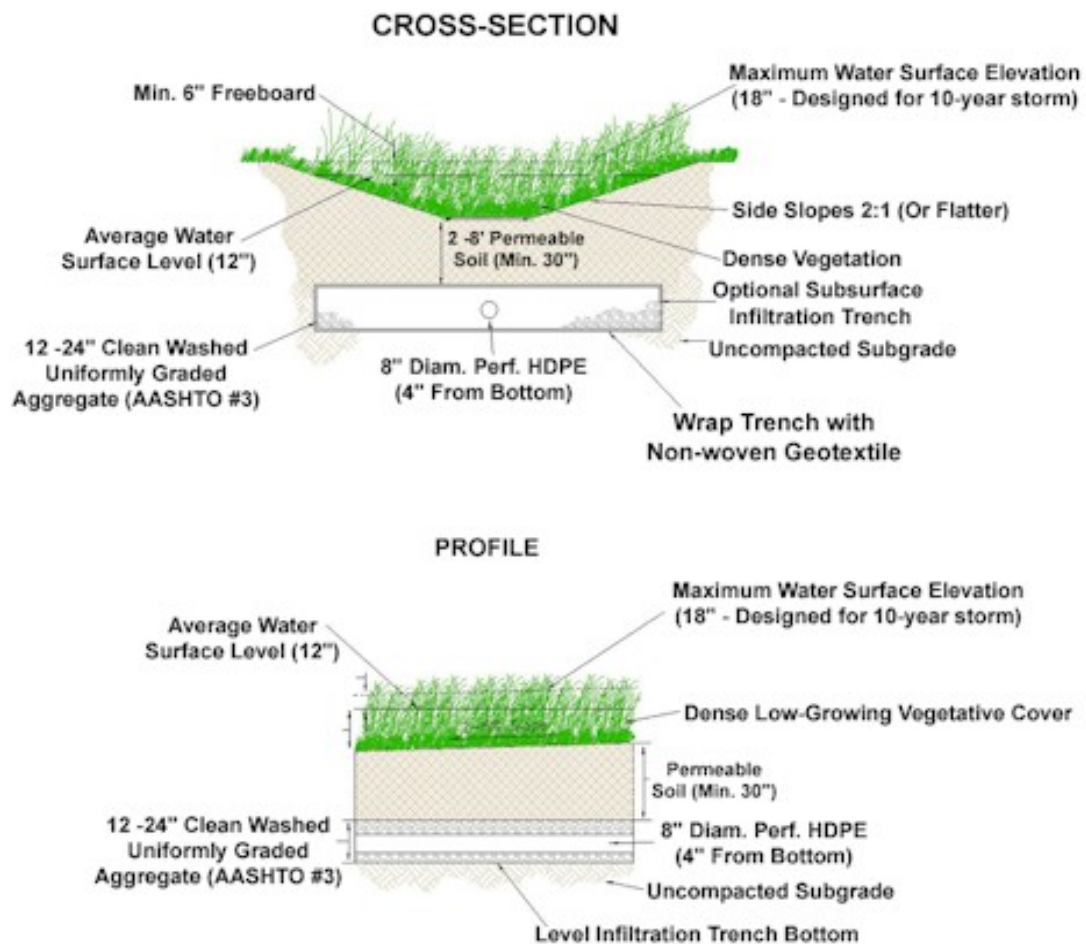

A major concern when designing Vegetated Swales is to make certain that excessive stormwater flows, slope, and other factors do not combine to produce erosive flows, which exceed the Vegetated Swale capabilities. Use of check dams or turf reinforcement matting (TRM) can enhance swale performance in some situations.

A key feature of vegetated swale design is that swales can be well integrated into the landscape character of the surrounding area. A vegetated swale can often enhance the aesthetic value of a site through the selection of appropriate native vegetation. Swales may also discreetly blend in with landscaping features, especially when adjacent to roads.



Variations

Vegetated Swale with Infiltration Trench

This option includes a 12 to 24 inch aggregate bed or trench, wrapped in a nonwoven geotextile (See BMP 6.4.4 Infiltration Trench for further design guidelines). This addition of an aggregate bed or trench substantially increases volume control and water quality performance although costs also are increased. Soil Testing and Infiltration Protocols in Appendix C should be followed.

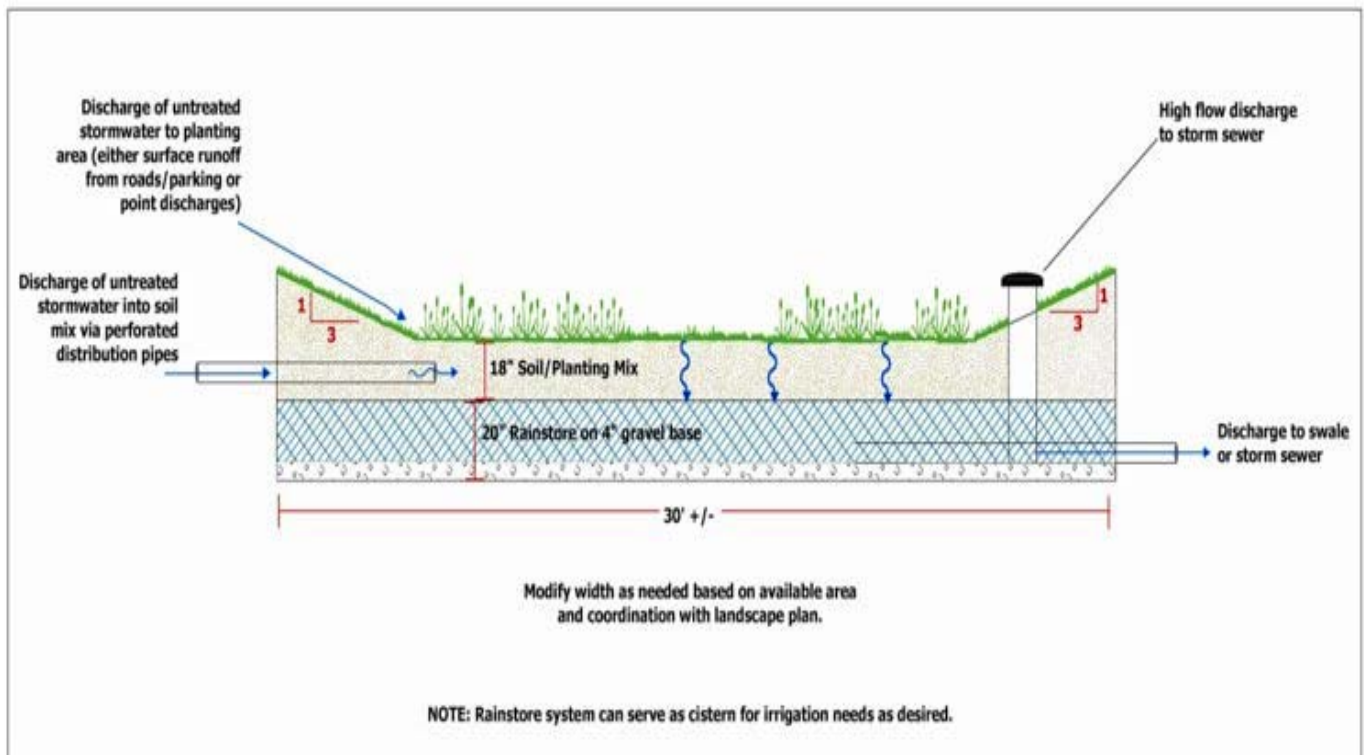

Vegetated Swales with Infiltration Trenches are best fitted for milder sloped swales where the addition of the aggregate bed system is recommended to make sure that the maximum allowable ponding time of 72 hours is not exceeded. This aggregate bed system should consist of at least 12 inches of

uniformly graded aggregate. Ideally, the underdrain system shall be designed like an infiltration trench. The subsurface trench should be comprised of terraced levels, though sloping trench bottoms may also be acceptable. The storage capacity of the infiltration trench may be added to the surface storage volume to achieve the required storage of the 1-inch storm event.

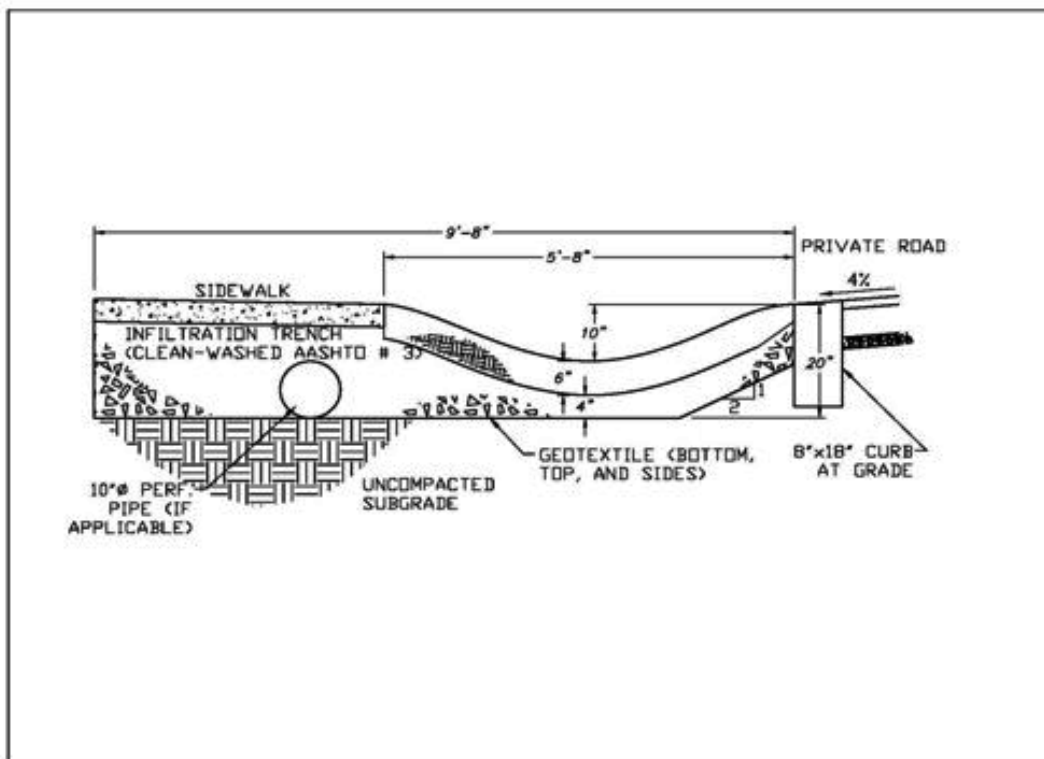

Grass Swale

Grass swales are essentially conventional drainage ditches. They typically have milder side and longitudinal slopes than their vegetated counterparts. Grass swales are usually less expensive than swales with longer and denser vegetation. However, they provide far less infiltration and pollutant removal opportunities. Grass swales are to be used only as pretreatment for other structural BMPs. Design of grass swales is often rate-based. Grassed swales, where appropriate, are preferred over catch basins and pipes because of their ability to reduce the rate of flow across a site.



Wet Swales

Wet swales are essentially linear wetland cells. Their design often incorporates shallow, permanent pools or marshy conditions that can sustain wetland vegetation, which in turn provides potentially high pollutant removal. A high water table or poorly drained soils are a prerequisite for wet swales. The drawback with wet swales, at least in



residential or commercial settings, is that they may promote mosquito breeding in the shallow standing water (follow additional guidance under Constructed Wetland for reducing mosquito population). Infiltration is minimal if water remains for extended periods.

Applications

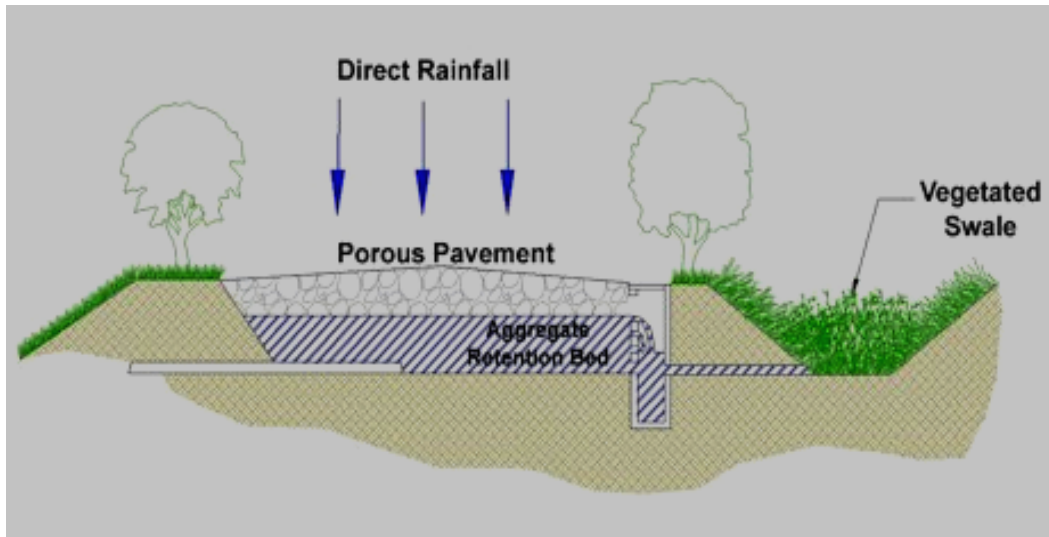

- **Parking**
- **Commercial and light industrial facilities**
- **Roads and highways**
- **Residential developments**
- **Pretreatment for volume-based BMPs**
- **Alternative to curb/gutter and storm sewer**

Design Considerations

1. Vegetated Swales are sized to temporarily store and infiltrate the 1-inch storm event, while providing conveyance for up to the 10-year storm with freeboard; flows for up to the 10-year storm are to be accommodated without causing erosion. Swales should maintain a maximum ponding depth of 18 inches at the end point of the channel, with a 12-inch average maintained throughout. Six inches of freeboard is recommended for the 10-year storm. Residence times between 5 and 9 minutes are acceptable for swales without check-dams. The maximum ponding time is 48 hours, though 24 hours is more desirable (minimum of 30 minutes). Studies have shown that the maximum amount of swale filtering occurs for water depths below 6 inches. It is critical that swale vegetation not be submerged, as it could cause the vegetation to bend over with the flow. This would naturally lead to reduced roughness of the swale, higher flow velocities, and reduced contact filtering opportunities.

2. Longitudinal slopes between 1% and 3% are generally recommended for swales. If the topography necessitates steeper slopes, check dams or TRM's are options to reduce the energy gradient and erosion potential.
3. Check dams are recommended for vegetated swales with longitudinal slopes greater than 3%. They are often employed to enhance infiltration capacity, decrease runoff volume, rate, and velocity, and promote additional filtering and settling of nutrients and other pollutants. In effect, check-dams create a series of small, temporary pools along the length of the swale, which shall drain down within a maximum of 72 hours. Swales with check-dams are much more effective at mitigating runoff quantity and quality than those without. The frequency and design of check-dams in a swale will depend on the swale length and slope, as well as the desired amount of storage/treatment volume. Care must be taken to avoid erosion around the ends of the check dams.



Check-dams shall be constructed to a height of 6 to 12 in and be regularly spaced. The following materials have been employed for check-dams: natural wood, concrete, stone, and earth. Earthen check-dams however, are typically not recommended due to their potential to erode. A weep hole(s) may be added to a check-dam to allow the retained volume to slowly drain out. Care should be taken to ensure that the weep hole(s) is not subject to clogging. In the case of a stone check-dam, a better approach might be to allow low flows (2-year storm) to drain through the stone, while allowing higher flows (10-year storm) drain through a weir in the center of the dam. Flows through a stone check-dam are a function of stone size, flow depth, flow width, and flow path length through the dam. The following equation can be used to estimate the flow through a stone check dam up to 6 feet long:

$$q = h^{1.5} / (L/D + 2.5 + L^2)^{0.5}$$

where:

- q = flow rate exiting check dam (cfs/ft)
- h = flow depth (ft)
- L = length of flow (ft)
- D = average stone diameter (ft) (more uniform gradations are preferred)

For low flows, check-dam geometry and swale width are actually more influential on flow than stone size. The average flow length through a check-dam as a function of flow depth can be determined by the following equation:

$$L = (ss) \times (2d - h)$$

where:

ss = check dam side slope (maximum 2:1)

d = height of dam (ft)

h = flow depth (ft)

When swale flows overwhelm the flow-through capacity of a stone check-dam, the top of the dam shall act as a standard weir (use standard weir equation). (Though a principal spillway, 6 inches below the height of the dam, may also be required depending on flow conditions.) If the check-dam is designed to be overtopped, appropriate selection of aggregate will ensure stability during flooding events. In general, one stone size for a dam is recommended for ease of construction. However, two or more stone sizes may be used, provided a larger stone (e.g. R-4) is placed on the downstream side, since flows are concentrated at the exit channel of the weir. Several feet of smaller stone (e.g. AASHTO #57) can then be placed on the upstream side. Smaller stone may also be more appropriate at the base of the dam for constructability purposes.

4. The effectiveness of a vegetated swale is directly related to the contributing land use, the size of the drainage area, the soil type, slope, drainage area imperviousness, proposed vegetation, and the swale dimensions. Use of natural low points in the topography may be suited for swale location, as are natural drainage courses although infiltration capability may also be reduced in these situations. The topography of a site should allow for the design of a swale with sufficiently mild slope and flow capacity. Swales are impractical in areas of extreme (very flat or steep) slopes. Of course, adequate space is needed for vegetated swales. Swales are ideal as an alternative to curbs and gutters along parking lots and along small roads in gently sloping terrain.

Siting of vegetated swales should take into account the location and function of other site features (buffers, undisturbed natural areas, etc.). Siting should also attempt to aesthetically fit the swale into the landscape as much as possible. Sharp bends in swales should be avoided.

Implementing vegetated swales is challenging when development density exceeds four dwelling units per acre, in which case the number of driveway culverts often increases to the point where swales essentially become broken-pipe systems.

Where possible, construct swales in areas of uncompacted cut. Avoid constructing side slopes in fill material. Fill slopes can be prone to erosion and/or structural damage by burrowing animals.

5. Soil Testing is required when infiltration is planned (see Appendix C).
6. Guidelines for Infiltration Systems should be met as necessary (see Appendix C).
7. Swales are typically most effective, when treating an area of 1 to 2 acres although vegetated swales can be used to treat and convey runoff from an area of 5 to 10 acres in size. Swales serving greater than 10-acre drainage areas will provide a lesser degree water quality treatment, unless special provisions are made to manage the increased flows.
8. Runoff can be directed into Vegetated Swales either as concentrated flows or as lateral sheet flow drainage. Both are acceptable provided sufficient stabilization or energy dissipation is

included (see #6). If flow is to be directed into a swale via curb cuts, provide a 2 to 3 inch drop at the interface of pavement and swale. Curb cuts should be at least 12 inches wide to prevent clogging and should be spaced appropriately.

9. Vegetated swales are sometimes used as pretreatment devices for other structural BMPs, especially roadway runoff. However, when swales themselves are intended to effectively treat runoff from highly impervious surfaces, pretreatment measures are recommended to enhance swale performance. Pretreatment can dramatically extend the functional life of any BMP, as well as increase its pollutant removal efficiency by settling out some of the heavier sediments. This treatment volume is typically obtained by installing check dams at pipe inlets and/or driveway crossings. Pretreatment options include a vegetated filter strip, a sediment forebay (or plunge pool) for concentrated flows, or a pea gravel diaphragm (or alternative) with a 6-inch drop where parking lot sheet flow is directed into a swale.
10. The soil base for a vegetated swale must provide stability and adequate support for proposed vegetation. When the existing site soil is deemed unsuitable (clayey, rocky, coarse sands, etc.) to support dense vegetation, replacing with approximately 12 inches of loamy or sandy soils is recommended. In general, alkaline soils should be used to further reduce and retain metals. Swale soils should also be well-drained. If the infiltration capacity is compromised during construction, the first several feet should be removed and replaced with a blend of topsoil and sand to promote infiltration and biological growth.
11. Swales are most efficient when their cross-sections are parabolic or trapezoidal in nature. Swale side slopes are best within a range of 3:1 to 5:1 and should not be greater than 2:1 for ease of maintenance and side inflow from sheet flow.
12. To ensure the filtration capacity and proper performance of swales, the bottom widths typically range from 2 to 8 feet. Wider channels are feasible only when obstructions such as berms or walls are employed to prohibit braiding or uncontrolled sub-channel formation. The maximum bottom width to depth ratio for a trapezoidal swale should be 12:1.
13. Ideal swale vegetation should consist of a dense and diverse selection of close-growing, water-resistant plants whose growing season preferably corresponds to the wet season. For swales that are not part of a regularly irrigated landscaped area, drought tolerant vegetation should be considered as well. Vegetation should be selected at an early stage in the design process, with well-defined pollution control goals in mind. Selected vegetation must be able to thrive at the specific site and therefore should be chosen carefully (See Appendix B). Use of native plant species is strongly advised, as is avoidance of invasive plant species. Swale vegetation must also be salt tolerant, if winter road maintenance activities are expected to contribute salt/chlorides.

Table 6.8.1

Commonly used vegetation in swale (New Jersey BMP Manual, 2004)		
Common Name	Scientific Name	Notes
Alkali Saltgrass	<i>Puccinellia distans</i>	Cool, good for wet, saline swales
Fowl Bluegrass	<i>Poa palustris</i>	Cool, good for wet swales
Canada Bluejoint	<i>Calamagrostis canadensis</i>	Cool, good for wet swales
Creeping Bentgrass	<i>Agrostis palustris</i>	Cool, good for wet swales, salt tolerant
Red Fescue	<i>Festuca rubra</i>	Cool, not for wet swales
Redtop	<i>Agrostis gigantea</i>	Cool, good for wet swales
Rough Bluegrass	<i>Poa trivialis</i>	Cool, good for wet, shady swales
Switchgrass	<i>Panicum virgatum</i>	Warm, good for wet swales, some salt tolerance
Wildrye	<i>Elymus virginicus/rigarius</i>	Cool, good for wet, shady swales

Notes: These grasses are sod forming and can withstand frequent inundation, and are ideal for the swale or grass channel environment. A few are also salt tolerant. Cool refers to cool season grasses that grow during the colder temperatures of spring and fall. Warm refers to warm season grasses that grow most vigorously during the hot, mid summer months.

By landscaping with trees along side slopes, swales can be easily and aesthetically integrated into the overall site design without unnecessary loss of usable space. An important consideration however, is that tree plantings allow enough light to pass and sustain a dense ground cover. When the trees have reached maturity, they should provide enough shade to markedly reduce high temperatures in swale runoff.

14. Check the temporary and permanent stability of the swale using the standards outlined in the Pennsylvania Erosion and Sediment Pollution Control Program Manual. Swales should convey either 2.75 cfs/acre or the calculated peak discharge from a 10-year storm event. The permissible velocity design method may be used for design of channel linings for bed slopes <0.10 ft/ft; use of the maximum permissible shear stress is acceptable for all bed slopes. Flow capacity, velocity, and design depth in swales are generally calculated by Manning’s equation.

Prior to establishment of vegetation, a swale is particularly vulnerable to scour and erosion and therefore its seed bed must be protected with temporary erosion control, such as straw matting, compost blankets, or curled wood blankets. Most vendors will provide information about the Manning’s ‘n’ value and will specify the maximum permissible velocity or allowable shear stress for the lining material.

The post-vegetation establishment capacity of the swale should also be confirmed. Permanent turf reinforcement may supersede temporary reinforcement on sites where not exceeding the maximum permissible velocity is problematic. If driveways or roads cross a swale, culvert capacity may supersede Manning’s equation for determination of design flow depth. In these cases, the culvert should be checked to establish that the backwater elevation would not exceed the banks of the swale. If the culverts are to discharge to a minimum tailwater condition, the exit velocity for the culvert should be evaluated for design conditions. If the maximum permissible velocity is exceeded at the culvert outlet, energy dissipation measures should be implemented. The following tables list the maximum permissible shear stresses (for various channel liners) and velocities (for channels lined with vegetation) from the Pennsylvania Erosion and Sediment Pollution Control Program Manual.

Maximum Permissible Shear Stresses for Various Channel Liners

Lining Category	Lining Type	lb/ft ²
Unlined - Erodible Soils*	Silts, Fine - Medium Sands	0.03
	Coarse Sands	0.04
	Very Coarse Sands	0.05
	Fine Gravel	0.10
Erosion Resistant Soils**	Clay loam	0.25
	Silty Clay loam	0.18
	Sandy Clay Loam	0.10
	Loam	0.07
	Silt Loam	0.12
	Sandy Loam	0.02
	Gravelly, Stony, Channery Loam	0.05
	Stony or Channery Silt Loam	0.07
Temporary Liners	Jute	0.45
	Straw with Net	1.45
	Coir - Double Net	2.25
	Coconut Fiber - Double Net	2.25
	Curled Wood Mat	1.55
	Curled Wood - Double Net	1.75
	Curled Wood - Hi Velocity	2.00
	Synthetic Mat	2.00
Vegetative Liners	Class B	2.10
	Class C	1.00
	Class D	0.60
Riprap***	R-1	0.25
	R-2	0.50
	R-3	1.00
	R-4	2.00
	R-5	3.00
	R-6	4.00
	R-7	5.00
	R-8	8.00

- * Soils having an erodibility "K" factor greater than 0.37
- ** Soils having an erodibility "K" factor less than or equal to 0.37
- *** Permissible shear stresses based on rock at 165 lb/cuft. Adjust velocities for other rock weights used. See Table 12.

Manufacturer's shear stress values based on independent tests may be used.

xture	<5	5	4
Reed Canarygrass	5-10	4	3
Serecea Lespedeza	<5	3.5	2.5
Weeping Lovegrass			
Redtop			
Red Fescue			
Annuals	<5	3.5	2.5
Temporary cover only			
Sudangrass			

¹ Cohesive (clayey) fine grain soils and coarse grain soils with a plasticity index OF 10 TO 40 (CL, CH, SC and GC). Soils with K values less than 0.37.

² Soils with K values greater than 0.37.

³ Use velocities exceeding 5 ft/sec only where good cover and proper maintenance can be obtained.

15. Manning's roughness coefficient, or 'n' value, varies with type of vegetative cover and design flow depth. Two common methods are based on design depth (see adjacent graph) and based on vegetative cover (as defined in the Pennsylvania Erosion and Sediment Pollution Control Program Manual). Either of these can be used in design.

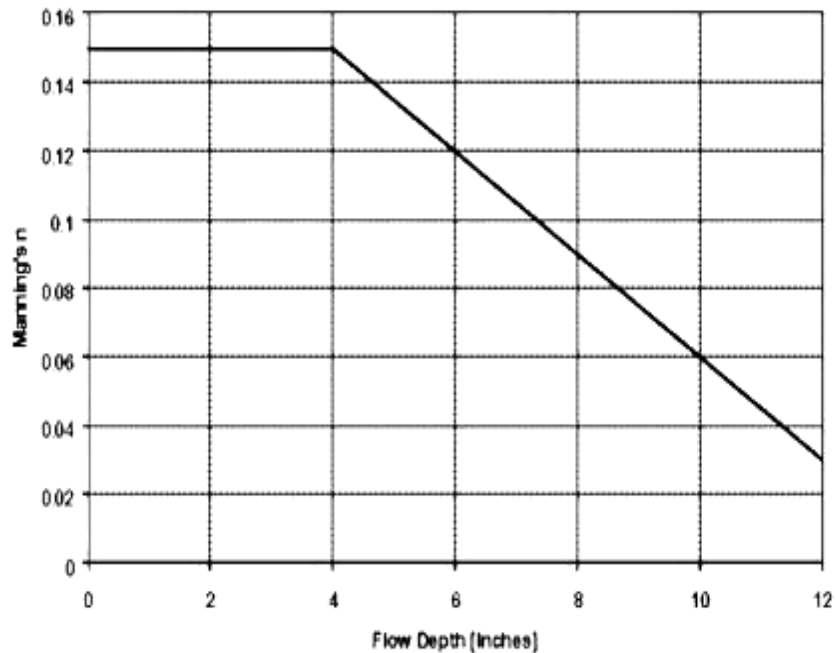

Figure D9.1 Manning's n Value with Varying Flow Depth (Source: Claytor and Schueler, 1986)

- 16. If swales are designed according to the guidelines discussed in this section, significant levels of pollutant reduction can be expected through filtration and infiltration. In a particular swale reach, runoff should be well filtered by the time it flows over a check-dam. Thus, the stabilizing stone apron on the downhill side of the check-dam may be designed as an extension of an infiltration trench. In this way, only filtered runoff will enter a subsurface infiltration trench, thereby reducing the threat of groundwater contamination by metals.
- 17. Culverts are typically used in a vegetated swale at driveway or road crossings. By oversizing culverts and their flow capacity, cold weather concerns (e.g. clogging with snow) are lessened.
- 18. Where grades limit swale slope and culvert size, trench drains may be used to cross driveways.
- 19. Swales should discharge to another structural BMP (bioretention, infiltration basin, constructed wetlands, etc.), existing stormwater infrastructure, or a stable outfall.

Detailed Stormwater Functions

Infiltration Area (if needed)

Volume Reduction Calculations

The volume retained behind each check-dam can be approximated from the following equation:

$$\text{Storage Volume} = 0.5 \times \text{Length of Swale Impoundment Area Per Check Dam} \times \text{Depth of Check Dam} \times (\text{Top Width of Check Dam} + \text{Bottom Width of Check Dam}) / 2$$

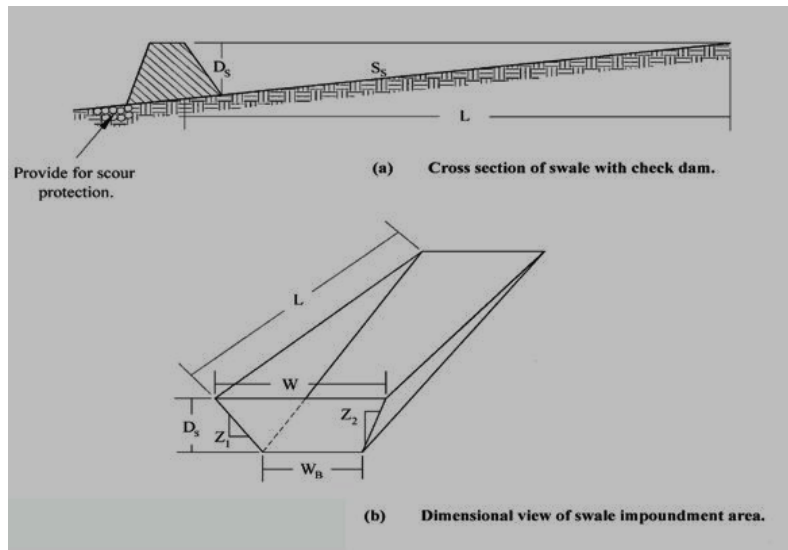

Peak Rate Mitigation

See Chapter 8 for Peak Rate Mitigation methodology, which addresses link between volume reduction and peak rate control.

Water Quality Improvement

See Chapter 8 for Water Quality Improvement methodology, which addresses pollutant removal effectiveness of this BMP.

Construction Sequence

1. Begin vegetated swale construction only when the upgradient temporary erosion and sediment control measures are in place. Vegetated swales should be constructed and stabilized early in the construction schedule, preferably before mass earthwork and paving increase the rate and volume of runoff. (Erosion and sediment control methods shall adhere to the Pennsylvania Department of Environmental Protection’s *Erosion and Sediment Pollution Control Program Manual*, March 2000 or latest edition.)
2. Rough grade the vegetated swale. Equipment shall avoid excessive compaction and/or land disturbance. Excavating equipment should operate from the side of the swale and never on the bottom. If excavation leads to substantial compaction of the subgrade (where an infiltration trench is not proposed), 18 inches shall be removed and replaced with a blend of topsoil and sand to promote infiltration and biological growth. At the very least, topsoil shall be thoroughly deep plowed into the subgrade in order to penetrate the compacted zone and promote aeration and the formation of macropores. Following this, the area should be disked prior to final grading of topsoil.
3. Construct check dams, if required.
4. Fine grade the vegetated swale. Accurate grading is crucial for swales. Even the smallest non-conformities may compromise flow conditions.

5. Seed, vegetate and install protective lining as per approved plans and according to final planting list. Plant the swale at a time of the year when successful establishment without irrigation is most likely. However, temporary irrigation may be needed in periods of little rain or drought. Vegetation should be established as soon as possible to prevent erosion and scour.
6. Once all tributary areas are sufficiently stabilized, remove temporary erosion and sediment controls. It is very important that the swale be stabilized before receiving upland stormwater flow.
7. Follow maintenance guidelines, as discussed below.

Note: If a vegetated swale is used for runoff conveyance during construction, it should be regraded and reseeded immediately after construction and stabilization has occurred. Any damaged areas should be fully restored to ensure future functionality of the swale.

Maintenance Issues

Compared to other stormwater management measures, the required upkeep of vegetated swales is relatively low. In general, maintenance strategies for swales focus on sustaining the hydraulic and pollutant removal efficiency of the channel, as well as maintaining a dense vegetative cover. Experience has proven that proper maintenance activities ensure the functionality of vegetated swales for many years. The following schedule of inspection and maintenance activities is recommended:

Maintenance activities to be done annually and within 48 hours after every major storm event (> 1 inch rainfall depth):

- Inspect and correct erosion problems, damage to vegetation, and sediment and debris accumulation (address when > 3 inches at any spot or covering vegetation)
- Inspect vegetation on side slopes for erosion and formation of rills or gullies, correct as needed
- Inspect for pools of standing water; dewater and discharge to an approved location and restore to design grade
- Mow and trim vegetation to ensure safety, aesthetics, proper swale operation, or to suppress weeds and invasive vegetation; dispose of cuttings in a local composting facility; mow only when swale is dry to avoid rutting
- Inspect for litter; remove prior to mowing
- Inspect for uniformity in cross-section and longitudinal slope, correct as needed
- Inspect swale inlet (curb cuts, pipes, etc.) and outlet for signs of erosion or blockage, correct as needed

Maintenance activities to be done as needed:

- Plant alternative grass species in the event of unsuccessful establishment

- Reseed bare areas; install appropriate erosion control measures when native soil is exposed or erosion channels are forming
- Rototill and replant swale if draw down time is more than 48 hours
- Inspect and correct check dams when signs of altered water flow (channelization, obstructions, erosion, etc.) are identified
- Water during dry periods, fertilize, and apply pesticide **only when absolutely necessary**

Most of the above maintenance activities are reasonably within the ability of individual homeowners. More intensive swales (i.e. more substantial vegetation, check dams, etc.) may warrant more intensive maintenance duties and should be vested with a responsible agency. A legally binding and enforceable maintenance agreement between the facility owner and the local review authority might be warranted to ensure sustained maintenance execution. Winter conditions also necessitate additional maintenance concerns, which include the following:

- Inspect swale immediately after the spring melt, remove residuals (e.g. sand) and replace damaged vegetation without disturbing remaining vegetation.
- If roadside or parking lot runoff is directed to the swale, mulching and/or soil aeration/manipulation may be required in the spring to restore soil structure and moisture capacity and to reduce the impacts of deicing agents.
- Use nontoxic, organic deicing agents, applied either as blended, magnesium chloride-based liquid products or as pretreated salt.
- Use salt-tolerant vegetation in swales.

Cost Issues

As with all other BMPs, the cost of installing and maintaining Vegetated Swales varies widely with design variability, local labor/material rates, real estate value, and contingencies. In general, Vegetated Swales are considered relatively low cost control measures. Moreover, experience has shown that Vegetated Swales provide a cost-effective alternative to traditional curbs and gutters, including associated underground storm sewers. The following table compares the cost of a typical vegetated swale (15 ft top width) with the cost of traditional conveyance elements.

ot)			
Total Annual Cost (per linear foot)	\$1 (from seed) (from sod)	\$2	No data
Lifetime (years)	50		20

It is important to note that the costs listed above are strictly estimates and shall be used for design purposes only. Also, these costs do not include the cost of activities such as clearing, grubbing, leveling, filling, and sodding (if required). The Southeastern Wisconsin Regional Planning Commission (SEWRPC, 1991) reported that actual costs, which do include these activities, may range from \$8.50 to \$50.00 per linear foot depending on swale depth and bottom width. When all pertinent construction activities are considered, it is still likely that the cost of vegetated swale installation is less than that of traditional conveyance elements. When annual operation and maintenance costs are considered however, swales may prove the more expensive option, though they typically have a much longer lifespan.

Specifications

The following specifications are provided for information purposes only. These specifications include information on acceptable materials for typical applications, but are by no means exclusive or limiting. The designer is responsible for developing detailed specifications for individual design projects in accordance with the project conditions.

1. **Swale Soil** shall be USCS class ML (Inorganic silts and very fine sands, rock flour, silty or clayey fine sands with slight plasticity), SM (Silty sands, poorly graded sand-silt mixtures), SW (Well-graded sands, gravelly sands, little or no fines) or SC (Clayey sands, poorly graded sand-clay mixtures). The first three of these designations are preferred for swales in cold climates. In general, soil with a higher percent organic content is preferred.
2. **Swale Sand** shall be ASTM C-33 fine aggregate concrete sand (0.02 in to 0.04 in).
3. **Check dams** constructed of natural wood shall be 6 in to 12 in diameter and notched as necessary. The following species are acceptable: Black Locust, Red Mulberry, Cedars, Catalpa, White Oak, Chestnut Oak, Black Walnut. The following species are not acceptable, as they can rot over time: Ash, Beech, Birch, Elm, Hackberry, hemlock, Hickories, Maples, Red and Black Oak, Pines, Poplar, Spruce, Sweetgum, and Willow. An earthen **check dam** shall be constructed of sand, gravel, and sandy loam to encourage grass cover (Sand: ASTM C-33 fine aggregate concrete sand 0.02 in to 0.04 in, Gravel: AASHTO M-43 0.5 in to 1.0 in). A stone **check dam** shall be constructed of R-4 rip rap, or equivalent.
4. Develop a native **planting mix**. (see Appendix B)
5. If infiltration trench is proposed, see BMP 6.4.4 Infiltration Trench for specifications.

References

Alameda Countywide Clean Water Program (ACCWP). "Grassy Swales." *Catalog of Control Measures*. <http://www.oaklandpw.com/creeks/pdf/Grassy_Swales.pdf>

AMEC Earth and Environmental Center for Watershed Protection et al. *Georgia Stormwater Management Manual*. 2001.

California Stormwater Quality Association. *California Stormwater Best Management Practices Handbook: New Development and Redevelopment*. 2003.

Caraco and Claytor. *Stormwater BMP Design Supplement for Cold Climates*. 1997.

- City of Portland Environmental Services. *City of Portland Stormwater Management Manual: Revision #2*. 2002.
- Center for Watershed Protection and Maryland Department of the Environment. *2000 Maryland Stormwater Design Manual*. Baltimore, MD: 2000.
- Claytor, R.A. and T.R. Schuler. *Design of Stormwater Filtering Systems*. Center for Watershed Protection. Silver Spring, MD: 1996.
- Colwell, S. R. et al. *Characterization of Performance Predictors and Evaluation of Mowing Practices in Biofiltration Swales*. 2000.
- Fletcher, T., Wong, T., and Breen, P. "Chapter 8 – Buffer Strips, Vegetated Swales and Bioretention Systems." *Australian Runoff Quality (Draft)*. University of New Castle – Australia.
- Lichten, K. "Grassy Swales." BMP Fact Sheets. Bay Area Stormwater Management Agencies Association (BASMAA). 1997.
- Maine Department of Transportation. *Maine Department of Transportation BMP Manual for Erosion and Sedimentation Control*. 1992.
- North Central Texas Council of Governments. *Stormwater Best Management Practices: A Menu of Management Plan Options for Small MS4s in North Central Texas*. 2002.
- Schueler, T. et al. *A Current Assessment of Urban Best Management Practices: Techniques for Reducing Nonpoint Source Pollution in the Coastal Zone*. 1992.
- United States Environmental Protection Agency (USEPA). "Post-Construction Storm Water Management in New Development & Redevelopment." *National Pollutant Discharge Elimination System (NPDES)*. <http://cfpub1.epa.gov/npdes/stormwater/menuofbmps/post_8.cfm>
- United States Environmental Protection Agency (USEPA). *Storm Water Technology Fact Sheet: Vegetated Swales* (EPA 832-F-99-006). 1999.
- Vermont Agency of Natural Resources. *The Vermont Stormwater Management Manual*. 2002.
- Virginia Stormwater Management Handbook, Volumes 1 and 2, First Edition, 1999

BMP 6.4.9: Vegetated Filter Strip

The EPA defines a Vegetated Filter Strip as a “permanent, maintained strip of planted or indigenous vegetation located between nonpoint sources of pollution and receiving water bodies for the purpose of removing or mitigating the effects of nonpoint source pollutants such as nutrients, pesticides, sediments, and suspended solids.”

<p style="text-align: center;"><u>Key Design Elements</u></p> <ul style="list-style-type: none"> ▪ Sheet Flow across Vegetated Filter Strip ▪ Filter Strip length is a function of the slope, vegetative cover, and soil type. ▪ Minimum recommended length of Filter Strip is 25 ft, however shorter lengths provide some water quality benefits as well. ▪ Maximum Filter Strip slope is based on soil type and vegetated cover. ▪ Filter strip slope should never exceed 8%. Slopes less than 5% are generally preferred. ▪ Level spreading devices are recommended to provide uniform sheet flow conditions at the interface of the Filter Strip and the adjacent land cover. ▪ Maximum contributing drainage area slope is generally less than 5%, unless energy dissipation is provided. ▪ Minimum filter strip width should equal the width of the contributing drainage area. ▪ Construction of filter strip should entail as little disturbance to existing vegetation at the site as possible. ▪ See Appendix B for list of acceptable filter strip vegetation. 	<p style="text-align: center;"><u>Potential Applications</u></p> <p style="text-align: center;">Residential: Yes Commercial: Yes Ultra Urban: Limited Industrial: Limited Retrofit: Yes Highway/Road: Yes</p> <hr/> <p style="text-align: center;"><u>Stormwater Functions</u></p> <p style="text-align: center;">Volume Reduction: Low/Med. Recharge: Low/Med. Peak Rate Control: Low Water Quality: High</p> <hr/> <p style="text-align: center;"><u>Water Quality Functions</u></p> <p style="text-align: center;">TSS: 30% TP: 20% NO3: 10%</p>
--	--

Other Considerations

- Regular maintenance required for continued performance

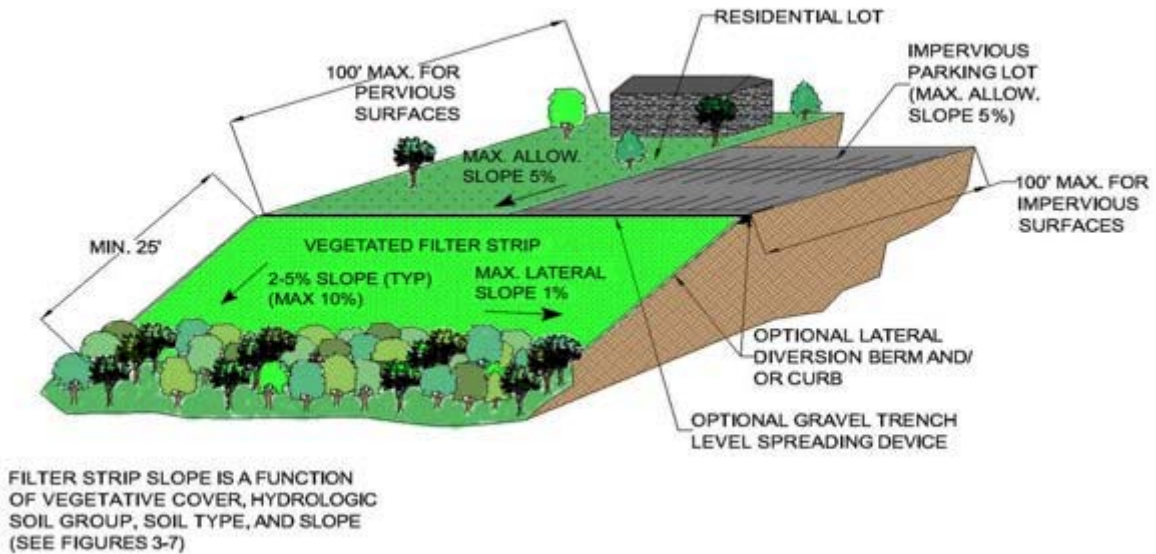

Description

Filter strips are gently sloping, densely vegetated areas that filter, slow, and infiltrate sheet flowing stormwater. Filter strips are best utilized to treat runoff from roads and highways, roof downspouts, small parking lots, and pervious surfaces. In highly impervious areas, they are generally not recommended as “stand alone” features, but as pretreatment systems for other BMPs, such as Infiltration Trenches or Bioretention Areas. Filter Strips are primarily designed to reduced TSS levels, however pollutant levels of hydrocarbons, heavy metals, and nutrients may also be reduced. Pollutant removal mechanisms include sedimentation, filtration, absorption, infiltration, biological uptake, and microbial activity. Depending on hydrologic soil group, vegetative cover type, slope, and length, a filter strip can allow for a modest reduction in runoff volume through infiltration.

The vegetation for Filter Strips may be comprised of:

- Turf Grasses
- Meadow grasses, shrubs, and native vegetation, including trees
- Indigenous areas of woods and vegetation.

Filter strips may be comprised of a variety of trees, shrubs, and native vegetation to add aesthetic value as well as water quality benefits. The use of turf grasses will increase the required length of the filter strip, as compared to other vegetation options. The use of indigenous vegetated areas that have surface features that disperse runoff is encouraged, as the use of these areas will also reduce overall site disturbance and soil compaction. Runoff must be distributed so that erosive conditions cannot develop.

The vegetation in Filter Strips must be dense and healthy. Indigenous wooded areas should have a healthy layer of leaf mulch or duff. Indigenous areas that have surface features that concentrate flow are not acceptable.

The following example shows three filter strips that vary only by cover type. Each strip is on type 'C' soils and has a slope of 6%. Using the recommended sizing approach, the filter strip covered with turf grass required a length of 100 ft, while the strip with indigenous woods required only 50 ft. The strip covered with native grasses and some trees required 75 ft. Where the required length is not available, a filter strip can still be used but it will be less effective.

Filter Strip Example #1: Turf Grass

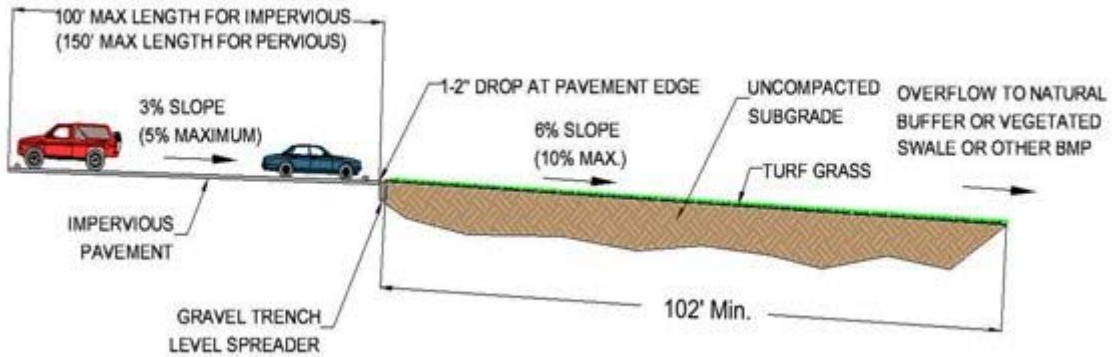

Filter Strip Example #2: Native Grasses and Planted Woods Grass

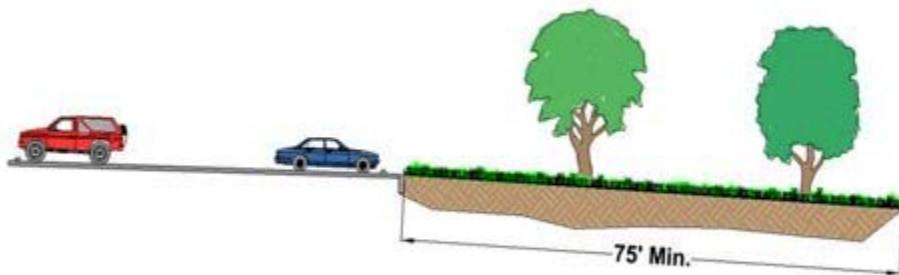

Filter Strip Example #3: Indigenous Woods

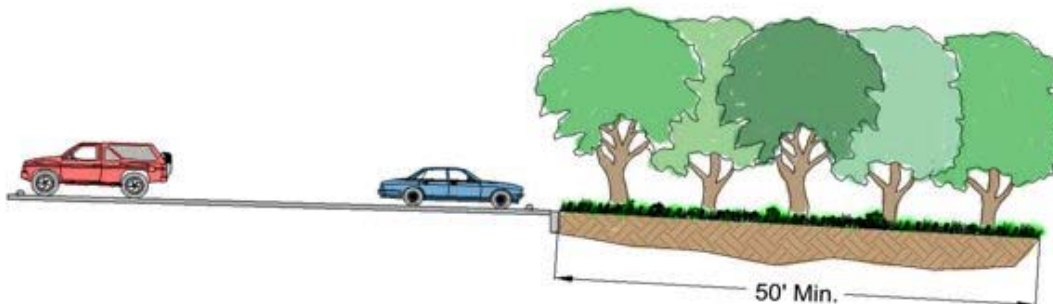

Variations

Filter strip effectiveness may be enhanced through the addition of a pervious berm at the toe of the slope. A pervious berm allows for greater runoff velocity and volume reduction and thus better pollutant removal ability, by providing a very shallow, temporarily ponded area. The berm should have a height of not more than six to twelve inches and be constructed of sand, gravel, and sandy loam to encourage vegetative cover. An outlet pipe(s) or overflow weir should be provided and sized to ensure that the area drains within 24 hours, or to convey larger storm events. The berm must be erosion resistant under the full range of storm events. Likewise, the ponded area should be planted with vegetation that is resistant to frequent inundation.

Check dams may be implemented on filter strips with slopes exceeding 5%. Check dams shall be constructed of durable, nontoxic materials such as rock, brick, wood, not more than six inches in height, and placed at appropriate intervals to encourage ponding and prevent erosion. Care must be taken to prevent erosion around the ends of the check dams.

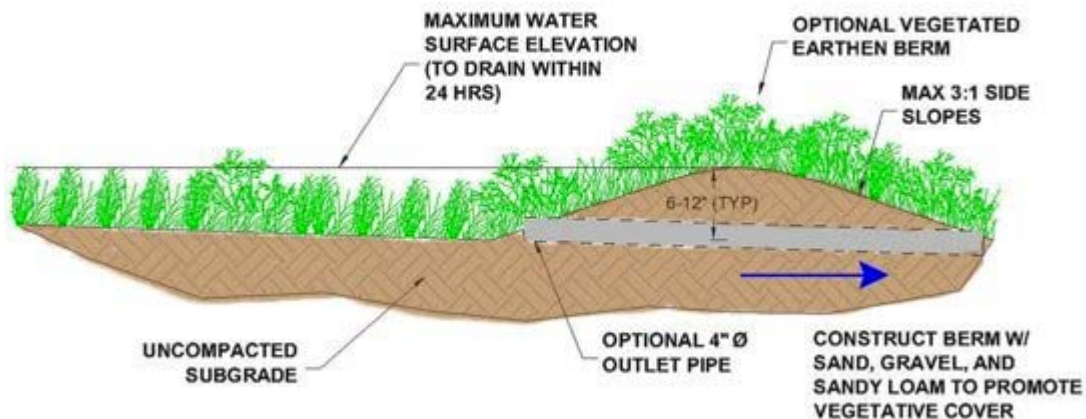

Applications

- Residential development lawn and housing areas
- Roads and highways
- Parking lots
- Pretreatment for other structural BMPs (Infiltration Trench, Bioretention, etc.)
- Commercial and light industrial facilities
- As part of a Riparian Buffer (located in Zone 3)

Design Considerations

1. The design of vegetated filter strips is determined by site conditions (contributing drainage area, length, slope, etc.) site soil group, proposed cover type, and filter strip slope. The filter length can be determined from the appropriate graph shown below the text.

2. Level spreading devices or other measures may be required to provide uniform sheet flow conditions at the interface of the filter strip and the adjacent land cover. Concentrated flows are explicitly discouraged from entering filter strips, as they can lead to erosion and thus failure of the system. Examples of level spreader applications include:

- a. A gravel-filled trench, installed along the entire upgradient edge of the strip. The gravel in the trenches may range from pea gravel (ASTM D 448 size no. 6, 1/8" to 3/8") for most cases to shoulder ballast for roadways. Trenches are typically 12" wide, 24-36" deep, and lined with a nonwoven geotextile. When placed directly adjacent to an impervious surface, a drop (between the pavement edge and the trench) of 1-2" is recommended, in order to inhibit the formation of the initial deposition barrier.

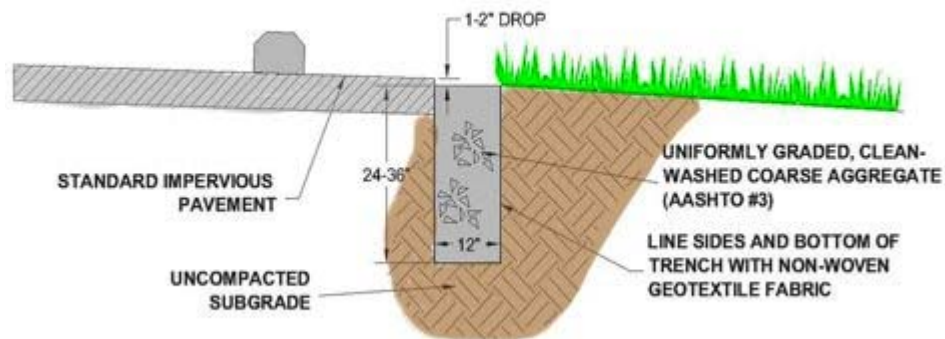

- b. Curb stops

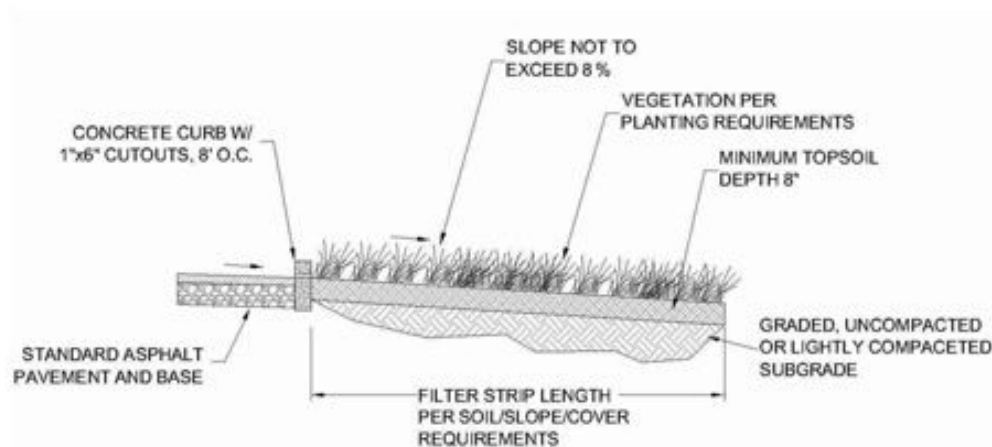

- c. Concrete sill (or lip)
- d. Slotted or depressed curbs
- e. An earthen berm with optional perforated pipe.

3. Although in some locations more “natural” spreader designs and materials, such as earthen berms, are desirable, they can be more susceptible to failure due to irregularities in berm elevation and density of vegetation. When it is desired to treat runoff from roofs or curbed impervious areas, a more structural approach, such as a gravel trench, is required. In this case, runoff shall be directly conveyed, via pipe from downspout or inlet, into the subsurface gravel and uniformly distributed by a perforated pipe along the trench bottom.
4. The upstream edge of a filter strip should be level and directly abut the contributing drainage area.
5. The seasonal high water table should be at least 2 to 4 ft lower than any point along the filter strip.
6. In areas where the soil infiltration rate has been compromised (e.g. by excessive compaction), the filter strip shall be tilled prior to establishment of vegetation. However, tilling will only have an effect on the top 12-18 inches of the soil layer. Therefore, other measures, such as planting trees and shrubs, may be needed to provide deeper aeration. Deep root penetration will promote greater absorptive capacity of the soil.
7. The ratio of contributing drainage area to filter strip area should not exceed 6:1.
8. The filter strip area should be densely vegetated with a mix of salt- and drought- tolerant and erosion-resistant plant species. Filter strip vegetation, whether planted or indigenous, may range from turf and native grasses to herbaceous and woody vegetation. The optimal vegetation strategy consists of plants with dense growth patterns, a fibrous root system for stability, good regrowth ability (following dormancy and cutting), and adaptability to local soil and climatic conditions. Native vegetation is always preferred. (See Appendix B for vegetation recommendations.)
9. Natural areas, such as forests and meadows, should not be unduly disturbed by the creation of a filter strip. If these areas are not already functional as natural filters, they may be enhanced by restorative methods or construction of a level spreader.
10. Maximum lateral slope of filter strip is 1%.
11. To prohibit runoff from laterally bypassing a strip, berms and/or curbs can be installed along the sides of the strip, parallel to the direction of flow.
12. Pedestrian and/or vehicular traffic on filter strips should be strictly discouraged. Since the function of filter strips can be easily overlooked or forgotten over time, a highly visible, physical “barrier” is suggested. This can be accomplished, at the discretion of the owner, by simple post and chain, signage, or even the level-spreading device itself.
13. Vegetated filter strips may be designed to discharge to a variety of features, including natural buffer areas, vegetated swales, infiltration basins, or other structural BMPs.
14. In cold climates, the following recommendations should be considered:
 - a. Filter strips often make convenient areas for snow storage. Thus, filter strip vegetation should be salt-tolerant and the maintenance schedule should involve removal of sand buildup at the toe of the slope.

- b. The bottom of the gravel trench (if used as the level spreader) should be placed below the frost line to prohibit water from freezing in the trench. The perforated pipe in the trench should be at least 8 inches in diameter to further discourage freezing.
- c. Other water quality options may be explored to provide backup to filter strips during the winter, when their pollutant removal ability is reduced.

Required Length as a Function of Slope, Soil Cover

Filter Strip Soil Type	Soil Group		
		Turf Grass, Native Grasses and Meadows	Planted and Indigenous Woods
Sand	A	7	5
Sandy Loam	B	8	7
Loam, Silt Loam	B	8	8
Sandy Clay Loam	C	8	8
Clay Loam, Silty Clay, Clay	D	8	8

Drainage Area Soil: Sand HSG: A

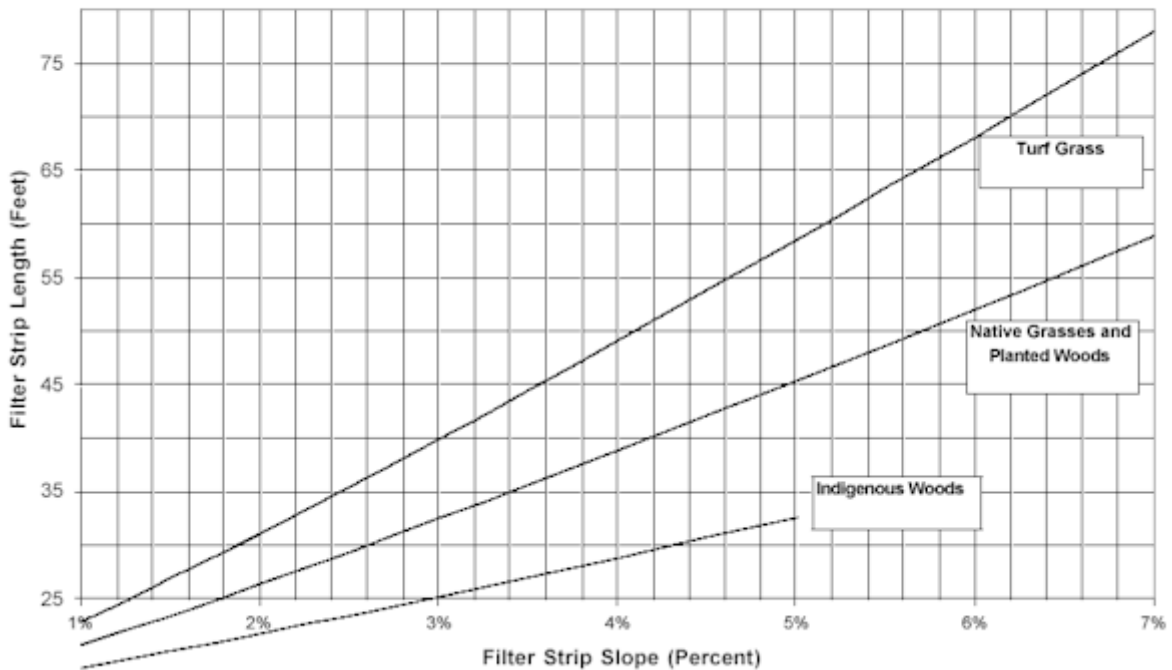

Drainage Area Soil: Sandy Loam HSG: B

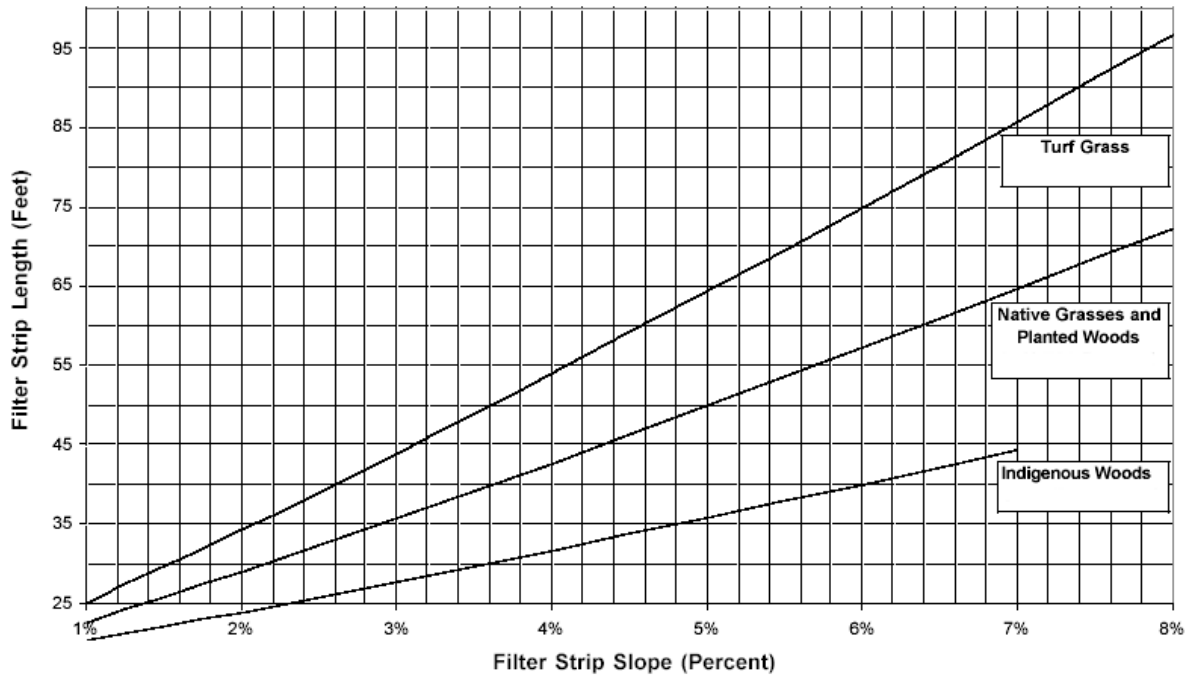

Drainage Area Soil: Loam, Silt Loam HSG: B

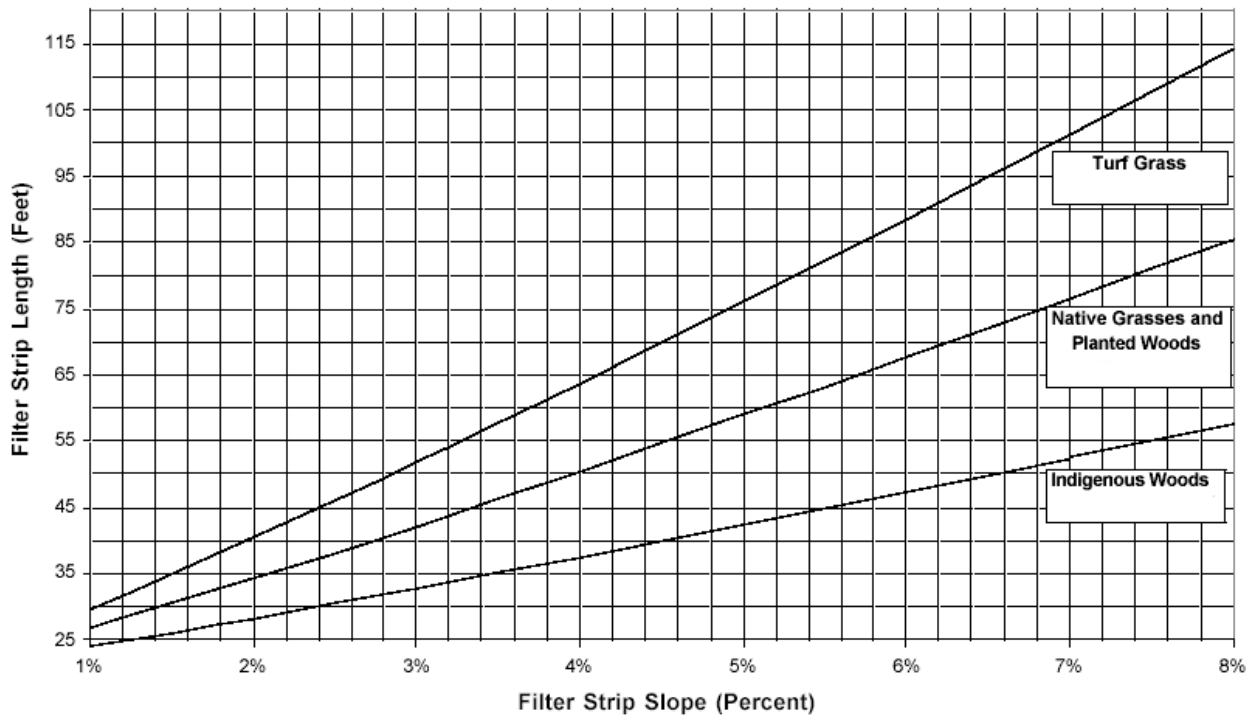

Drainage Area Soil: Sandy Clay Loam HSG: C

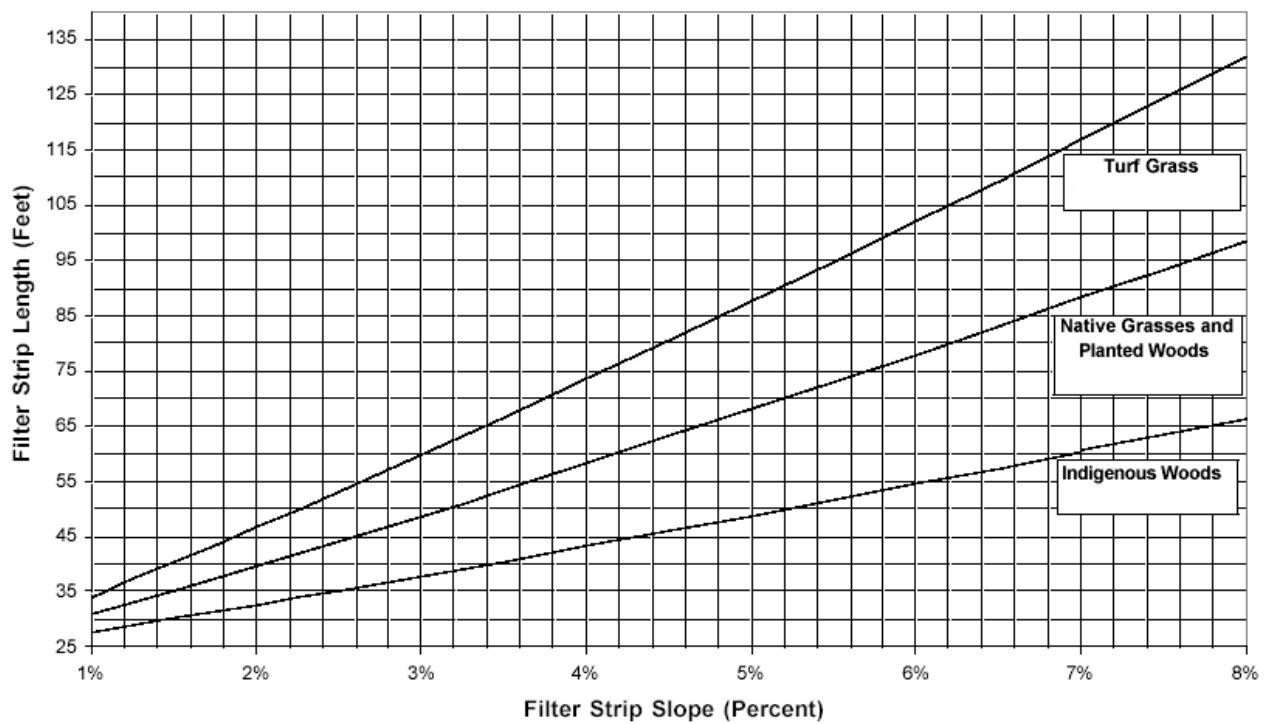

Drainage Area Soil: Clay Loam, Silty Clay, Clay HSG: D

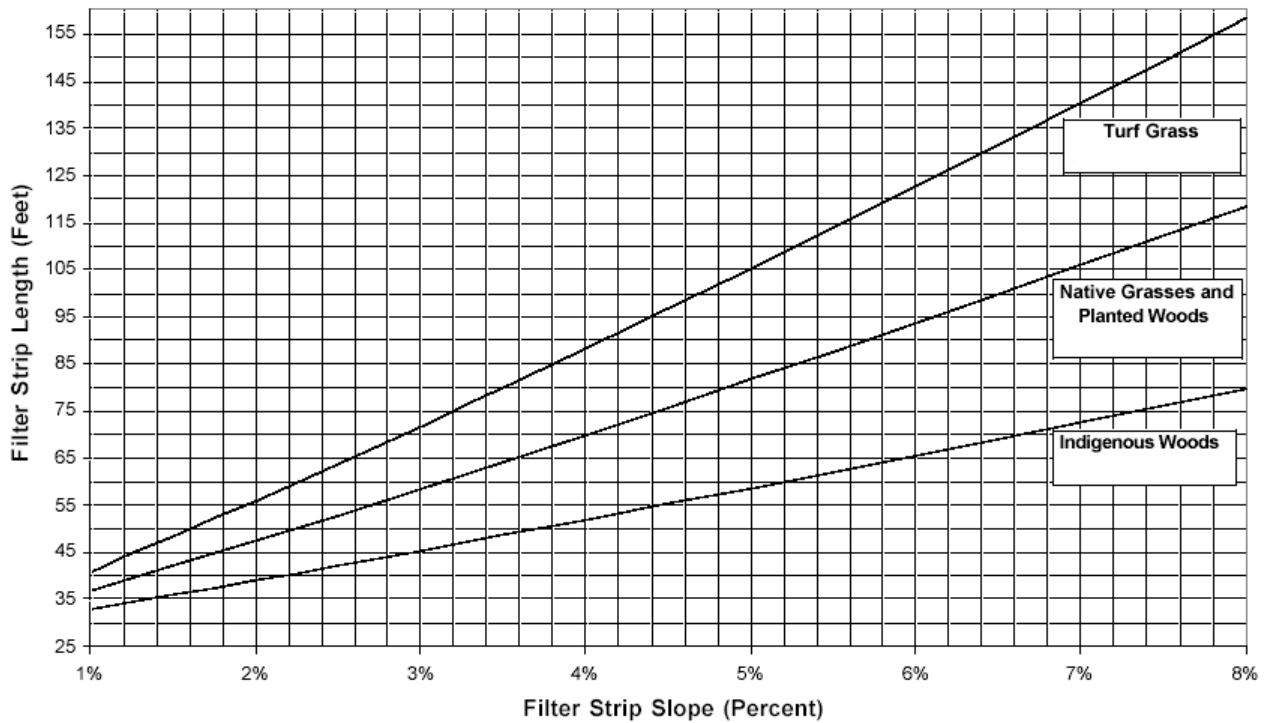

Detailed Stormwater Functions

Volume Reduction Calculations

To determine the volume reduction over the length of a filter strip the following equation is recommended:

Filter Strip Volume Reduction = Filter Strip Area x Infiltration Rate x Storm Duration

When a berm is positioned at the toe of the slope, the total volume reduction shall be defined as the amount calculated above plus the following:

Berm Storage Volume = (Cross-sectional Area Behind Berm x Length of Berm) + (Surface Area Behind Berm x Infiltration Rate x 12 hours)

The inundated area behind the berm should be designed to drain within 24 hours. An outlet pipe or overflow weir may be needed to provide adequate drain down. In that case, the infiltration volume behind the berm should be adjusted based on the invert of the overflow mechanism.

Peak Rate Mitigation Calculations

See in Section 8 for Peak Rate Mitigation methodology which addresses link between volume reduction and peak rate control.

Water Quality Improvement

See in Section 8 for Water Quality Improvement methodology which addresses pollutant removal effectiveness of this BMP.

Construction Sequence

1. Begin filter strip construction only when the upgradient site has been sufficiently stabilized and temporary erosion and sediment control measures are in place. (Erosion and sediment control methods shall adhere to the Pennsylvania Department of Environmental Protection's Erosion and Sediment Pollution Control Program Manual, March 2000 or latest edition.) The strip should be installed at a time of the year when successful establishment without irrigation is most likely. However, temporary irrigation may be needed in periods of little rain or drought.
2. For planted (not indigenous Filter Strips) clear and grub site as needed. Care should be taken to disturb as little existing vegetation as possible, whether in the designated filter strip area or in adjacent areas, and to avoid soil compaction. Grading a level slope may require removal of existing vegetation.
3. Rough grade the filter strip area, including the berm at the toe of the slope, if proposed. Use the lightest, least disruptive equipment to avoid excessive compaction and/or land disturbance.
4. Construct level spreader device at the upgradient edge of the strip. For gravel trenches, do not compact subgrade (Follow construction sequence for Infiltration Trench).
5. Fine grade the filter strip area. Accurate grading is crucial for filter strips. Even the smallest irregularities may compromise sheet flow conditions.

6. Seed or sod, as desired. Plant more substantial vegetation, such as trees and shrubs, if proposed. If sod is proposed, place tiles tightly enough to avoid gaps and stagger the ends to prevent channelization along the strip. Use a roller on sod to prevent air pockets between the sod and soil from forming.
7. Concurrent with #6, stabilize seeded filter strips with appropriate permanent soil stabilization methods, such as erosion control matting or blankets. Erosion control for seeded filter strips should be maintained for at least the first 75 days following the first storm event of the season.
8. Once the filter strip is sufficiently stabilized, remove temporary erosion and sediment controls. It is very important that filter strip vegetation be fully established before receiving upland stormwater flow. One full growing season is the recommended minimum time for establishment. Some seed mixtures may require a longer time period to become established.
9. Follow maintenance guidelines, as discussed below.

Note: When and if a filter strip is used for temporary sediment control, it might need to be regraded and reseeded immediately after construction and stabilization has occurred.

Maintenance Issues

As with other vegetated BMPs, filter strips should be properly maintained to ensure their effectiveness. In particular, it is critical that sheet flow conditions and infiltration are sustained throughout the life of the filter strip. Field observations of strips in more urban settings show that their effectiveness can deteriorate due to lack of maintenance, inadequate design/location, and poor vegetative cover. Compared with other vegetated BMPs, filter strips require only minimal maintenance efforts, many of which may overlap with standard landscaping demands.

Vegetated filter strip components that receive or trap sediment and debris should be inspected for clogging, density of vegetation, damage by foot or vehicular traffic, excessive accumulations, and channelization. Inspections should be made on a quarterly basis for the first two years following installation, and then on a biannual basis thereafter. Inspections should also be made after every storm event greater than 1 in during the establishment period. Guidance information, usually in written manual form, for operating and maintaining filter strips should be provided to all facility owners and tenants. Facility owners are encouraged to keep an inspection log, where they can record all inspection dates, observations, and maintenance activities.

Sediment and debris should be routinely removed (but never less than biannually), or upon observation, when buildup exceeds 2 inches in depth in either the strip itself or the level spreader. If erosion is observed, measures should be taken to improve the level spreader or other dispersion method to address the source of erosion. Rills and gullies observed along the strip may be filled with topsoil, stabilized with erosion control matting, and either seeded or sodded, as desired. For channels less than 12 inches wide, filling with crushed gravel, which allows grass to creep in over time, is acceptable. For wider channels, i.e. greater than 12 inches, regrading and reseeding may be necessary. (Small bare areas may only require overseeding.) Regrading may also be required when pools of standing water are observed along the slope. (In no case should standing water be tolerated for longer than 48-72 hours.) If check dams are proposed, they should be inspected for cracks, rot, structural damage, obstructions, or any other factors that cause altered flow patterns or channelization. Inlets or sediment sumps that drain to filter strips should be cleaned periodically or as needed.

Sediment should be removed when the filter strip is thoroughly dry. Trash and debris removed from the site should be deposited only at suitable disposal/recycling sites and must comply with applicable local, state, and federal waste regulations. In the case where a filter strip is used for sediment control, it should be regraded and reseeded immediately after construction has concluded.

Maintaining a vigorous vegetative cover on a filter strip is critical for maximizing pollutant removal efficiency and erosion prevention. Grass cover should be mowed, with low ground pressure equipment, as needed to maintain a height of 4-6 inches. Mowing should be done only when the soil is dry, in order to prevent tracking damage to vegetation, soil compaction, and flow concentrations. Generally speaking, grasses should be allowed to grow as high as possible, but mowed frequently enough to avoid troublesome insects or noxious weeds. Fall mowing should be controlled to a grass height of 6 inches, to provide adequate wildlife winter habitat. When and where cutting is desired for aesthetic reasons, a high blade setting should be used.

If vegetative cover is not fully established within the designated time, it should be replaced with an alternative species. It is standard practice to contractually require the contractor to replace dead vegetation. Unwanted or invasive growth should be removed on an annual basis. Biweekly inspections are recommended for at least the first growing season, or until the vegetation is permanently established. Once the vegetation is established, inspections of health, diversity, and density should be performed at least twice per year, during both the growing and non-growing season. Vegetative cover should be sustained at 85% and reestablished if damage greater than 50% is observed. Whenever possible, deficiencies in vegetation are to be mollified without the use of fertilizers or pesticides. These treatment options, as well as any other methods used to achieve optimum vegetative health, should only be used under special circumstances and if they do not compromise the functionality of the filter strip.

Two other maintenance recommendations involve soil aeration and drain down time. If a filter strip exhibits signs of poor drainage and/or vegetative cover, periodic soil aeration may be needed. In addition, depending on soil characteristics, the strip may need periodic liming. The design and maintenance plan of filter strips, especially those with flow obstructions should specify the approximate time it would take for the system to “drain down” the maximum design storm runoff volume. Post-rainfall inspections should include evaluations of the filter’s actual drain down time compared to the specified time. If significant differences (either increase or decrease) are observed, or if the 72 hour maximum time is exceeded, strip characteristics such as soils, vegetation, and groundwater levels should be reevaluated. Measures should be taken to establish, or reestablish as the case may be, the specified drain down time of the system.

Cost Issues

The real cost of filter strips is the land they require. When unused land is readily available at a site, filter strips may prove a sensible and cost-effective approach. However, where land costs are at a premium (i.e. not readily available), this practice may prove cost-prohibitive in the end. The cost of establishing a filter strip itself is relatively minor. Of course, the cost is even less when an existing grass or meadow area is identified as a possible filter strip area before development begins.

The cost of filter strips includes grading, sodding (when applicable), installation of vegetation (trees, shrubs, etc.), the construction of a level spreader, and the construction of a pervious berm, if proposed. Depending on whether seed or sod is applied, not to mention enhanced vegetation use or design variations, construction costs may range anywhere from \$0 (assuming the area was to be grassed regardless of use as treatment) to \$50,000 per acre. The annual cost of maintaining filter strips

(mowing, weeding, inspection, litter removal, etc.) generally runs from \$100 to \$1400 per acre and in fact, may overlap with standard landscape maintenance costs. Maintenance costs are highly variable, as they are a function of frequency and local labor rates.

Specifications

The following specifications are provided for information purposes only. These specifications include information on acceptable materials for typical applications, but are by no means exclusive or limiting. The designer is responsible for developing detailed specifications for individual design projects in accordance with the project conditions.

1. **Vegetation** – See Appendix B
2. **Erosion and Sediment** Control components shall conform to the Pennsylvania Department of Environmental Protection’s Erosion and Sediment Pollution Control Program Manual, March 2000 or latest edition.

For a gravel trench level spreader:

3. **Pipe** should be continuously perforated, smooth interior, high-density polyethylene (HDPE) with a minimum inside diameter of 8-inches. The pipe should meet AASHTO M252, Type S or AASHTO M294, Type S.
4. **Stone** for infiltration trenches should be 2-inch to 1-inch uniformly graded coarse aggregate, with a wash loss of no more than 0.5%, AASHTO size number 3 per AASHTO Specifications, Part I, 19th Ed., 1998, or later and should have voids $\geq 35\%$ as measured by ASTM-C29.

Pea gravel (clean bank-run gravel) may also be used. Pea gravel should meet ASTM D 448 and be sized as per No.6 or 1/8” to 3/8”.

5. **Non-Woven Geotextile** should consist of needled non-woven polypropylene fibers and meet the following properties:

a. Grab Tensile Strength (ASTM-D4632)	\geq	120 lbs
b. Mullen Burst Strength (ASTM-D3786)	\geq	225 psi
c. Flow Rate (ASTM-D4491)	\geq	95 gal/min/ft ²
d. UV Resistance after 500 hrs (ASTM-D4355)	\geq	70%
e. Heat-set or heat-calendared fabrics are not permitted		

Acceptable types include Mirafi 140N, Amoco 4547, and Geotex 451.
6. **Check dams** constructed of natural wood should be 6 in to 12 in inches diameter and notched as necessary. The following species are acceptable: Black Locust, Red Mulberry, Cedars, Catalpa, White Oak, Chestnut Oak, Black Walnut. The following species are not acceptable since they can rot over time: Ash, Beech, Birch, Elm, Hackberry, Hemlock, Hickories, Maples, Red and Black Oak, Pines, Poplar, Spruce, Sweetgum, and Willow. An earthen check dam should be constructed of sand, gravel, and sandy loam to encourage grass cover. (Sand: ASTM C-33 fine aggregate concrete sand 0.02 in to 0.04 in, Gravel: AASHTO M-43 0.5 in to 1.0 in). A stone check dam should be constructed of R-4 rip rap, or equivalent.

7. **Pervious Berms** The berm should have a height of 6-12 in and be constructed of sand, gravel, and sandy loam to encourage grass cover. (Sand: ASTM C-33 fine aggregate concrete sand 0.02"-0.04", Gravel: AASHTO M-43 ½" to 1")

References

New Jersey Department of Environmental Protection. *New Jersey Stormwater BMP Manual*. 2004

Environmental Services, City of Portland. *Stormwater Management Manual*. September 2002.

Virginia BMP Manual

Atlanta Regional Commission. *Georgia Stormwater Management Manual*. August 2001.

Delaware Department of Natural Resources. *DURMM: The Delaware Urban Runoff Management Model*. (March 2001)

The Vermont Agency of Natural Resources. *The Vermont Stormwater Management Manual*. April 2002.

California Stormwater Quality Association. *California Stormwater BMP Handbook*. January 2003.

Washington State Department of Ecology, 2002. *Stormwater Management Manual for Western Washington*, Olympia, WA

South Florida Water Management District, 2002. *Best Management Practices for Southern Florida Urban Stormwater Management Systems*, West Palm Beach, FL

United States Environmental Protection Agency (USEPA), 1999. *Storm Water Technology Fact Sheet: Sand Filters* (EPA 832-F-99-007)

Auckland Regional Council, 2003. *Stormwater Management Devices: Design Guidelines Manual*, Auckland, New Zealand

Center for Watershed Protection and Maryland Department of the Environment, 2000. *2000 Maryland Stormwater Design Manual*, Baltimore, MD

Ontario Ministry of the Environment, 2003. *Stormwater Management Planning and Design Manual 2003*, Toronto, Ontario

Barr Engineering Company, 2001. *Minnesota Urban Small Sites BMP Manual: Stormwater Best Management Practices for Cold Climates*, St. Paul, MN.

CRWR Online Report 97-5: Use of Vegetative Controls For Treatment of Highway Runoff (University of Texas at Austin)

BMP 6.4.10: Infiltration Berm & Retentive Grading

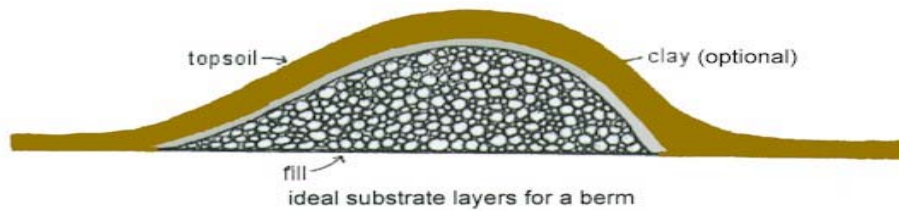

An Infiltration Berm is a mound of compacted earth with sloping sides that is usually located along a contour on relatively gently sloping sites. Berms can also be created through excavation/removal of upslope material, effectively creating a Berm with the original grade. Berms may serve various stormwater drainage functions including: creating a barrier to flow, retaining flow and allowing infiltration for volume control, and directing flows. Grading may be designed in some cases to prevent rather than promote stormwater flows, through creation of "saucers" or "lips" in site yard areas where temporary retention of stormwater does not interfere with use.

<p style="text-align: center;"><u>Key Design Elements</u></p> <ul style="list-style-type: none"> ▪ Maintain a minimum 2-foot separation to bedrock and seasonally high water table, provide distributed infiltration area (5:1 impervious area to infiltration area - maximum), site on natural, uncompacted soils with acceptable infiltration capacity, and follow other guidelines described in Protocol 2: Infiltration Systems Guidelines ▪ Berms should be relatively low, preferably no more than 24 inches in height. ▪ If berms are to be mowed, the berm side slopes should not exceed a ratio of 4:1 to avoid "scalping" by mower blades. ▪ The crest of the berm should be located near one edge of the berm, rather than in the middle, to allow for a more natural, asymmetrical shape. ▪ Berms should be vegetated with turf grass at a minimum, however more substantial plantings such as meadow vegetation, shrubs and trees are recommended. 	<p style="text-align: center;"><u>Potential Applications</u></p> <p style="text-align: center;">Residential: Yes Commercial: Yes Ultra Urban: Limited Industrial: Yes Retrofit: Yes Highway/Road: Yes</p> <hr/> <p style="text-align: center;"><u>Stormwater Functions</u></p> <p style="text-align: center;">Volume Reduction: Low/Med. Recharge: Low Peak Rate Control: Medium Water Quality: Med./High</p> <hr/> <p style="text-align: center;"><u>Water Quality Functions</u></p> <p style="text-align: center;">TSS: 60% TP: 50% NO3: 40%</p>
---	---

Other Considerations

- **Protocol 1. Site Evaluation and Soil Infiltration Testing** and **Protocol 2. Infiltration Systems Guidelines** should be followed, see Appendix C

Description

Infiltration Berms are linear landscape features located along (i.e. parallel to) existing site contours in a moderately sloping area. They can be described as built-up earthen embankments with sloping sides, which function to divert, retain and promote infiltration, slow down, or divert stormwater flows. Berms are also utilized for reasons independent of stormwater management, such as to add interest to a flat landscape, create a noise or wind barrier, separate land uses, screen undesirable views or to enhance or emphasize landscape designs. Berms are often used in conjunction with recreational features, such as pathways through woodlands. Therefore, when used for stormwater management, berms and other retentive grading techniques can serve multifunctional purposes and are easily incorporated into the landscape.

Infiltration Berms create shallow depressions that collect and temporarily store stormwater runoff, allowing it to infiltrate into the ground and recharge groundwater. Infiltration berms may be constructed in series along a gradually sloping area.

1. Infiltration berms can be constructed on disturbed slopes and revegetated as part of the construction process. Infiltration berms should not be installed on slopes where soils having low shear strength (or identified as “slip prone” or “landslide prone”, etc.) have been mapped.
2. They can be installed along the contours within an existing woodland area to slow and infiltrate runoff from a development site.
3. May be constructed in combination with a subsurface infiltration trench at the base of the berm.

Infiltration Berms can provide runoff rate and volume control, though the level to which they do is limited by a variety of factors, including design variations (height, length, etc.), soil permeability rates, vegetative cover, and slope. Berms are ideal for mitigating runoff from relatively small impervious areas with limited adjacent open space (e.g. roads, small parking lots). Systems of parallel berms have been used to intercept stormwater from roadways or sloping terrain. Berms can sometimes be threaded carefully along contour on wooded hillsides, minimally disturbing existing vegetation and yet still gaining stormwater management credit from the existing woodland used. Conversely, berms are often incapable of controlling runoff from very large, highly impervious sites. Due to their relatively limited volume capacity, the length and/or number of berms required to retain large quantities of runoff make them impractical as the lone BMP in these cases. In these situations, berms are more appropriately used as pre- or additional-treatment for other more distributed infiltration systems closer to the source of runoff (i.e. porous pavement with subsurface infiltration).

Retentive grading may be employed in portions of sites where infiltration has been deemed to be possible and where site uses are compatible. Ideally, such retentive grading will serve to create subtle “saucers,” which contain and infiltrate stormwater flows. The “lip” of such saucers effectively function as a very subtle berm, which can be vertically impervious when vegetated and integrated into the overall landscape.

Variations

Diversion Berms

Diversion Berms can be used to protect slopes from erosion and to slow runoff rate. They can also be used to direct stormwater flow in order to promote longer flow pathways, thus increasing the time of concentration. Diversion berms often:

1. Consist of compacted earth ridges usually constructed across a slope in series to intercept runoff.
2. Can be incorporated within other stormwater BMPs to increase travel time of stormwater flow by creating natural meanders while providing greater opportunity for pollutant removal and infiltration.



Applications

- **Meadow/Woodland Infiltration Berms**

Infiltration Berms effectively control both the rate and volume of stormwater runoff. The berms are constructed along the contours and serve to collect and retain stormwater runoff, allowing it to infiltrate through the soil mantle and recharge the groundwater. Depressed areas adjacent to the berms should be level so that concentrated flow paths are not encouraged. Infiltration berms may have a variety of vegetative covers but meadow and woodland are recommended in order to reduce maintenance. If turf grass is used, berms in series should be constructed with enough space between them to allow access for maintenance vehicles. Also, berm side slopes should not exceed a 4:1 ratio. Woodland infiltration berms can sometimes be installed within existing wooded areas for additional stormwater management. Berms in wooded areas can even improve the health of existing vegetation, through enhanced groundwater recharge. Care should be taken during construction to ensure minimum disturbance to existing vegetation, especially tree roots.

- **Slope Protection**
 Diversion Berms can be used to help protect steeply sloping areas from erosion. Berms may divert concentrated discharge from a developed area away from the sloped area. Additionally, berms may be installed in series down the slope to retain flow and spread it out along multiple level berms to discourage concentrated flow.

- **Flow Pathway Creation**
 Berms may be utilized to create or enhance stormwater flow pathways within existing or proposed BMPs, or as part of an LID (Low Impact Development) strategy. Berms can be installed such that vegetated stormwater flow pathways are allowed to “meander” so that stormwater travel time is increased. For example, berms can be utilized within existing BMPs as part of a retrofit strategy to eliminate short-circuited inlet/outlet situations within detention basins provided care is taken to ensure the required storage capacity of the basin is maintained. Flow pathway creation can be utilized as part of an LID strategy to disconnect roof leaders and attenuate runoff, while increasing pervious flow pathways within developed areas. Berms should be designed to compliment the landscape while diverting runoff across vegetated areas and allowing for longer travel times to encourage pollutant removal and infiltration.

- **Constructed Wetland Berms**
 Berms are often utilized within constructed wetland systems in order to create elongated flow pathways with a variety of water depths. See BMP 6.6.1 – Constructed Wetlands.

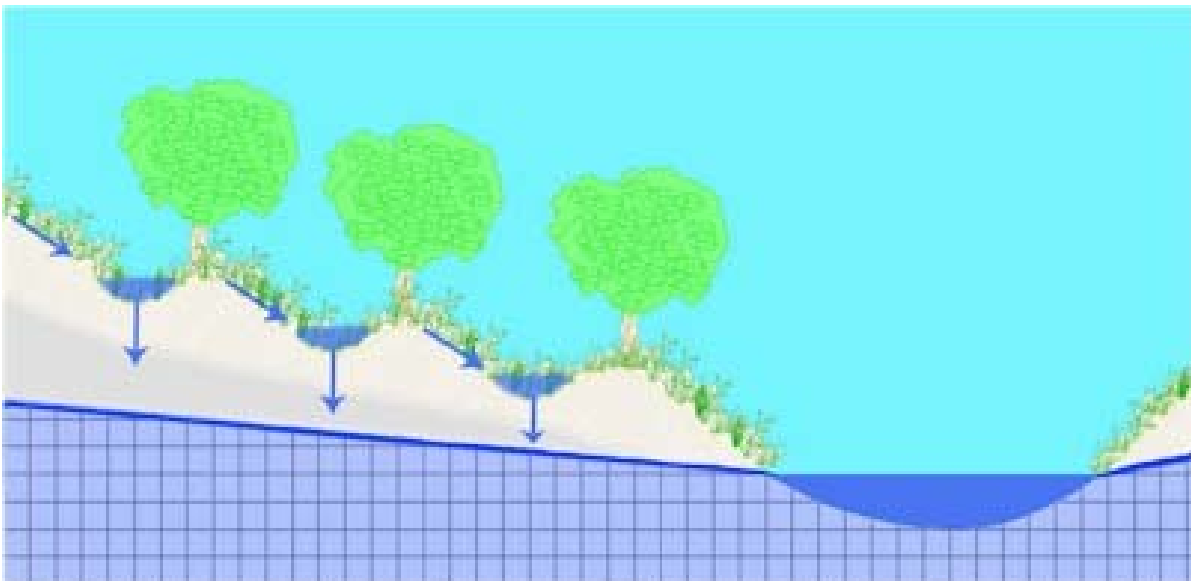

Design Considerations

1. Sizing criteria are dependent on berm function, location and storage volume requirements.
 - a. Low **berm height** (less than or equal to 24 inches) is recommended to encourage maximum infiltration and to prevent excessive ponding behind the berm. Greater heights may be used where berms are being used to divert flow or to create “meandering” or lengthened flow pathways. In these cases, stormwater is designed to flow adjacent to (parallel to), rather than over the crest of the berm. Generally, more berms of smaller size are preferable to fewer berms of large size.

b. **Berm length** is dependent on functional need and site size. Berms installed along the contours should be level and located across the slope. Maximum length will depend on width of the slope. Generally speaking, diversion berm length will vary with the size and constraints of the site in question.

2. **Infiltration Berms** should be constructed along (parallel to) contours at a constant elevation.
3. **Soil.** A berm may consist entirely of high quality topsoil. To reduce cost, only the top foot needs to consist of high quality Topsoil, with well-drained soil making up the remainder of the berm. The use of gravel is not recommended in the layers directly underneath the topsoil because of the tendency of the soil to wash through the gravel. In some cases, the use of clay may be required due to its cohesive qualities (especially where the berm height is high or relatively steeply sloped). However, well-compacted soil usually is sufficient provided that the angle of repose (see below) is not exceeded for the soil medium used.

A more sustainable alternative to importing berm soil from off-site is to balance berm cut and fill material as much as possible, provided on-site soil is deemed suitable as per the Specifications below. Ideally, the concave segment (infiltration area) of the berm is excavated to a maximum depth of 12 inches and then used to construct the convex segment (crest of berm).

4. The **Angle of Repose of Soil** is the angle at which the soil will rest and not be subject to slope failure. The angle of repose of any soil will vary with the texture, water content, compaction, and vegetative cover. Typical angles of repose are given below:
 - a. Non-compacted clay: 5-20%
 - b. Dry Sand: 33%
 - c. Loam: 35-40%
 - d. Compacted clay: 50-80%
5. **Side Slopes.** The angle of repose for the soil used in the berm should determine the maximum slope of the berm with additional consideration to aesthetic, drainage, and maintenance needs. If a berm is to be mowed, the slope should not exceed a 4:1 ratio (horizontal to vertical) in order to avoid "scalping" by mower blades. If trees are to be planted on berms, the slope should not exceed a 5:1 ratio. Other herbaceous plants, which do not require mowing, can tolerate slopes of 3:1. Berm side slopes should not exceed a 2:1 ratio.
6. **Plant Materials.** It is important to consider the function and form of the berm when selecting plant materials. If using trees, plant them in a pattern that appears natural and accentuates the berm's form. Consider tree species appropriate to the proposed habitat. If turf will be combined with woody and herbaceous plants, the turf should be placed to allow for easy maneuverability while mowing. Low maintenance plantings, such as trees and meadow plants, rather than turf and formal landscaping, are encouraged.
7. **Infiltration Design.** Infiltration berms located along slopes should be composed of low berms (less than 12 inches high) and should be vegetated. Subsurface soils should be uncompacted to encourage infiltration behind the berms. Soil testing is not required where berms are located within an existing woodland, but soil maps/data should be consulted when siting the berms. Where feasible, surface soil testing should be conducted in order to estimate potential infiltration rates.

8. **Infiltration Trench Option.** Soil testing is recommended for infiltration berms that will utilize a subsurface infiltration trench. Infiltration trenches are not recommended in existing woodland areas as excavation and installation of subsurface trenches could damage tree root systems. See BMP 6.4.4 – Infiltration Trench, for information on infiltration trench design.
9. **Aesthetics.** To the extent possible, berms should reflect the surrounding landscape. Berms should be graded so that the top of the berm is smoothly convex and the toes of the berms are smoothly concave. Natural, asymmetrical berms are usually more effective and attractive than symmetrical berms. The crest of the berm should be located near one end of the berm rather than in the middle.

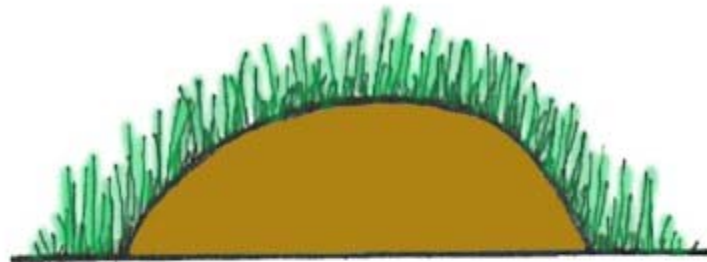

undesirable shape for a berm

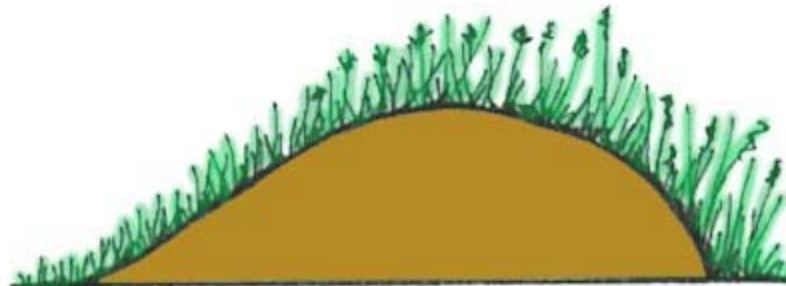

desirable shape for a berm

Detailed Stormwater Functions

Infiltration Area

The Infiltration Area is the ponding area behind the berm, defined as:
 Length of ponding x Width ponding area = Infiltration Area (Ponding Area)

Volume Reduction Calculations

Storage volume can be calculated for Infiltration Berms. The storage volume is defined as the ponding area created behind the berm, beneath the discharge invert (i.e. the crest of the berm). Storage volume can be calculated differently depending on the variations utilized in the design.

Surface Storage Volume is defined as the volume of water stored on the surface at the ponding depth. This is equal to:

Cross-sectional area of ponded water x Berm length = Surface Storage Volume

Peak Rate Mitigation:

See Section 8 for Peak Rate Mitigation methodology which addresses link between volume reduction and peak rate control.

Water Quality Improvement:

See Section 8 for Water Quality Improvement methodology which addresses pollutant removal effectiveness of this BMP.

Construction Sequence

The following is a typical construction sequence for a infiltration berm without a subsurface infiltration trench, though alterations will be necessary depending on design variations.

1. Install temporary sediment and erosion control BMPs as per the Pennsylvania Erosion and Sediment Pollution Control Program Manual.
2. Complete site grading and stabilize within the limit of disturbance except where Infiltration Berms will be constructed; make every effort to minimize berm footprint and necessary zone of disturbance (including both removal of existing vegetation and disturbance of empty soil) in order to maximize infiltration.
3. Lightly scarify the soil in the area of the proposed berm before delivering soil to site.
4. Bring in fill material to make up the major portion of the berm. Soil should be added in 8-inch lifts and compacted after each addition according to design specifications. The slope and shape of the berm should be graded out as soil is added.
5. Protect the surface ponding area at the base of the berm from compaction. If compaction of this area does occur, scarify soil to a depth of at least 8 inches.
6. Complete final grading of the berm after the top layer of soil is added. Tamp soil down lightly and smooth sides of the berm. The crest and base of the berm should be at level grade.
7. Plant berm with turf, meadow plants, shrubs or trees, as desired.
8. Mulch planted and disturbed areas with compost mulch to prevent erosion while plants become established.

Maintenance Issues

Infiltration Berms have low to moderate maintenance requirements, depending on the design.

Infiltration Berms

- Regularly inspect to ensure they are infiltrating; monitor drawdown time after major storm events
- Inspect any structural components, such as inlet structures to ensure proper functionality
- If planted in turf grass, maintain by mowing. Other vegetation will require less maintenance. Trees and shrubs may require annual mulching, while meadow planting requires annual mowing and clippings removal.
- Avoid running heavy equipment over the infiltration area at the base of the berms. The crest of the berm may be used as access for heavy equipment when necessary to limit disturbance.
- .
- Routinely remove accumulated trash and debris.
- Remove invasive plants as needed
- Inspect for signs of flow channelization; restore level gradient immediately after deficiencies are observed

Diversion Berms

- Regularly inspect for erosion or other failures.
- Regularly inspect structural components to ensure functionality.
- Maintain turf grass and other vegetation by mowing and re-mulching.
- .
- Remove invasive plants as needed.
- Routinely remove accumulated trash and debris.

Cost Issues

Infiltration berms can be less expensive than other BMPs options because extensive clearing and grubbing is not necessary. Cost will depend on height, length and width of berms as well as desired vegetation.

Specifications

The following specifications are provided for information purposes only. These specifications include information on acceptable materials for typical applications, but are by no means exclusive or limiting. The designer is responsible for developing detailed specifications for individual design projects in accordance with the project conditions.

1. Soil Materials

- a. Satisfactory soil materials are defined as those complying with ASTM D2487 soil classification groups GW, GP, GM, SM, SW, and SP.
- b. Unsatisfactory soil materials are defined as those complying with ASTM D2487 soil classification groups GC, SC, ML, MH, CL, CH, OL, OH, and PT.
- c. Topsoil: Topsoil stripped and stockpiled on the site should be used for fine grading. Topsoil is defined as the top layer of earth on the site, which produces heavy growths of crops, grass or other vegetation.

- d. Soils excavated from on-site may be used for berm construction provided they are deemed satisfactory as per the above recommendations or by a soil scientist.

2. Placing and Compacting of Berm Area Soil

- a. Ground Surface Preparation: Remove vegetation, debris, unsatisfactory soil materials, obstructions, and deleterious materials from ground surface prior to placement of fill. Plow strip, or break up sloped surfaces steeper than 1 vertical to 4 horizontal so that fill material will bond with existing surface.
- b. When existing ground surface has a density less than that specified under g. (below) for particular area classification, break up ground surface, pulverize, bring the moisture-condition to optimum moisture content, and compact to required depth and percentage of maximum density.
- c. Place backfill and fill materials in layers not more than 8 inches in loose depth for material to be compacted by heavy compaction equipment, and not more than 4 inches in loose depth for material to be compacted by hand-operated tampers.
- d. Before compaction, moisten or aerate each layer as necessary to provide optimum moisture content. Compact each layer to required percentage of maximum dry density or relative dry density for each area classification. Do not place backfill or fill material on surfaces that are muddy, frozen, or contain frost or ice.
- e. Place backfill and fill materials evenly adjacent to structures, piping, or conduit to required elevations. Prevent wedging action of backfill against structures or displacement of piping or same elevation in each lift.
- f. Control soil and fill compaction, providing minimum percentage of density specified for each area classification indicated below. Correct improperly compacted areas or lifts if soil density tests indicate inadequate compaction.
- g. Percentage of Maximum Density Requirements: Compact soil to not less than the following percentages of maximum density, in accordance with ASTM D 1557:
 - Under lawn or unpaved areas, compact top 6 inches of subgrade and each layer of backfill or fill material at 85 percent maximum density.
 - Under infiltration areas no compaction shall be permitted.

3. Grading

- a. General: Uniformly grade areas within limits of grading under this section, including adjacent transition areas. Smooth finished surface within specified tolerances; compact with uniform levels or slopes between points where elevations are indicated or between such points and existing grades.
- b. Lawn or Unpaved Areas: Finish areas to receive topsoil to within not more than 0.10 foot above or below required subgrade elevations.
- c. Compaction: After grading, compact subgrade surfaces to the depth and indicated percentage of maximum or relative density for each area classification.

4. Temporary Seeding

- a. Temporary seeding and mulching shall be required on all freshly graded areas immediately following earth moving procedures. Seed-free straw or salt hay mulch shall be applied at a rate of 75 lbs. per 1,000 square feet over temporary seeded areas. Straw bale barriers shall be placed in swale areas until vegetation is established.
- b. Should temporary seeding not be possible or not establish itself properly, mulch as described above, pending fine grading or permanent seeding.

5. Finish Grading

- a. Spreading of topsoil and finish grading shall be coordinated with the work of the Landscape Contractor.
- b. Verify that the rough grades meet requirements for tolerances, materials, and compaction.
- c. Surface of subgrades shall be loosened and made friable by cross-discing or harrowing to a depth of 2 inches. Stones and debris more than 1-1.5 inches in any dimension shall be raked up and grade stakes and rubbish removed.
- d. Topsoil shall be uniformly spread to minimum depths after settlement of 6 inches on areas to be seeded and 4 inches on areas to be sodded. Correct any surface irregularities to prevent formation of low spots and pockets that would retain water.
- e. Topsoil shall not be placed when the subgrade is frozen, excessively wet, or extremely dry and no topsoil shall be handled when in a frozen or muddy condition. During all operations following topsoil spreading, the surface shall be kept free from stones over 1-1.5 inches in size or any rubbish, debris, or other foreign material.
- f. After placing topsoil rake soil to a smooth, even-draining surface and compact lightly with an empty water roller. Leave finish graded areas clean and well raked, ready for lawn work.

References

AMEC Earth and Environmental Center for Watershed Protection et al. *Georgia Stormwater Management Manual*. 2001.

Harris, C. and Dines, N. *Time Saver Standards for Landscape Architecture, 2nd Edition*. New York, NY: McGraw-Hill, 1998.

University of Minnesota. "Building Soil Berms." *Sustainable Urban Landscape Information Series (SULIS)*. 1998. <http://www.sustland.umn.edu/implement/soil_berms.html>

Chester County Conservation District. *Chester County Stormwater BMP Tour Guide-Infiltration Trenches (Infiltration Berms)*. 2002.

Williams, G.P. *Canadian Building Digest - Drainage and Erosion at Construction Sites*. National Research Council Canada. 2004. <<http://irc.nrc-cnrc.gc.ca/cbd/cbd183e.html>>

6.5 Volume/Peak Rate Reduction BMPs

BMP 6.5.1: Vegetated Roof



An extensive vegetated roof cover is a veneer of vegetation that is grown on and completely covers an otherwise conventional flat or pitched roof ($\leq 30^\circ$ slope), endowing the roof with hydrologic characteristics that more closely match surface vegetation than the roof. The overall thickness of the veneer may range from 2 to 6 inches and may contain multiple layers, consisting of waterproofing, synthetic insulation, non-soil engineered growth media, fabrics, and synthetic components. Vegetated roof covers can be optimized to achieve water quantity and water quality benefits. Through the appropriate selection of materials, even thin vegetated covers can provide significant rainfall retention and detention functions.

<p style="text-align: center;"><u>Key Design Elements</u></p> <ul style="list-style-type: none"> ▪ 2-6 inches of engineered media; assemblies that are 4 inches and deeper may include more than one type of engineered media ▪ Engineered media should have a high mineral content. Engineered media for extensive vegetated roof covers is typically 85% to 97% non-organic (wet combustion or loss on ignition methods). ▪ Vegetated roof covers intended to achieve water quality benefits should not be fertilized ▪ Irrigation is not a desirable component of vegetated covers used as best management practices ▪ Internal building drainage, including provisions to cover and protect deck drains or scuppers, must anticipate the need to manage large rainfall events without inundating the cover. ▪ Assemblies planned for roofs with pitches steeper than 2:12 must incorporate supplemental measures to insure stability against sliding. Structural considerations are required. 	<p style="text-align: center;"><u>Potential Applications</u></p> <p style="text-align: center;">Residential: Yes Commercial: Yes Ultra Urban: Yes Industrial: Yes Retrofit: Yes Highway/Road: None</p> <hr/> <p style="text-align: center;"><u>Stormwater Functions</u></p> <p style="text-align: center;">Volume Reduction: Med/High Recharge: None Peak Rate Control: Low Water Quality: Medium</p> <hr/> <p style="text-align: center;"><u>Water Quality Functions</u></p> <p style="text-align: center;">TSS: 85% TP: 85% NO3: 30%</p>
--	---

Other Considerations

- The roof structure must be evaluated for compatibility with the maximum predicted dead and live loads. Typical dead loads for wet extensive vegetated covers range from 8 to 36 pounds per square foot. Live load is a function of rainfall retention. For example, 2 inches of rain equals 10.4 lbs. per square foot of live load. It requires 20 inches of snow to have the same live load per square foot.
- The waterproofing must be resistant to biological and root attack. In many instances a supplemental root-fast layer is installed to protect the primary waterproofing membrane from plant roots.
- Standards and guidelines (in English) for the design of green roofs are available from FLL¹, a European non-profit trade organization. In the United States, guidelines are in development by ASTM (American Standard Testing Methods).

Description

Extensive vegetated roof covers are usually 6 inches or less in depth and are typically intended to achieve a specific environmental benefit, such as rainfall runoff mitigation. For this reason they are most commonly not irrigated. While some installations are open to public access, most extensive vegetated roof covers are for public viewing only. In order to make them practical for installation on conventional roof structures, lightweight materials are used in the preparation of most engineered media. Developments in the last 40 years that have made these systems viable include: 1) recognition of the value of vegetated covers in restoring near open-space hydrologic performance on impervious surfaces, 2) advances in waterproofing materials and methods, and 3) development of a reliable temperate climate plant list that can thrive under the extreme growing conditions on a roof.

Vegetated roof covers that are 10 inches, or deeper, are referred to as ‘intensive’ vegetated roof covers. These are more familiar in the United States and include many urban landscaped plazas. Intensive assemblies can also provide substantial environmental benefits, but are intended primarily to achieve aesthetic and architectural objectives. These types of systems are considered “roof gardens” and are not to be confused with the simple “extensive” design. Benefits beyond the stormwater considerations include temperature moderation and roof longevity.

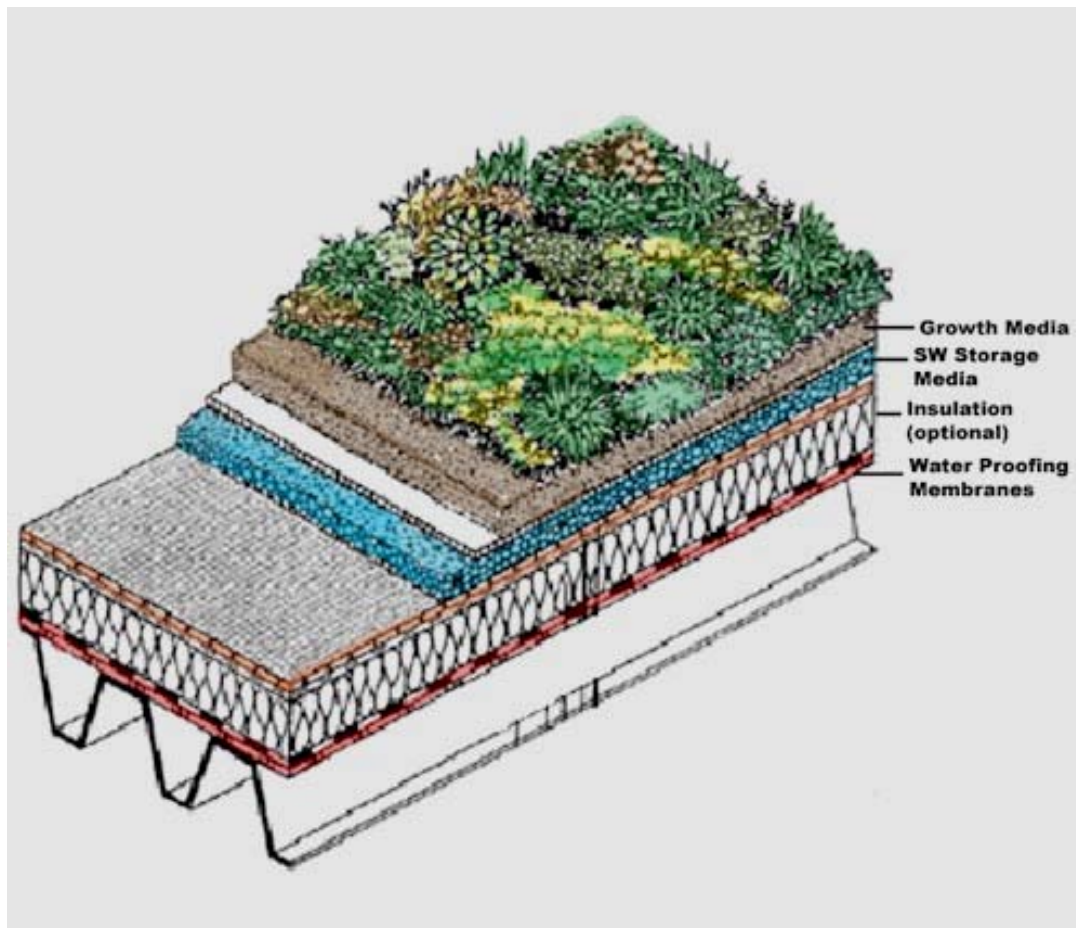

Variations

Most extensive vegetated roof covers fall into three categories

- Single media with synthetic under-drain layer
- Dual media
- Dual media with synthetic retention/detention layer

All vegetated roof covers will require a premium waterproofing system. Depending on the waterproofing materials selected, a supplemental root-fast layer may be required to protect the primary waterproofing membrane from plant roots.

Insulation, if included in the roof covering system, may be installed either above or below the primary waterproofing membrane. Most vegetated roof cover system can be adapted to either roofing configuration. In the descriptions that follow, the assemblies refer to the conventional configuration, in which the insulation layer is below the primary waterproofing.

All three extensive roof cover variations can be installed without irrigation. Non irrigated assemblies are strongly recommended. While this may place some limits on the type of plants that can be grown, the benefits are that the assembly will perform better as a stormwater BMP, and the maintenance requirements will be substantially reduced.

Some assemblies are installed in tray-like modules to facilitate installation, especially in confined locations.

Single media assemblies

Single media assemblies are commonly used for pitched roof applications and for thin and lightweight installations. These systems typically incorporate very drought tolerant plants and utilize coarse engineered media with high permeability. A typical profile would include the following layers.

- Waterproofing membrane
- **Root-barrier** (optional, depending on the root-fastness of the waterproofing)
- Semi-rigid plastic **geocomposite drain** or **mat** (typical mats are made from non-biodegradable fabric or plastic foam)
- Separation geotextile
- Engineered **growth media**
- Foliage layer

Pitched roof applications may require the addition of slope bars, rigid slope stabilization panels, cribbing, reinforcing mesh, or similar method minimizing sliding instability.

Flat roof applications with mats as foundations typically require a network of perforated internal drainage conduit to enhance drainage of percolated rainfall to the deck drains or scuppers.

Assemblies with mats can be irrigated from beneath, while assemblies with drainage composites require direct drainage.

Dual media assemblies

Dual media assemblies utilize two types of non-soil media. In this case a finer-grained media with some organic content is placed over a basal layer of coarse lightweight mineral aggregate. They do not include a geocomposite drain. The objective is to improve drought resistance by replicating a natural

growing environment in which sandy topsoil overlies gravelly subsoil. These assemblies are typically 4 to 6 inches thick and include the following layers:

- Waterproofing membrane
- Protection layer
- Coarse-grained **drainage media**
- Root-permeable nonwoven separation geotextile
- Fine-grained engineered growth media layer
- Foliage layer



These assemblies are suitable for roofs with pitches less than, or equal to, 1.5:12. Large vegetated covers will generally incorporate a network of perforated internal drainage conduit.

Dual media systems are ideal for use in combination with base irrigation methods.

Dual media with synthetic retention/detention layer

These assemblies introduce plastic panels with cup-like receptacles on their upper surface (i.e., a modified geocomposite drain sheet). The panels are in-filled with coarse lightweight mineral aggregate. The cups trap and retain water. They also introduce an air layer at the bottom of the assembly. A typical profile would include:

- Waterproofing membrane
- Felt fabric
- Retention/detention panel
- Coarse-grained drainage media
- Separation geotextile
- Fine grained 'growth' media layer
- Foliage layer

These assemblies are suitable on roof with pitches less than or equal to 1:12. Due to their complexity, these system are usually 5 inches or deeper.

If needed, irrigation can be provided via surface spray or mid-level drip.

- **Stormwater Volume and Rate Control**

Vegetated roof covers are an “at source” measure for reducing the rate and volume of runoff released during rainfall events. The water retention and detention properties of vegetated roof covers can be enhanced through proper selection of the engineered media and plants.

- **Runoff Water Quality Improvements**

Direct runoff from roofs is often a contributor to NPS pollutant discharges. Vegetated roof covers can significantly reduce this source of pollution. Assemblies intended to produce water quality benefits should employ engineered media with 100% mineral content. Following the plant establishment period (usually about 18 months), on-going fertilization of the cover should not be permitted. Experience indicates that it will take five or more years for a water quality vegetated cover to attain its maximum potential pollutant removal efficiency.

- **In Combination with Infiltration Measures**

Vegetated roof covers are frequently combined with ground infiltration measures. Vegetated roof covers improve the efficiency of infiltration devices by:

- Reducing the peak runoff rate
- Prolonging the runoff
- Filtering runoff to produce a clear effluent

Roofs that are designed to achieve water quality improvements will also reduce pollutant inputs to infiltration devices.

- **Habitat Restoration/Creation**

Vegetated roof covers have been used to create functional meadows and wetlands to mitigate the development of open space. This can be accomplished with assemblies as thin as 6 inches.

Design Considerations

1. Live and **dead load** bearing capacity of the roof need to be established. Dead loads should be estimated using media weights determined using a standardized laboratory procedure.¹
2. **Waterproofing** materials must be durable under the conditions associated with vegetated covers. A supplemental root-barrier layer should be installed in conjunction with materials that are not root-fast.
3. Roof flashings should extend 6 inches higher than the top of the growth media surface and be protected by counter-flashings.
4. The design should incorporate measures to protect the waterproofing membrane from physical damage during and after installation of the vegetated cover assembly.
5. Vegetated roof covers should incorporate internal drainage capacity sufficient to accommodate a two-year return frequency rainfall without generating surface runoff flow.
6. Deck drains, scuppers, or gravel stops serving as methods to discharge water from the roof area should be protected with **access chambers**. These enclosures should include removable lids in order to allow ready access for inspection.

7. The physical properties of the engineered media should be selected appropriately in order to achieve the desired hydrologic performance.
8. Engineered media should contain no clay size particles and should contain no more than 15% **organic matter** (wet combustion or loss on ignition methods)
9. Media used in constructing vegetated roof covers should have a maximum moisture capacity² of between 30% and 40%.
10. Plants should be selected which will create a vigorous, drought-tolerant ground cover. In Pennsylvania the most successful and commonly used ground covers for non irrigated projects are varieties of *Sedum* and *Delosperma*. In the Pennsylvania climate *Delosperma* is deciduous. Both deciduous and evergreen varieties of *Sedum* are available. Deeper assemblies (i.e., 4 to 6 inches) can also incorporate a wider range of plants including *Dianthus*, *Phlox*, *Antennaria*, and *Carex*.
11. Roofs with pitches exceeding 2:12 should be provided with supplemental measures to insure stability against sliding



Detailed Stormwater Functions

The performance of vegetated roof covers as stormwater best management practices cannot be represented by a simple algebraic expression. Conventional methods are used to estimate surface runoff from various types of surfaces. In the analysis of vegetated roof covers, the water that is discharged from the roof is not surface runoff, but rather underflow, (i.e., percolated water). The rate and quantity of water released during a particular design storm can be predicted based on knowledge of key physical properties, including:

- Maximum media water retention
- Field capacity
- Plant cover type
- Saturated hydraulic conductivity
- Non-capillary porosity

The maximum media water retention is the maximum quantity of water that can be held against gravity under drained conditions. Standards that have been developed specifically for measuring this quantity in roof media are available from FLL and ASTM (draft).

Peak Rate Mitigation

Vegetated roof covers can exert an influence on runoff peak rates derived from roofs. A general rule is to consider the first portion of the rainfall fills the volume reduction capacity (see below).

Volume Reduction Calculations

All vegetated roof covers have both a retention and a detention volume component. Benchmarks for these volumes can be developed from the physical properties described above (*Detailed Stormwater Functions*).

The interaction of retention and detention produce both short-term effects (i.e., control of single storms) and long-term effects (i.e., reductions in total seasonal or annual roof runoff). Continuous simulation using a representative annual rainfall record from a local weather station is required in order to predict the long-term runoff versus rainfall benefit. The effectiveness of vegetated roof covers will vary according to the regional pattern of rainfall.

Using the German RWS program, the designer could generate a table of volume reductions for several regions in Pennsylvania. The table would relate the runoff ratio (runoff/rainfall) based on one or two types of cover assemblies and selected regions in PA for which good weather data is available. For the table to be used, a vegetated cover would have to comply with European guidelines.

Water Quality Improvement

Once the plant cover is established, nutrient additions should be suspended. Experience indicates that the efficiency of vegetated covers in reducing pollutant and nutrient releases from roofs will increase with time. The vegetated cover should reach its optimum performance after about five years.

See Section 8 for Water Quality Improvement methodology that addresses pollutants removal effectiveness of this BMP.



Construction Sequence

1. Visually inspect the completed waterproofing to identify any apparent flaws, irregularities, or conditions that will be interfere with the security or functionality of the vegetated covers system. The waterproofing should be tested for watertightness by the roofing applicator.
2. Institute a leak protection program
3. Introduce measures to protect the finished waterproofing from physical damage
4. Install slope stabilization measures (pitched roofs with pitches in excess of 2:12). In some installations slope stabilizing measures can be introduced as part of the roof structure and will be already be in-place at the start of the construction sequence.
5. If the waterproofing materials are not root fast, install a root-barrier layer
6. Layout key drainage and irrigation components, including drain access chambers, internal drainage conduit, confinement border units, and isolation frames (for roof-top utilities, hatches and penetrations)
7. Install walkways and paths (projects with public access)
8. Test irrigation systems (as relevant for roof gardens)
9. Install the drainage layer. Depending on the variation type, this could be a geocomposite drain, mat, or course of drainage media.
10. Cover the drainage layer with the separation fabric (in some assemblies, the separation fabric is pre-bonded to a synthetic drainage layer).

11. Install the upper growth media layer (dual media assemblies only)
12. Establish the foliage cover plantings from cuttings, seed, plugs or pre-grown mats
13. Provide protection from wind disruptions as warranted by the project conditions, and plant establishment method.

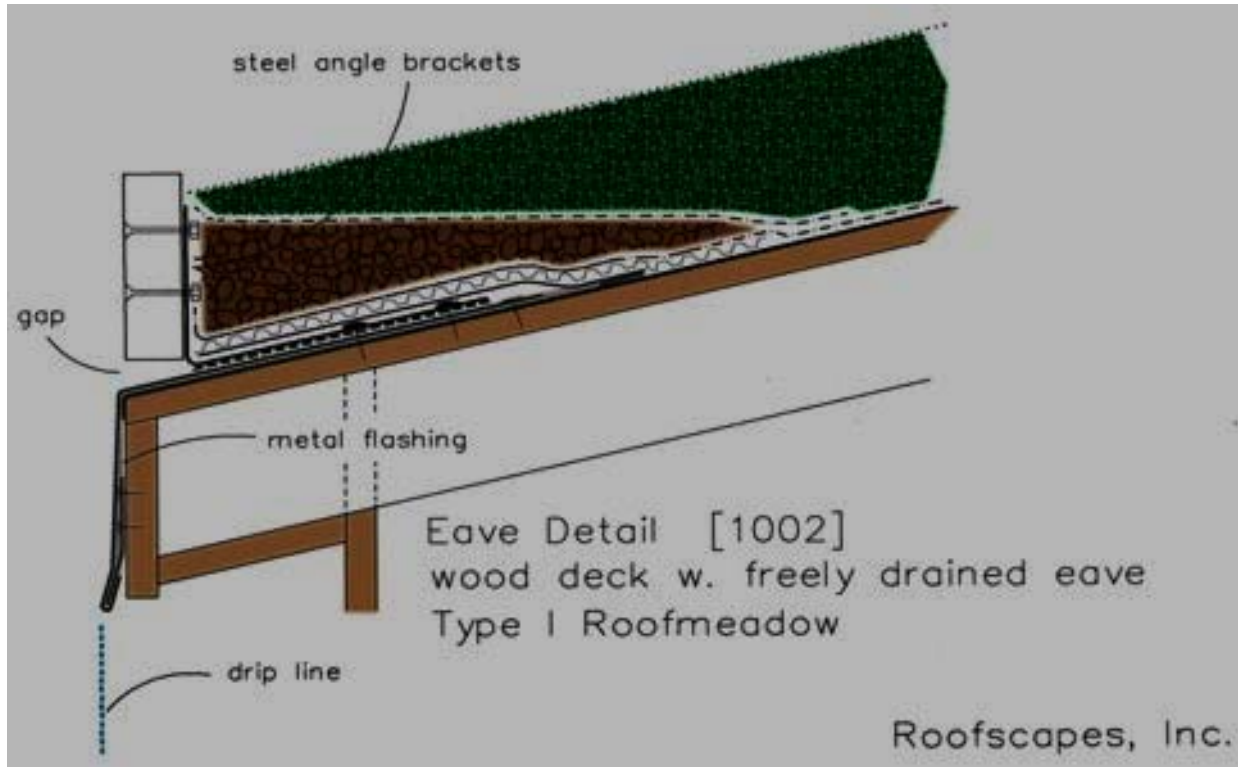

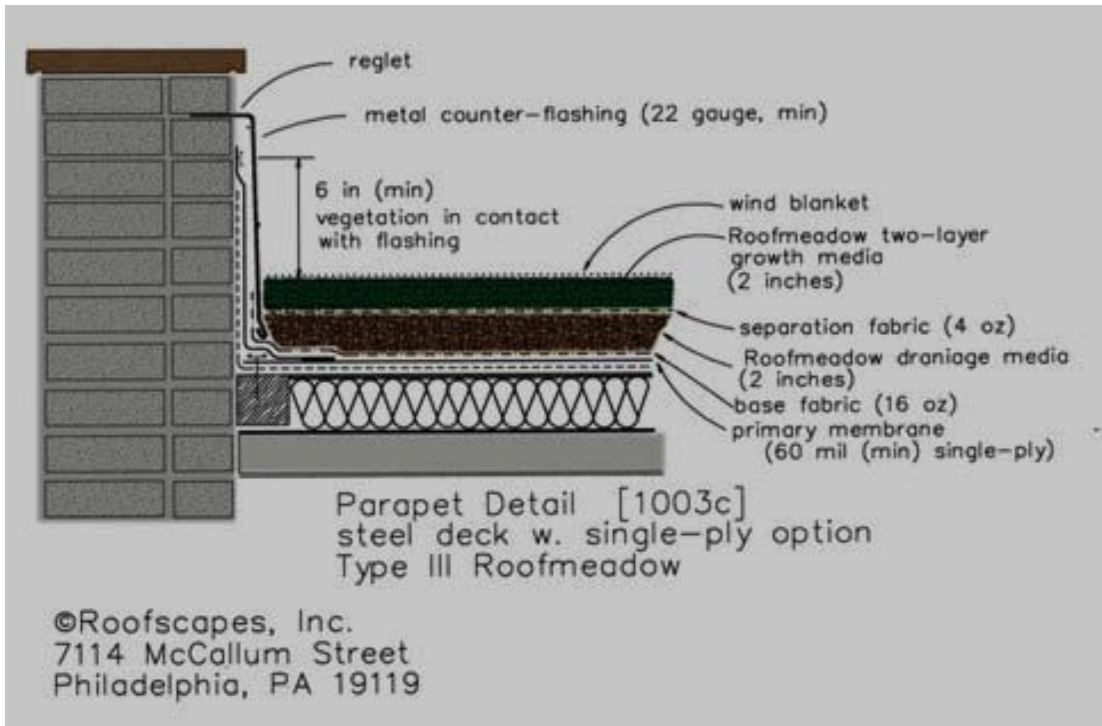

Maintenance Issues

- During the plant establishment period, periodic irrigation may be required
- During the plant establishment period, three to four visits to conduct basic weeding, fertilization, and in-fill planting is recommended. Thereafter, only two annual visits for inspection and light weeding should be needed (irrigated assemblies will require more intensive maintenance).

Cost Issues

The construction cost of vegetated roof covers can vary greatly, depending on factors such as:

- Height of the building
- Accessibility to the structure by large equipment such as cranes and trailers
- Depth and complexity of the assembly
- Remoteness of the project from sources of material supply
- Size of the project

However, under present market conditions (2004), extensive vegetated covers for roof will typically range between \$8 and \$15 per square foot, including design, installation, and warranty service. Basic maintenance for extensive vegetated covers typically requires about 3 man-hours per 1,000 square feet, annually.

Specifications

The following specifications are provided for information purposes only. These specifications include information on acceptable materials for typical applications, but are by no means exclusive or limiting. The designer is responsible for developing detailed specifications for individual design projects in accordance with the project conditions.

Due to the very large variation in assembly types and methods, it is not possible to provide a comprehensive specification. Performance specifications, describing the assembly elements and their physical properties can be obtained from commercial providers of vegetated roof covers. The references provided also offer specific guidance for the selection of materials and methods.

Some key components and associated performance-related properties are as follows:

- 1. Root-barriers** should be thermoplastic membranes with a thickness of at least 30 mils. Thermoplastic sheets can be bonded using hot-air fusion methods, rendering the seams safe from root penetration. Membranes that have been certified for use as root-barriers are recommended. At present only FLL offers a recognized test for root-barriers. Several FLL-certified materials are available in the United States. Interested American manufactures can submit products for testing to FLL-certified labs.

- 2. Granular drainage media** should be a non-carbonate mineral aggregate conforming to the following specifications:

Saturated Hydraulic Conductivity ²	25 in/min
Total Organic Matter, by Wet Combustion (MSA)	1%
Abrasion Resistance (ASTM-C131-96)	25% loss
Soundness (ASTM-C88 or T103 or T103-91)	5% loss
Porosity (ASTM-C29)	25%
Alkalinity, CaCO ₃ equivalents (MSA)	1 %
Grain-Size Distribution (ASTM-C136)	
Pct. Passing US#18 sieve	1%
Pct. Passing ¼-inch sieve	30%
Pct. Passing 3/8-inch sieve	80%

- 3. Growth media** should be a soil-like mixture containing not more than 15% organic content (wet combustion or loss on ignition methods). The appropriate grain-size distribution is essential for achieving the proper moisture content, permeability, nutrient management, and non-capillary porosity, and 'soil' structure. The grain-size guidelines vary for single and dual media vegetated cover assemblies.

Non-capillary Pore Space at Field Capacity, 0.333 bar (TMECC 03.01, A)	15% (vol)
Moisture Content at Field Capacity (TMECC 03.01, A)	12% (vol)
Maximum Media Water Retention (FLL)	30% (vol)
Alkalinity, Ca CO ₃ equivalents (MSA)	2.5%

Total Organic Matter by Wet Combustion (MSA)	3-15% (dry wt.)
pH (RCSTP)	6.5-8.0
Soluble Salts (DTPA saturated media extraction)"(RCSTP)	6 mmhos/cm
Cation exchange capacity (MSA)	10 meq/100g
Saturated Hydraulic Conductivity for Single Media Assemblies (FLL) ³	0.05 in/min
Saturated Hydraulic Conductivity for Dual Media Assemblies (FLL)	0.30 in/min
Grain-size Distribution of the Mineral Fraction (ASTM-D422)	
Single Media Assemblies	
Clay fraction (2 micron)	0
Pct. Passing US#200 sieve (i.e., silt fraction)	5%
Pct. Passing US#60 sieve	10%
Pct. Passing US#18 sieve	5 - 50%
Pct. Passing 1/8-inch sieve	20 - 70%
Pct. Passing 3/8-inch sieve	75 -100%
Dual Media Assemblies	
Clay fraction (2 micron)	0
Pct. Passing US#200 sieve (i.e., silt fraction)	5-15%
Pct. Passing US#60 sieve	10-25%
Pct. Passing US#18 sieve	20 - 50%
Pct. Passing 1/8-inch sieve	55 - 95%
Pct. Passing 3/8-inch sieve	90 -100%

Macro- and micro-nutrients shall be incorporated in the formulation in initial proportions suitable for support the specified planting.

4. **Separation fabric** should be readily penetrated by roots, but provide a durable separation between the drainage and growth media layers (Only lightweight nonwoven geotextiles are recommended for this function.

Unit Weight (ASTM-D3776)	4.25 oz/yd ²
Grab tensile (ASTM-D4632)	90 lb
Mullen Burst Strength (ASTM-D4632)	135 lb/in
Permittivity (ASTM-D4491)	2 sec-1

References

FLL: Guidelines for the Planning, Installation, and Maintenance in Roof Greening, 1995, English Version (*Richtlinien für die Planung, Ausführung und Pflege von Dachbegrünungen*), Forschungsgesellschaft Landschaftsentwicklung Landschaftsbau e.V.

ASTM: American Standard Testing Methods

Planting Green Roofs and Living Walls, 2004, Dunnett, N, and Kingsbury, N, Timber Press [ISBN 0-88192-640-X]

Penn State Center For Green Roof Research, <http://hortweb.cas.psu.edu/research/greenroofcenter/>

FOOTNOTES

- ¹ FLL or ASTM procedures for determining the maximum density and associated moisture content under compressed and hydrated conditions. See ASTM Draft: Standard Test Method for Maximum Media Density for Dead Load Analysis of Green Roof Systems , and ASTM Draft Standard Practice for Determination of Dead Loads and Live Loads for Green Roof Systems
- ² ASTM Draft: Standard Test Method for Saturated Hydraulic Conductivity of Granular Drainage Media [Falling-Head Method] for Green Roof Systems

BMP 6.5.2: Runoff Capture & Reuse



Capture and Reuse encompasses a wide variety of water storage techniques designed to “capture” precipitation, hold it for a period of time, and reuse the water. Heavy rainfall may require slow release over time. A water budget must be developed to ensure that the water will be used to allow for more runoff capture

<p style="text-align: center;"><u>Key Design Elements</u></p> <ul style="list-style-type: none"> ▪ Storage techniques may include cisterns, underground tanks, above-ground vertical storage tanks, rain barrels or other systems ▪ Storage devices designed to capture a portion of the small, frequent storm events ▪ Most effective when designed to meet a specific water need for reuse ▪ Systems must for bypass or overflow of large storm events ▪ Water budget analysis incorporating anticipated water inflow and usage is required ▪ Collection and placement of storage elements up gradient of areas of reuse may reduce or eliminate pumping needs Maintenance - periodic tank and sump cleanout is required 	<p style="text-align: center;"><u>Potential Applications</u></p> <p style="text-align: center;">Residential: Yes Commercial: Yes Ultra Urban: Yes Industrial: Yes Retrofit: Yes Highway/Road: Limited</p> <hr/> <p style="text-align: center;"><u>Stormwater Functions</u></p> <p>Volume Reduction: Med/High Recharge: Low Low Peak Rate Control: Medium Water Quality: Medium</p> <hr/> <p style="text-align: center;"><u>Water Quality Functions</u></p> <p style="text-align: center;">TSS: 100% TP: 100% NO3: 100%</p>
---	---

Description

Cisterns, Rain Barrels, Vertical Storage, and similar devices have been used for centuries to capture storm water from the roofs of buildings, and in many parts of the world these systems serve as a primary water supply source. The reuse of stormwater for potable needs is not advised without water treatment, although many homes in the U.S. were storing water in cisterns for reuse as little as a century ago. These systems can reduce potable water needs for uses such as irrigation and fire protection while also reducing stormwater discharges.

Storage/reuse techniques range from small, residential systems such as Rain Barrels that are maintained by the homeowner to supplement garden needs, to large, “vertical storage” units that can provide firefighting needs. Storage/reuse techniques are useful in urban areas where there is little physical space to manage storm water.

Variations

Cisterns – large, underground or surface containers designed to hold large volumes of water (500 gallons or more). Cisterns may be comprised of fiberglass, concrete, plastic, brick or other materials.



Rain barrels – barrel (or large container) that collect drainage from roof leaders and store water until needed for irrigation.



Vertical Storage – stand along “towers”, or “fat downspouts” that usually rest against a building performing the same capture, storage and release functions as cisterns and rain barrels.

Storage Beneath Structure – Storage may be incorporated into elements such as paths and walkways to supplement irrigation with the use of structural plastic storage units

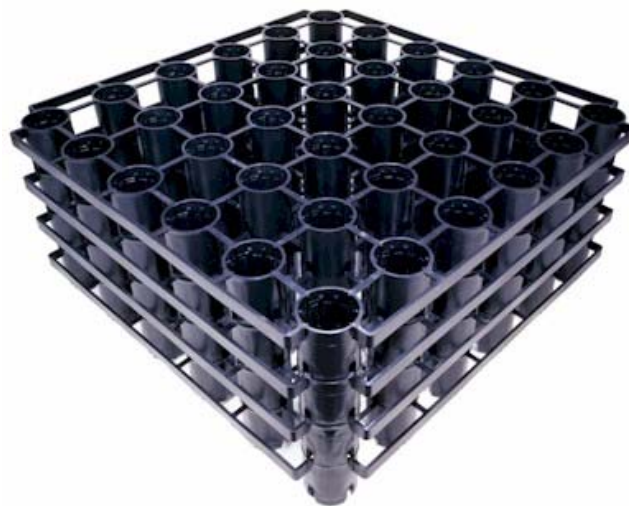
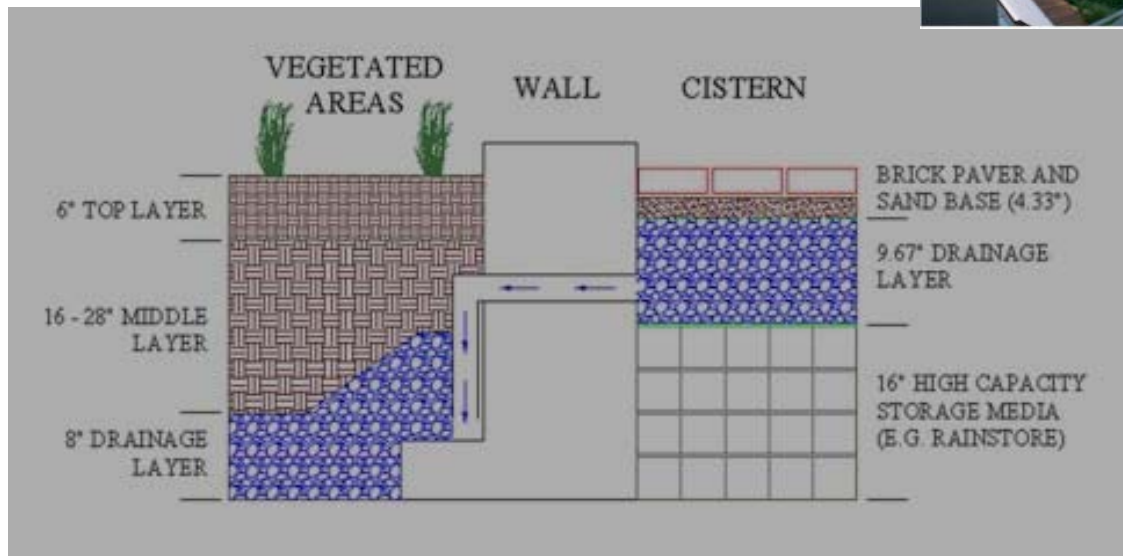

Applications

- Landscaped areas and gardens to meet irrigation needs
- Storage for firefighting needs
- Urban areas and Combined Sewer areas to reduce peak surcharges.
- Reuse for greywater needs such as flushing toilets.
- Reuse for athletic field irrigation

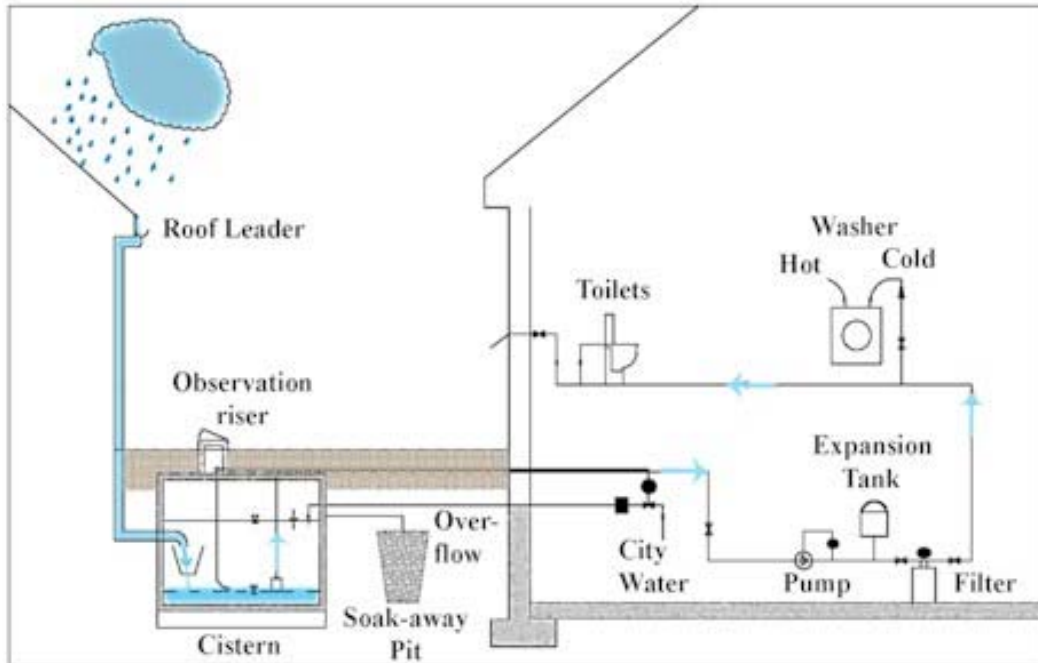

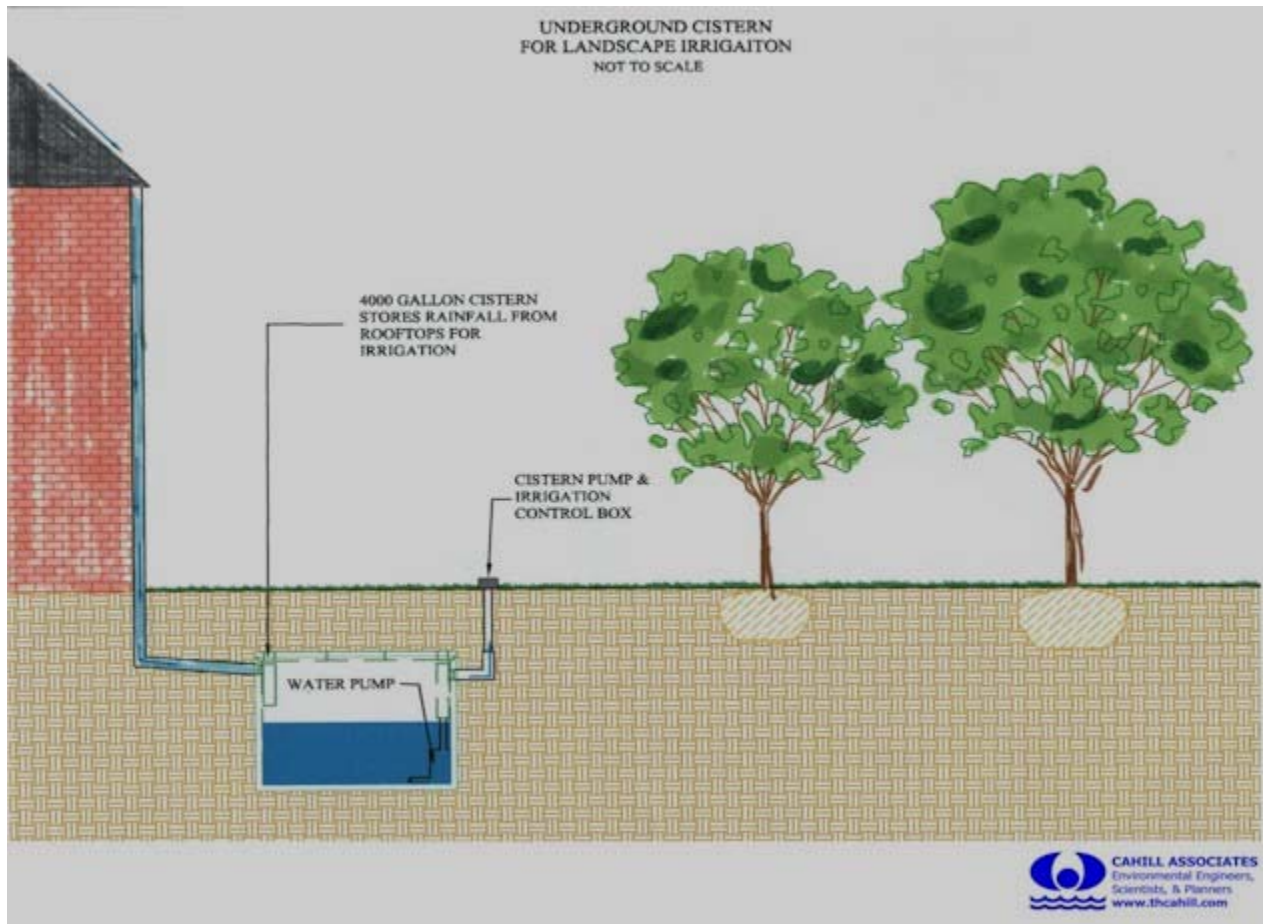

Design Considerations

1. The Designer should **calculate the water need** for the intended uses. For example, what will the collected water be used for and when will it be needed? If a 2,000 square foot area of lawn requires irrigation for 4 months in the summer at a rate of 1” per week, how much will be needed and how often will the storage unit be refilled? The usage requirements and the expected rainfall volume and frequency should be determined.
2. **Drawdown** – the Designer should provide for use or release of the stored water between storm events in order for the necessary stormwater storage volume to be available.
3. The **Catchment Area** on which the rain falls should be considered. The catchment area typically handles roof runoff.
4. The **Conveyance System** should keep reused stormwater or greywater from other potable water piping systems. Do not connect to domestic or commercial potable water system.
5. Pipes or storage units should be clearly marked “Caution: Reclaimed water, Do Not Drink”.
6. Screens may be used to filter debris from storage units.

7. The **first flush** runoff may be diverted away from storage in order to minimize sediment and pollutant entry. However, rooftop runoff contains very low concentrations of pollutants.
8. Storage elements should be protected from direct sunlight by positioning and landscaping. (Limit light into devices to minimize algae growth.)
9. The proximity to building foundations should be considered for overflow conditions.
10. Climate is an important consideration, and capture/reuse systems should be designed to account for the potential of freezing.
11. Cisterns should be watertight (joints sealed with nontoxic waterproof material) with a smooth interior surface, and capable of receiving water from rainwater harvesting system.
12. Covers (lids) should have a tight fit to keep out surface water, animals, dust and light.
13. Positive outlet for overflow should be provided a few inches from the top of the cistern.
14. Observation risers should be at least 6" above grade for buried cisterns.
15. Reuse may require pressurization. Water stored has a pressure of 0.43 psi per foot of water elevation. A ten-foot tank would have a pressure of $0.43 \times 10 = 4.3$ psi. at the bottom of the tank. Most irrigation systems require at least 15 psi. To add pressure, a pump, pressure tank and fine mesh filter can be used, which adds to the cost of the system, but creates a more usable system.

Capacities of Various sized Cisterns (cf)							
Depth (ft)	Diameter of Round Types (ft)						
	6	8	10	12	14	16	18
6	1266	2256	3522	5076	6906	9018	11412
8	1688	3008	4696	6768	9208	12024	15216
10	2110	3760	5870	8460	11510	15030	19020
12	2532	4512	7044	8532	13812	18036	22824
14	2954	5264	8218	11844	16114	21042	26628
* Harvested Rainwater Guidelines, GreenBuilder.com							

Annual Rainfall Yield in Gallons for Various Impervious Surface Sizes and Rainfall Amounts									
Impervious Surface Area sf	Rainfall (inches)								
	20	24	28	32	36	40	44	48	52
1000	11844	14213	16582	18951	21319	23688	26057	28426	30795
1100	13029	15634	18240	20846	23451	26057	28663	31268	33874
1200	14213	17056	19898	22741	25583	28426	31268	34111	36954
1300	15397	18477	21556	24636	27715	30795	33874	36954	40033
1400	16582	19898	23214	26531	29847	33164	36480	39796	43113
1500	17766	21319	24873	28426	31979	35532	39086	42639	46192
1600	18951	22741	26531	30321	34111	37901	41691	45481	49272
1700	20135	24162	28189	32216	36243	40270	44297	48324	52351
1800	21319	25583	29847	34111	38375	42639	46903	51167	55431
1900	22504	27005	31505	36006	40507	45008	49508	54009	58510
2000	23688	28426	33164	37901	42639	47377	52114	56852	61589
2100	24873	29847	34822	39796	44771	49745	54720	59694	64669
2200	26057	31268	36480	41691	46903	52114	57326	62537	67748
2300	27241	32690	38138	43586	49035	54483	59931	65380	70828
2400	28426	34111	39796	45481	51167	56852	62537	68222	73907
2500	29610	35532	41454	47377	53299	59221	65143	71065	76987
2600	30795	36954	43113	49272	55431	61589	67748	73907	80066
2700	31979	38375	44771	51167	57562	63958	70354	76750	83146
2800	33164	39796	46429	53062	59694	66327	72960	79593	86225

* Values represent 95% of actual precipitation to account for any storage and/or losses.

Detailed Stormwater Functions

Volume Reduction Calculations

Volume reduction is the actual volume of the storage container, taking into consideration how many times it is emptied.

Peak Rate Mitigation Calculations:

Capture and reuse takes a volume of water out of site runoff. This reduction in volume will translate to a lower overall peak rate for the site.

Water Quality Improvement

Pollutant removal takes place through filtration of recycled primary storage, and/or natural filtration through soil and vegetation for overflow discharge. Quantifying pollutant removal will depend on design. Sediment removal will depend on area below outlet that is designed for sediment accumulation, time in storage, and maintenance frequency. Filtration through soil will depend on flow rate, the type of soil (infiltration capacity), and design specifics (stone bed, etc.).

Construction Sequence

Install per manufacturer’s instructions.

Maintenance Issues

Flush cisterns to remove sediment. Brush the inside surfaces and thoroughly disinfect.

Winter concern: Do not allow water to freeze in devices. (Empty out before water freezes.)

Cost Issues

Rain Barrel: ranges from \$80 to \$200, average for residential use is \$150 (2005)

Cistern: varies, depending on material used (reinforced concrete, steel, plastic are common), size, and pump characteristics

Vertical Storage: ranges from \$88 for 64-gallon capacity to \$10,516 for 12,000-gallon capacity (for a plastic, manufactured product). Storage costs \$1.25/gallon (2005).

General: the reuse of water for irrigation or other uses saves money on water costs over time.

Specifications:

The following specifications are provided for informational purposes only. These specifications include information on acceptable materials for typical applications, but are by no means exclusive or limiting. The designer is responsible for developing detailed specifications for individual design projects in accordance with the project conditions.

1. **Vertical Storage** All storage containers should meet FDA specifications for stored drinking water if potable water is the intended use. Follow Manufacturer's specifications for vertical storage containers.

References

City of Tucson, Water Harvesting Guidance Manual, March 2003 (edited by Ann Audrey Phillips, prepared for the City of Tucson, Department of Transportation, Stormwater Section)

“What are Rainwater Harvesting and Stormwater Recycling?” Heather Kinkade-Levario, ASLA and Hari Krishna Ph.D., P.E., Ann Phillips, Tim Pope

Sustainable Building Sourcebook, “Harvested Rainwater Guidelines”, sections 1.0, 2.0, 3.0
www.greenbuilder.com

“Rainwater Harvesting” www.ci.austin.tx.us/greenbuilder/fs_rainharvest.htm City of Austin, TX

Portland, OR’s Code Guide Office of Planning & Development Review “Rainwater Harvesting – ICC – RES/34/#1 & UPC/6/#2, March 2001

U.S. EPA National Pollutant Discharge Elimination System, “Post-Construction Storm Water Management in New Development & Redevelopment, On-Lot Treatment”

City of Vancouver, Engineering Services, Water and Sewers “Rain Barrel Program”

“Cisterns/Rainwater Harvesting Systems, www.advancedbuildings.org Technologies and Practices, Plumbing & Water Heating

CSIRO, Land and Water, “Urban Water Reuse – Frequently Asked Questions” (south Australia)

“Rain Barrels – Truth or Consequences” Karen Sands, AICP and Thomas Chapman, P.E., Milwaukee Metropolitan Sewerage District, Milwaukee, Wisconsin

“Hydrologic Processes at the Residential Scale” Qingfu Xiao, E. Gregory McPherson, James R. Simpson, Hydrologic Sciences Program, UC Davis, Center for Urban Forest Research, USDA Forest Service

“Black Vertical Storage Tanks by Norwesco” www.precisionpump.net/storagetanksystems.htm

6.6 Runoff Quality/Peak Rate BMPs

BMP 6.6.1: Constructed Wetland



Constructed Wetlands are shallow marsh systems planted with emergent vegetation that are designed to treat stormwater runoff.

<p style="text-align: center;"><u>Key Design Elements</u></p> <ul style="list-style-type: none"> ▪ Adequate drainage area (usually 5 to 10 acres minimum) or proof of sustained base flow May require investigation of water supply to ensure a sustained baseflow to maintain the wetland ▪ Maintenance of permanent water surface ▪ Multiple vegetative growth zones through varying depths ▪ Robust and diverse vegetation ▪ Relatively impermeable soils or engineered liner ▪ Sediment collection and removal ▪ Adjustable permanent pool and dewatering mechanism Maintenance - periodic sediment removal from the forebay and vegetation maintenance 	<p style="text-align: center;"><u>Potential Applications</u></p> <p style="text-align: center;">Residential: Yes Commercial: Yes Ultra Urban: Limited Industrial: Yes Retrofit: Yes Highway/Road: Yes</p>
	<p style="text-align: center;"><u>Stormwater Functions</u></p> <p style="text-align: center;">Volume Reduction: Low Recharge: Low Peak Rate Control: High Water Quality: High</p>
	<p style="text-align: center;"><u>Water Quality Functions</u></p> <p style="text-align: center;">TSS: 85% TP: 85% NO3: 30%</p>

Description

Constructed Wetlands are shallow marsh systems planted with emergent vegetation that are designed to treat stormwater runoff. While they are one of the best BMPs for pollutant removal, Constructed Wetlands (CWs) can also mitigate peak rates and even reduce runoff volume to a certain degree. They also can provide considerable aesthetic and wildlife benefits. CWs use a relatively large amount of space and require an adequate source of inflow to maintain the permanent water surface.

Variations

Constructed Wetlands can be designed as either an online or offline facilities. They can also be used effectively in series with other flow/sediment reducing BMPs that reduce the sediment load and equalize incoming flows to the CWs. Constructed Wetlands are a good option for retrofitting existing detention basins. CWs are often organized into four groups:

- Shallow Wetlands are large surface area CWs that primarily accomplish water quality improvement through displacement of the permanent pool.
- Extended Detention Shallow Wetlands are similar to Shallow Wetlands but use extended detention as another mechanism for water quality and peak rate control.
- Pocket Wetlands are smaller CWs that serve drainage areas between approximately 5 and 10 acres and are constructed near the water table.
- Pond/Wetland systems are a combination of a wet pond and a constructed wetland.

Although this BMP focuses on surface flow Constructed Wetlands as described above, subsurface flow CWs can also be used to treat stormwater runoff. While typically used for wastewater treatment, subsurface flow CWs for stormwater may offer some advantages over surface flow wetlands, such as improved reduction of total suspended solids and oxygen demand. They also can reduce the risk of vectors (especially mosquitoes) and safety risks associated with open water. However, nitrogen removal may be deficient (Campbell and Ogden, 1999). Perhaps the biggest disadvantage is the relatively low treatment capacities of subsurface flow CWs – they are generally only able to treat small flows. For more information, please consult the “References and Additional Resources” list.

Applications

- **Alternating bands of deeper water and shallow marsh.**

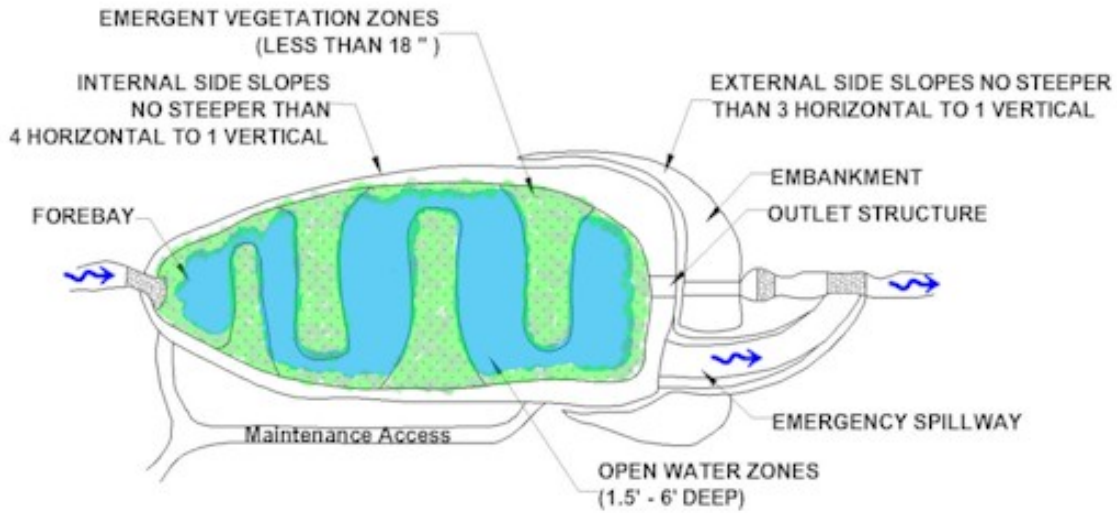

- **Wet Pond/Wetland System**

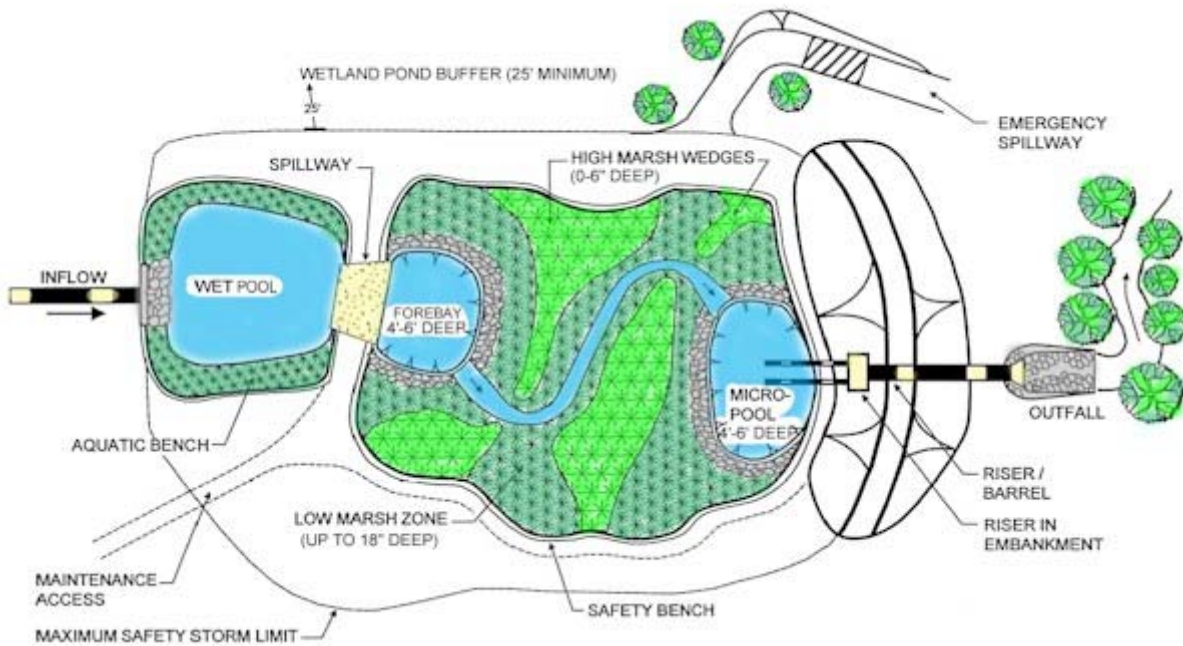

- **Pocket Wetland**

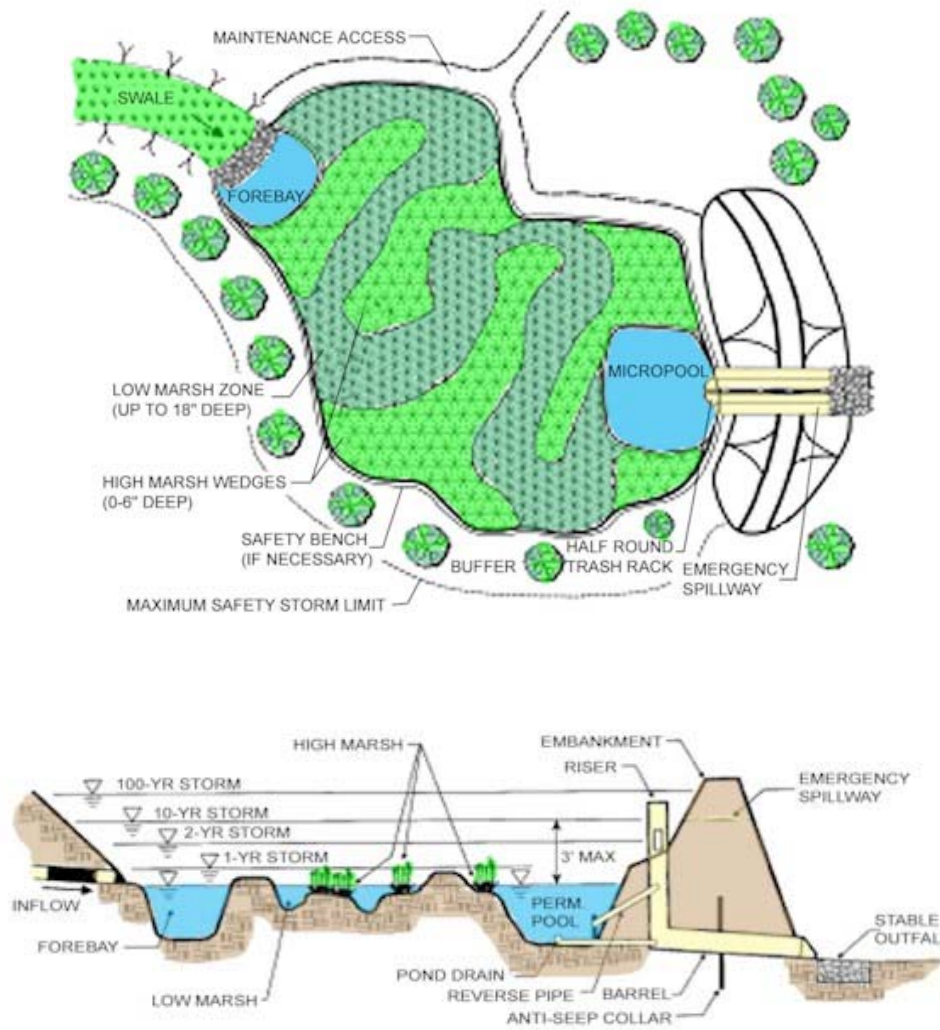

- **Offline Constructed Wetland**
- **Retrofit of existing detention basins**



Design Considerations

1. **HYDROLOGY.** Constructed Wetlands must be able to receive and retain enough flow from rain, runoff, and groundwater to ensure long-term viability. Hydrologic calculations (or a water balance) should be performed to verify this. Shallow marsh areas can become dry at the surface but not for greater than one month, even in the most severe drought. A permanent water surface in the deeper areas of the CWs should be maintained during all but the driest periods. A relatively stable normal water surface elevation will reduce the stress on wetland vegetation. A CWs must have a drainage area of at least 10 acres (5 acres for “pocket” wetlands) or some means of sustaining constant inflow. Even with a large drainage area, a constant source of inflow can improve the biological health and effectiveness of a Constructed Wetland. Pennsylvania’s precipitation is generally well distributed throughout the year and is therefore suited for CWs.
2. **UNDERLYING SOILS.** Underlying soils must be identified and tested. Generally hydrologic soil groups “C” and “D” are suitable without modification, “A” and “B” soils may require a clay or synthetic liner. Soil permeability must be tested in the proposed Constructed Wetland location to ensure that excessive infiltration will not cause the CWs to dry out. If necessary, CWs should have a highly- compacted subsoil or an impermeable liner to minimize infiltration.
3. **PLANTING SOIL.** Organic soils should be used for Constructed Wetlands. Organic soils can serve as a sink for pollutants and generally have high water holding capacities. They will also facilitate plant growth and propagation and may hinder invasion of undesirable species.
4. **SIZE AND VOLUME.** The area required for a CWs is generally 3 to 5 percent of its drainage area. CWs should be sized to treat the water quality volume and, if necessary, to mitigate the peak rates for larger events.
5. **VEGETATION.** Vegetation is an integral part of a Wetland system. Vegetation may help to reduce flow velocities, promote settling, provide growth surfaces for beneficial microbes, uptake pollutants, prevent resuspension, provide filtering, limit erosion, prevent short-circuiting, and maintain healthy bottom sediments (Braskerud, 2001). Constructed Wetlands should have several different zones of vegetation as described in Table 6.6.1-1. The emergent vegetation zone (areas not more than 18” deep) should comprise about 60 to 65 percent of the normal water surface area, although recommendations in recent literature range from less than 50 to over 80 percent. Robust, non-invasive, perennial plants that establish quickly are ideal for CWs. The designer should select species that are tolerant of a range of depths, inundation periods, etc. Monoculture planting must be avoided due to the risk from pests and disease. Use local recommended plant lists.

Table 6.6.1-1

Vegetation Zone	Description
Open Water	Areas between 18 inches and 6 feet deep
Emergent	Areas up to 18 inches deep
Low Marsh	Portion of Emergent Zone between 6 and 18 inches deep
High Marsh	Portion of Emergent Zone up to 6 inches deep
Ephemeral Storage	Area periodically inundated during runoff events
Buffer	Area outside of maximum water surface elevation



6. CONFIGURATION.

- a. General. Constructed Wetlands should be designed with a length to width ratio of at least 2:1 wherever possible. If the length to width ratio is lower, the flow pathway through the CWs should be maximized. CWs should not be constructed within 10 feet of the property line or within 50 feet of a private well or septic system. CWs should be designed so that the 10-year water surface elevation does not exceed the normal water surface elevation by more than 3 feet. Slopes in and around Constructed Wetlands should be 4:1 to 5:1 (H:V) wherever possible. Constructed wetlands should be located outside of any natural watercourse.
- b. Forebay/Inflows. Constructed Wetlands should have a forebay at all major inflow points to capture coarse sediment, prevent excessive sediment accumulation in the remainder of the CWs, and minimize erosion by inflow. The forebays should contain 10 to 15 percent of the total permanent pool volume and should be 4 to 6 feet deep (at least as deep as other open water areas). They should be physically separated from the rest of the wetland by a berm, gabion wall, etc. Flows exiting the forebay should be non-erosive to the newly constructed CWs. Vegetation within forebays can increase sedimentation and reduce resuspension/erosion. The forebay bottom can be hardened to facilitate sediment removal. Forebays should be installed with permanent vertical markers that indicate sediment depth. Inflow channels should be fully stabilized. Inflow pipes can discharge to the surface or be partially submerged. CWs should be protected from the erosive force of the inflow to prevent the resuspension of previously collected sediment during large flows.



- c. Vegetation and Open Water Zones. About half of the emergent vegetation zone should be high marsh (up to 6" deep) and half should be low marsh (6" to 18" deep). Varying depths throughout the CWs can improve plant diversity and health. The open water zone (approx. 35 to 40% of the total surface area) should be between 18 inches and 6 feet deep. Allowing a limited 5-foot deep area can prevent short-circuiting by encouraging mixing, enhance aeration of water, prevent resuspension, minimize thermal

- impacts, and limit mosquito growth. Alternating areas of emergent vegetation zone (up to 18 inches deep) and open water zone – as shown in Figures 6.13-2 and 6.13-4 – can also minimize short-circuiting and hinder mosquito propagation.
- d. **Outlet.** Outlet control devices should be in open water areas 4 to 6 feet deep comprising about 5 percent of the total surface area to prevent clogging and allow the CWs to be drained for maintenance. Outlet devices are generally multistage structures with pipes, orifices, or weirs for flow control. Orifices should be at least 2.5 inches in diameter and should be protected from clogging. Outlet devices should be installed in the embankment for accessibility. It is recommended that outlet devices enable the normal water surface to be varied. This allows the water level to be adjusted (if necessary) seasonally, as the CWs accumulates sediment over time, if desired grades are not achieved, or for mosquito control. The outlet pipe should generally be fitted with an anti-seep collar. Online facilities should have an emergency spillway that can safely pass the 100-year storm with 1 foot of freeboard. All outflows should be conveyed downstream in a safe and stable manner.
 - e. **Safety Benches.** All areas that are deeper than 4 feet should have two safety benches, each 4 to 6 feet wide. One should be situated about 1 to 1.5 feet above the normal water elevation and the other 2 to 2.5 feet below the water surface.
7. **CONSTRUCTED WETLAND BUFFER.** To enhance habitat value, visual aesthetics, and wetland health, a 25-foot buffer should be added from the maximum water surface elevation. The buffer should be planted with trees, shrubs, and native ground covers. Existing trees within the buffer should be preserved. If soils in the buffer will become compacted during construction, soil restoration should take place to aid buffer vegetation.
 8. **MAINTENANCE ACCESS.** Permanent access must be provided to the forebay, outlet, and embankment areas. It should be at least 9 feet wide, have a maximum slope of 15%, and be stabilized for vehicles.
 9. **PLAN ELEMENTS.** The plans detailing the Constructed Wetlands should clearly show the CWs configuration, elevations and grades, depth/vegetation zones, and the location, quantity, and propagation methods of wetland/buffer vegetation. Plans should also include site preparation techniques, construction sequence, as well as maintenance schedules and requirements.
 10. **REGULATION.** Constructed Wetlands that have drainage areas over 100 acres, embankments greater than 15 feet high, or a capacity greater than 50 acre-feet may be regulated as a dam by PADEP (see Title 25, Chapter 105 of the Pennsylvania Code).

Detailed Stormwater Functions

Volume Reduction Calculations

Although not typically considered a volume-reducing BMP, Constructed Wetlands can achieve some volume reduction through evapotranspiration, especially during small storms. An evapotranspiration study could be done to account for potential volume reduction credit. Hydrologic calculations that should be performed to verify that the CWs will have a viable amount of inflow can also predict the water surface elevation under varying conditions. The volume stored between the predicted water level and the lowest outlet elevation will be removed from the storm that occurs under those conditions.

Peak Rate Mitigation Calculations

Peak rate is primarily controlled in Constructed Wetlands through the transient storage above the normal water surface. See in Section 8 for Peak Rate Mitigation methodology.

Water Quality Improvement

Constructed Wetlands improve runoff quality through settling, filtration, uptake, chemical and biological decomposition, volatilization, and adsorption. Constructed Wetlands are effective at removing many common stormwater pollutants including suspended solids, heavy metals, total phosphorus, total nitrogen, toxic organics, and petroleum products. The pollutant removal effectiveness varies by season and may be affected by the age of the wetland. It has been suggested that Constructed wetlands do not remove nutrients in the long term unless vegetation is harvested because captured nutrients are released back into the water by decaying plant material. Even if this is true, nutrients are generally released gradually and during the non-growing season when downstream susceptibility is generally low (Hammer, 1990). See in Section 8 for Water Quality Improvement methodology which addresses pollutant removal effectiveness of this BMP.

Construction Sequence

1. Separate wetland area from contributing drainage area:
 - a. All channels/pipes conveying flows to the Constructed Wetland must be routed away from the wetland area until it is completed and stabilized.
 - b. The area immediately adjacent to the Constructed Wetland must be stabilized in accordance with the PADEP's Erosion and Sediment Pollution Control Program Manual (2000 or latest edition) prior to construction of the wetland.
2. Clearing and Grubbing:
 - a. Clear the area to be excavated of all vegetation.
 - b. Remove all tree roots, rocks, and boulders.
 - c. Fill all stump holes, crevices and similar areas with impermeable materials.
3. Excavate bottom of Constructed Wetland to desired elevation (Rough Grading).
4. Install surrounding embankments and inlet and outlet control structures.
5. Grade and compact subsoil.
6. Apply and grade planting soil.
 - a. Matching design grades is crucial because aquatic plants can be very sensitive to depth.
7. Apply geo-textiles and other erosion-control measures.
8. Seed, plant and mulch according to Planting Plan
9. Install any anti-grazing measures, if necessary.
10. Follow required maintenance and monitoring guidelines.



Maintenance Issues

Constructed Wetlands must have a maintenance plan and privately owned facilities should have an easement, deed restriction, or other legal measure to prevent neglect or removal. During the first growing season, vegetation should be inspected every 2 to 3 weeks. During the first 2 years, CWs should be inspected at least 4 times per year and after major storms (greater than 2 inches in 24 hours). Inspections should assess the vegetation, erosion, flow channelization, bank stability, inlet/outlet conditions, and sediment/debris accumulation. Problems should be corrected as soon as possible. Wetland and buffer vegetation may require support – watering, weeding, mulching, replanting, etc. – during the first 3 years. Undesirable species should be removed and desirable replacements planted if necessary.

Once established, properly designed and installed Constructed Wetlands should require little maintenance. They should be inspected at least semiannually and after major storms as well as rapid ice breakup. Vegetation should maintain at least an 85 percent cover of the emergent vegetation zone. Annual harvesting of vegetation may increase the nutrient removal of CWs; it should generally be done in the summer so that there is adequate regrowth before winter. Care should be taken to minimize disturbance, especially of bottom sediments, during harvesting. The potential disturbance from harvesting may outweigh its benefits unless the CWs receives a particularly high nutrient load or discharges to a nutrient sensitive waterbody. Sediment should be removed from the forebay before it occupies 50 percent of the forebay, typically every 3 to 7 years.

Cost Issues

The construction cost of Constructed Wetlands can vary greatly depending on the configuration, location, site-specific conditions, etc. Typical construction costs in 2004 dollars range from approximately \$30,000 to \$65,000 per acre (USEPA Wetlands Fact Sheet, 1999). Costs are generally most dependent on the amount of earthwork and the planting. Annual maintenance costs have been reported to be approximately 2 to 5 percent of the capital costs although there is very little data available to support this.

Specifications:

The following specifications are provided for information purposes only. These specifications include information on acceptable materials for typical applications, but are by no means exclusive or limiting.

The designer is responsible for developing detailed specifications for individual design projects in accordance with the project conditions.

1. **Excavation**

- a. The area to be used for the CWs should be excavated to the required depth below the desired bottom elevation to accommodate any required impermeable liner, organic matter, and/or planting soil.
- b. The compaction of the subgrade and/or the installation of any impermeable liners will follow immediately.

2. **Subsoil Preparation**

- a. Subsoil shall be free from hard clods, stiff clay, hardpan, ashes, slag, construction debris, petroleum hydrocarbons, or other undesirable material. Subsoil must not be delivered in a frozen or muddy state.
- b. Scarify the subsoil to a depth of 8 to 10 inches with a disk, rototiller, or similar equipment.
- c. Roll the subsoil under optimum moisture conditions to a dense seal layer with four to six passes of a sheepfoot roller or equivalent. The compacted seal layer shall be at least 8 inches thick.

3. **Impermeable Liner**

- a. If necessary, install impermeable liner in accordance with manufacturer's guidelines.
- b. Place a minimum 12 inches of subsoil on top of impermeable liner in addition to planting soil.

4. **Planting Soil (Topsoil)**

- a. See Local Specifications for general Planting Soil requirements.
- b. Use a minimum of 12 inches of topsoil in marsh areas of the Wetland. If natural topsoil from the site is to be used it must have at least 8 percent organic carbon content (by weight) in the A-horizon for sandy soils and 12% for other soil types.
- c. If planting soil is being imported it should be made up of equivalent proportions of organic and mineral materials.
- d. Lime should not be added to planting soil unless absolutely necessary as it may encourage the propagation of invasive species.
- e. The final elevations and hydrology of the wetland zones should be evaluated prior to planting to determine if grading or planting changes are required.

5. **Vegetation**

- a. Plant Lists for Constructed Wetlands can be found in Appendix B. No substitutions of specified plants will be accepted without prior approval of the designer. Planting locations shall be based on the Planting Plan and directed in the field by a qualified wetland ecologist.
- b. All wetland plant stock shall exhibit live buds or shoots. All plant stock shall be turgid, firm, and resilient. Internodes of rhizomes may be flexible and not necessarily rigid. Soft or mushy stock shall be rejected. The stock shall be free of deleterious insect infestation, disease and defects such as knots, sun-scald, injuries, abrasions, or disfigurement that could adversely affect the survival or performance of the plants.
- c. All stock shall be free from invasive or nuisance plants or seeds such as those listed in Appendix B.
- d. During all phases of the work, including transport and onsite handling, the plant materials shall be carefully handled and packed to prevent injuries and desiccation. During transit and onsite handling, the plant material shall be kept from freezing and shall be kept covered, moist, cool, out of the weather, and out of the wind and sun. Plants shall be watered to maintain moist soil and/or plant conditions until accepted.
- e. Plants not meeting these specifications or damaged during handling, loading, and unloading will be rejected.

f. Detailed planting specifications can be found in Appendix B.

6. **Outlet Control Structure**

- a. Outlet control structures shall be constructed of non-corrodible material.
- b. Outlets shall be resistant to clogging by debris, sediment, floatables, plant material, or ice.
- c. Materials shall comply with applicable specifications (PennDOT or AASHTO, latest edition)

References

Auckland Regional Council, 2003. *Stormwater Management Devices: Design Guidelines Manual*, Auckland, New Zealand

Braskerud, B.C. "Influence of Vegetation on Sedimentation and Resuspension of Soil Particles in Small Constructed Wetlands," *Journal of Environmental Quality*, Vol. 30: pp. 1447-1457, 2001.

California Stormwater Quality Association, 2003. *California Stormwater Best Management Practices Handbook: New Development and Redevelopment*.

Campbell, C. and Ogden, M. *Constructed Wetlands in the Sustainable Landscape*. John Wiley & Sons Inc., 1999.

Caraco, D. and Claytor, R. *Stormwater BMP Design Supplement for Cold Climates*. 1997. USEPA BMP Fact Sheet

Atlanta Regional Commission. *Georgia Stormwater Management Manual*. 2004.

Hammer, D. (Editor). *Constructed Wetlands for Wastewater Treatment*. Lewis Publishers, 1990.

Center for Watershed Protection and Maryland Department of the Environment, 2000. *2000 Maryland Stormwater Design Manual*, Baltimore, MD

University of California: Division of Agriculture and Natural Resources. *Managing Mosquitos in Surface Flow Constructed Treatment Wetlands*. 1998.

New Jersey Department of Environmental Protection, 2004. *New Jersey Stormwater Best Management Practices Manual*.

Pennsylvania Department of Environmental Protection, 2000. *Erosion and Sediment Pollution Control Program Manual*.

City of Portland Environmental Services, 2002. *City of Portland Stormwater Management Manual: Revision #2*.

Wetlands: Characteristics and Boundaries. Committee on Characterization of Wetlands, National Research Council (1995)

BMP 6.6.2: Wet Pond/Retention Basin



Wet Ponds/Retention Basins are stormwater basins that include a substantial permanent pool for water quality treatment and additional capacity above the permanent pool for temporary runoff storage.

<p style="text-align: center;"><u>Key Design Elements</u></p> <ul style="list-style-type: none"> ▪ Adequate drainage area (usually 5 to 10 acres minimum) or proof of sustained baseflow ▪ Natural high groundwater table ▪ Maintenance of permanent water surface ▪ Should have at least 2 to 1 length to width ratio ▪ Robust and diverse vegetation surrounding wet pond ▪ Relatively impermeable soils ▪ Forebay for sediment collection and removal ▪ Dewatering mechanism 	<p style="text-align: center;"><u>Potential Applications</u></p> <p>Residential: Yes Commercial: Yes Ultra Urban: Yes Industrial: Yes Retrofit: Yes Highway/Road: Yes</p>
	<p style="text-align: center;"><u>Stormwater Functions</u></p> <p>Volume Reduction: Low Recharge: Low Peak Rate Control: High Water Quality: Medium</p>
	<p style="text-align: center;"><u>Water Quality Functions</u></p> <p>TSS: 70% TP: 60% NO3: 30%</p>

Description

Wet Detention Ponds are stormwater basins that include a permanent pool for water quality treatment and additional capacity above the permanent pool for temporary storage. Wet Ponds should include one or more forebays that trap coarse sediment, prevent short-circuiting, and facilitate maintenance. The pond perimeter should generally be covered by a dense stand of emergent wetland vegetation. While they do not achieve significant groundwater recharge or volume reduction, they can be effective for pollutant removal and peak rate mitigation. Wet Ponds (WPs) can also provide aesthetic and wildlife benefits. WPs require an adequate source of inflow to maintain the permanent water surface. Due to the potential to discharge warm water, wet ponds should be used with caution near temperature sensitive waterbodies. Properly designed and maintained WPs generally do not support significant mosquito populations (O'Meara).

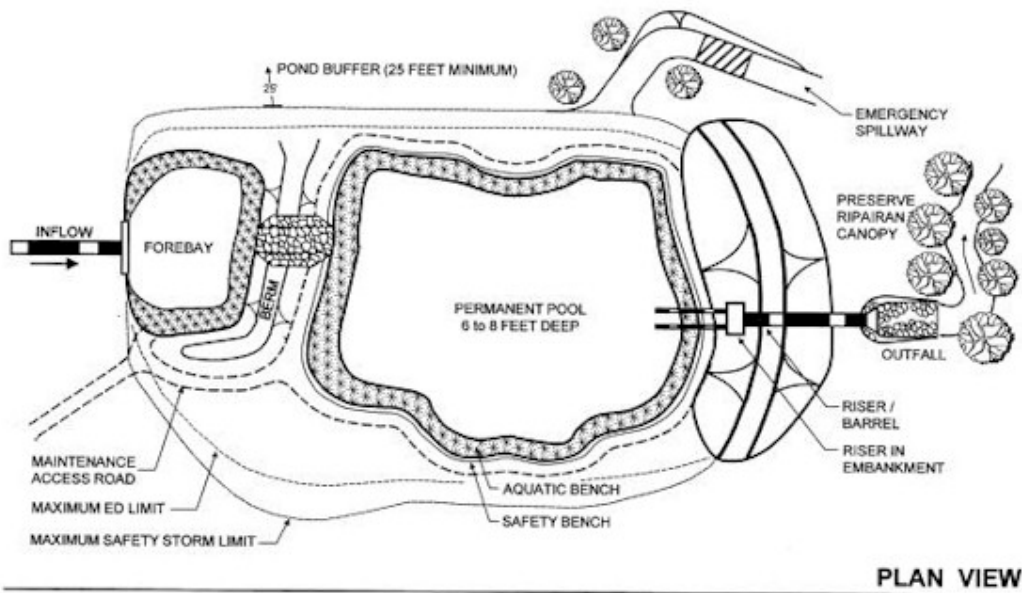

PLAN VIEW

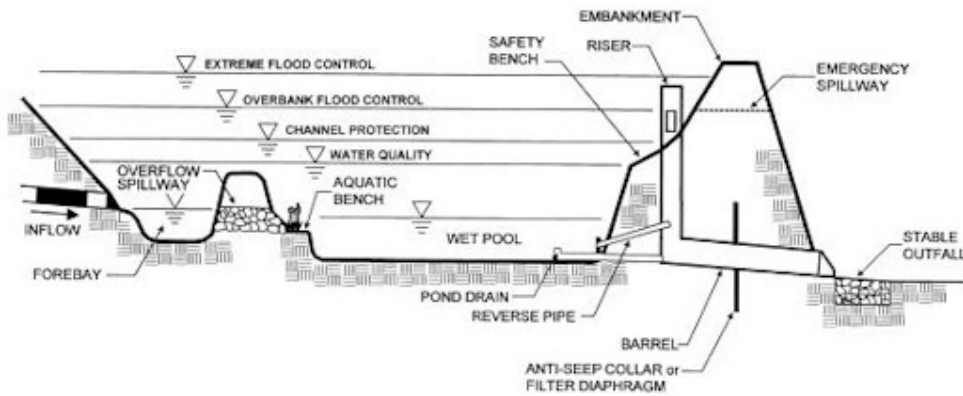

PROFILE

Variations

Wet Ponds can be designed as either an online or offline facilities. They can also be used effectively in series with other sediment reducing BMPs that reduce the sediment load such as vegetated filter strips, swales, and filters. Wet Ponds may be a good option for retrofitting existing dry detention basins. WPs are often organized into three groups:

- Wet Ponds primarily accomplish water quality improvement through displacement of the permanent pool and are generally only effective for small inflow volumes (often they are placed offline to regulate inflow).
- Wet Detention Ponds are similar to Wet Ponds but use extended detention as another mechanism for water quality and peak rate control.
- Pocket Wet Ponds are smaller WPs that serve drainage areas between approximately 5 and 10 acres and are constructed near the water table to help maintain the permanent pool. They often include extended detention as well.

This BMP focuses on Wet Detention Ponds as described above because this tends to be the most common and effective type of Wet Pond. For more information on other types of wet ponds, please consult the “References and Additional Resources” list.

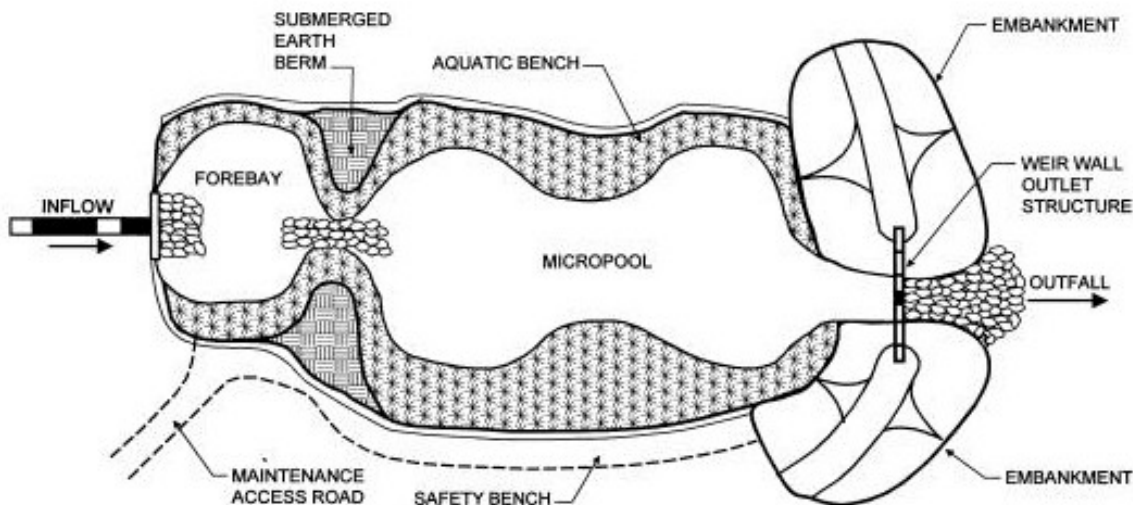

Applications

- **Wet Ponds**
- **Wet Detention Ponds**
- **Pocket Wet Pond**
- **Offline Wet Pond**
- **Retrofit for existing detention basins**



Design Considerations

1. **HYDROLOGY**. Wet Ponds should be able to receive and retain enough flow from rain, runoff, and groundwater to ensure long-term viability. A permanent water surface in the deeper areas of the WP should be maintained during all but the driest periods. A relatively stable permanent water surface elevation will reduce the stress on vegetation in and adjacent to the pond. A WP should have a drainage area of at least 10 acres (5 acres for Pocket Wet Ponds) or some means of sustaining constant inflow. Even with a large drainage area, a constant source of inflow can improve the biological health and effectiveness of a Wet Pond while discouraging mosquito growth. Pennsylvania's precipitation is generally well distributed throughout the year and is therefore suited for WPs.
2. **UNDERLYING SOILS**. Underlying soils must be identified and tested. Generally hydrologic soil groups "C" and "D" are suitable without modification, "A" and "B" soils may require modification to reduce permeability. Soil permeability must be tested in the proposed Wet Pond location to ensure that excessive infiltration will not cause the WP to dry out.
3. **PLANTING SOIL**. Organic soils should be used for shallow areas within Wet Ponds. Organic soils can serve as a sink for pollutants and generally have high water holding capacities. They will also facilitate plant growth and propagation and may hinder invasion of undesirable species.
4. **SIZE AND VOLUME**. The area required for a WP is generally 1 to 3 percent of its drainage area. WPs should be sized to treat the water quality volume and, if necessary, to mitigate the peak rates for larger events.
5. **VEGETATION**. Vegetation is an integral part of a Wet Pond system. Vegetation in and adjacent to a pond may enhance pollutant removal, reduce algal growth, limit erosion, improve aesthetics, create habitat, and reduce water warming (Mallin et al., 2002; NJ DEP, 2004; University of Wisconsin, 2000). Wet Ponds should have varying depths to encourage vegetation in shallow areas. The emergent vegetation zone (areas not more than 18" deep) generally supports the majority of aquatic vegetation and should include the pond perimeter. Robust, non-invasive, perennial plants that establish quickly are ideal for WPs. The designer should select species that are tolerant of a range of depths, inundation periods, etc. Monoculture planting should be avoided due to the risk from pests and disease. See local sources for recommended plant lists or Appendix B.

6. CONFIGURATION.

- a. General. Wet Ponds should be designed with a length to width ratio of at least 2:1 wherever possible. If the length to width ratio is lower, the flow pathway through the WP should be maximized. A wedge-shaped pond with the major inflows on the narrow end can prevent short-circuiting and stagnation. WPs should not be constructed within 10 feet of the property line or within 50 feet of a private well or septic system. Slopes in and around Wet Ponds should be 4:1 to 5:1 (horizontal:vertical) or flatter wherever possible (10:1 max. for safety/aquatic benches, see 6.d. below). Wet Ponds should have an average depth of 3 to 6 feet and a maximum depth of 8 feet. This should be shallow enough to minimize thermal stratification and short-circuiting and deep enough to prevent sediment resuspension, reduce algal blooms, and maintain aerobic conditions. Wet ponds should not be constructed within a natural watercourse.
 - b. Forebay/Inflows. Wet Ponds should have a forebay at all major inflow points to capture coarse sediment, prevent excessive sediment accumulation in the remainder of the WP, and minimize erosion by inflow. The forebays should contain 10 to 15 percent of the total permanent pool volume and should be 4 to 6 feet deep. They should be physically separated from the rest of the pond by a berm, gabion wall, etc. Flows exiting the forebay should be non-erosive to the newly constructed WP. Vegetation within forebays can increase sedimentation and reduce resuspension/erosion. The forebay bottom can be constructed of hardened materials to facilitate sediment removal. Forebays should be installed with permanent vertical markers that indicate sediment depth. Inflow channels should be fully stabilized. Inflow pipes can discharge to the surface or be partially submerged. Forebays should be offline (out of the path of higher flows) to prevent resuspension of previously collected sediment during large storms.
 - c. Outlet. Outlet control devices should draw from open water areas 5 to 7 feet deep to prevent clogging and allow the WP to be drained for maintenance and to provide for additional temperature benefits. Outlet devices are generally multistage structures with pipes, orifices, or weirs for flow control. A reverse slope pipe terminating 2 to 3 feet below the normal water surface, minimizes the discharge of warm surface water and is less susceptible to clogging by floating debris. Orifices, if used, should be at least 2.5 inches in diameter and should be protected from clogging. Outlet devices should be installed in the embankment for accessibility. If possible, outlet devices should enable the normal water surface to be varied. This allows the water level to be adjusted (if necessary) seasonally, as the WP accumulates sediment over time, if desired grades are not achieved, or for mosquito control. A pond drain should also be included which allows the permanent pool to be completely drained for maintenance within 24 hours. The outlet pipe should generally be fitted with an anti-seep collar through the embankment. Online facilities should have an emergency spillway that can safely pass the 100-year storm with 1 foot of freeboard. All outflows should be conveyed downstream in a safe and stable manner.
 - d. Safety/Aquatic Benches. All areas that are deeper than 4 feet should have two safety benches, totaling 15 feet in width. One should start at the normal water surface and extend up to the pond side slopes at a maximum slope of 10 percent. The other should extend from the water surface into the pond to a maximum depth of 18 inches, also at slopes no greater than 10 percent.
7. WET POND BUFFER. To enhance habitat value, visual aesthetics, water temperature, and pond health, a 25-foot buffer should be added from the maximum water surface elevation. The buffer should be planted with trees, shrubs, and native ground covers. Except in maintenance access areas, turf grass should not be used. Existing trees within the buffer should be preserved. If soils in the buffer will become compacted during construction, soil restoration should take place to aid buffer vegetation.

8. MAINTENANCE ACCESS. Permanent access must be provided to the forebay, outlet, and embankment areas. It should be at least 9 feet wide, have a maximum slope of 15%, and be stabilized for vehicles.
9. PLAN ELEMENTS. The plans detailing the Wet Ponds should clearly show the WP configuration, inlets and outlets, elevations and grades, safety/aquatic benches, and the location, quantity, and propagation methods of pond/buffer vegetation. Plans should also include site preparation techniques, construction sequence, as well as maintenance schedules and requirements.
10. REGULATION. Wet Ponds that have drainage areas over 100 acres, embankments greater than 15 feet high, or a capacity greater than 50 acre-feet may be regulated as a dam by PADEP (see Title 25, Chapter 105 of the Pennsylvania Code).



Detailed Stormwater Functions

Volume Reduction Calculations

Although not typically considered a volume-reducing BMP, Wet Ponds can achieve some volume reduction through infiltration and evapotranspiration, especially during small storms. According to the International Stormwater BMP Database, wet ponds have an average annual volume reduction of 7 percent (Strecker et al., 2004). Hydrologic calculations that should be performed to verify that the WP will have a viable amount of inflow can also predict the water surface elevation under varying conditions. The volume stored between the predicted water level and the lowest outlet elevation will be removed from the that design storm.

Peak Rate Mitigation Calculations

Peak rate is primarily controlled in Wet Ponds through the transient storage above the normal water surface. See Section 8 for Peak Rate Mitigation methodology.

Water Quality Improvement

Wet Ponds improve runoff quality through settling, filtration, uptake, chemical and biological decomposition, volatilization, and adsorption. WPs are relatively effective at removing many common stormwater pollutants including suspended solids, heavy metals, total phosphorus, total nitrogen, and pathogens. The pollutant removal effectiveness varies by season and may be affected by the age of the WP. It has been suggested that this type of BMP does not provide significant nutrient removal in the long term unless vegetation is harvested because captured nutrients are released back into the water by decaying plant material. Even if this is true, nutrients are usually released gradually and during the non-growing season when downstream susceptibility is generally low (Hammer, 1990). See Section 8 for Water Quality Improvement methodology, which addresses pollutant removal effectiveness of this BMP.

Construction Sequence

1. Separate wet pond area from contributing drainage area:
 - a. All channels/pipes conveying flows to the WP should be routed away from the WP area until it is completed and stabilized.
 - b. The area immediately adjacent to the WP should be stabilized in accordance with the PADEP's *Erosion and Sediment Pollution Control Program Manual* (2000 or latest edition) prior to construction of the WP.
2. Clearing and Grubbing:
 - a. Clear the area to be excavated of all vegetation.
 - b. Remove all tree roots, rocks, and boulders.
 - c. Fill all stump holes, crevices and similar areas with impermeable materials.
3. Excavate bottom of WP to desired elevation (Rough Grading).
4. Install surrounding embankments and inlet and outlet control structures.
5. Grade and prepare subsoil.

6. Apply and grade planting soil.
 - a. Matching design grades is crucial because aquatic plants can be very sensitive to depth.
7. Apply erosion-control measures.
8. Seed, plant and mulch according to Planting Plan
9. Install any anti-grazing measures, if necessary.
10. Follow required maintenance and monitoring guidelines.

Maintenance Issues

Wet Ponds should have a maintenance plan and privately owned facilities should have an easement, deed restriction, or other legal measure to prevent neglect or removal. During the first growing season or until established, vegetation should be inspected every 2 to 3 weeks. WPs should be inspected at least 4 times per year and after major storms (greater than 2 inches in 24 hours) or rapid ice breakup. Inspections should assess the vegetation, erosion, flow channelization, bank stability, inlet/outlet conditions, embankment, and sediment/debris accumulation. The pond drain should also be inspected and tested 4 times per year. Problems should be corrected as soon as possible. Wet Pond and buffer vegetation may need support (watering, weeding, mulching, replanting, etc.) during the first 3 years. Undesirable species should be carefully removed and desirable replacements planted if necessary.

Once established, properly designed and installed Wet Ponds should require little maintenance. Vegetation should maintain at least an 85 percent cover of the emergent vegetation zone and buffer area. Annual harvesting of vegetation may increase the nutrient removal of WPs; if performed it should generally be done in the summer so that there is adequate regrowth before winter. Care should be taken to minimize disturbance, especially of bottom sediments, during harvesting. The potential disturbance from harvesting may outweigh its benefits unless the WP receives a particularly high nutrient load or discharges to a nutrient sensitive waterbody. Sediment should be removed from the forebay before it occupies 50 percent of the forebay, typically every 5 to 10 years.

Cost Issues

The construction cost of Wet Ponds can vary greatly depending on the configuration, location, site-specific conditions, etc. Typical construction costs in 2004 dollars range from approximately \$25,000 to \$50,000 per acre-foot of storage (based on USEPA, 1999). Costs are generally most dependent on the amount of earthwork and the planting. Annual maintenance costs have been reported to be approximately 3 to 5 percent of the capital costs although there is little data available to support this. In addition to the construction and maintenance costs, there is the cost or loss of value for the property involved.

Specifications:

The following specifications are provided for information purposes only. These specifications include information on acceptable materials for typical applications, but are by no means exclusive or limiting. The designer is responsible for developing detailed specifications for individual design projects in accordance with the project conditions.

1. Excavation

- a. The area to be used for the WP should be excavated to the required depth below the desired bottom elevation to accommodate any required impermeable liner, organic matter, and/or planting soil.
- b. The compaction of the subgrade and/or the installation of any impermeable liners will follow immediately.

2. Subsoil Preparation

- a. Subsoil shall be free from hard clods, stiff clay, hardpan, ashes, slag, construction debris, petroleum hydrocarbons, or other undesirable material. Subsoil must not be delivered in a frozen or muddy state.
- b. Scarify the subsoil to a depth of 8 to 10 inches with a disk, rototiller, or similar equipment.
- c. Roll the subsoil under optimum moisture conditions to a dense layer with four to six passes of a sheepfoot roller or equivalent. The compacted layer shall be at least 8 inches thick.

3. Planting Soil (Topsoil)

- a. Use a minimum of 12 inches of topsoil in the emergent vegetation zone (less than 18" deep) of the pond. If natural topsoil from the site is to be used it must have at least 8 percent organic carbon content (by weight) in the A-horizon for sandy soils and 12% for other soil types.
- b. If planting soil is being imported it should be made up of equivalent proportions of organic and mineral materials.
- c. Lime should not be added to planting soil unless absolutely necessary as it may encourage the propagation of invasive species.
- d. The final elevations and hydrology of the vegetative zones should be evaluated prior to planting to determine if grading or planting changes are required.

4. Vegetation

- a. Plant Lists for WPs can be found locally. No substitutions of specified plants will be accepted without prior approval of the designer. Planting locations shall be based on the Planting Plan and directed in the field by a qualified wetland ecologist.
- b. All Wet Pond plant stock shall exhibit live buds or shoots. All plant stock shall be turgid, firm, and resilient. Internodes of rhizomes may be flexible and not necessarily rigid. Soft or mushy stock shall be rejected. The stock shall be free of deleterious insect infestation, disease and defects such as knots, sun-scald, injuries, abrasions, or disfigurement that could adversely affect the survival or performance of the plants.
- c. All stock shall be free from invasive or nuisance plants or seeds.
- d. During all phases of the work, including transport and onsite handling, the plant materials shall be carefully handled and packed to prevent injuries and desiccation. During transit and onsite handling, the plant material shall be kept from freezing and shall be kept covered, moist, cool, out of the weather, and out of the wind and sun. Plants shall be watered to maintain moist soil and/or plant conditions until accepted.
- e. Plants not meeting these specifications or damaged during handling, loading, and unloading will be rejected.
- f. Detailed planting specifications can be found locally, and in Appendix B.

5. Outlet Control Structure

- a. Outlet control structures shall be constructed of non-corrodible material.
- b. Outlets shall be resistant to clogging by debris, sediment, floatables, plant material, or ice.
- c. Materials shall comply with applicable specifications (PennDOT or AASHTO, latest edition)

References

- Auckland Regional Council. *Stormwater Management Devices: Design Guidelines Manual*. Auckland, New Zealand: 2003.
- Caraco, D. and Claytor, R. *Stormwater BMP Design Supplement for Cold Climates*. 1997.
- Center for Watershed Protection and Maryland Department of the Environment. *2000 Maryland Stormwater Design Manual*. Baltimore, MD: 2000.
- Center for Watershed Protection for NYS Department of Environmental Conservation. *New York State Stormwater Management Design Manual*. October 2001.
- CH2MHILL. *Pennsylvania Handbook of Best Management Practices for Developing Areas*. 1998.
- Cummings and Booth, circa 2003. "Stormwater Pollutant Removal by Two Wet Ponds in Bellevue, Washington." Department of Civil and Environmental Engineering, University of Washington, Seattle, WA, 23 pp.
- "Effectiveness of Best Management Practices (BMPs) for Stormwater Treatment." City of Greensboro (NC), Water Resources Department, circa 2000. Available as of October 2004 at <http://www.greensboro-nc.gov/stormwater/Quality/bmpeffectiveness.htm>.
- Federal Highway Administration, *Stormwater Best Management Practices in an Ultra-Urban Setting: Selection and Monitoring*. "Fact Sheet – Detention Basins."
- Hammer, D.A. (editor). *Constructed Wetlands for Wastewater Treatment, Municipal, Industrial and Agricultural*. Ann Arbor, MI: Lewis Publishers, 1990.
- Mallin, M.; Ensign, S.; Wheeler, T.; and Mayes, D. "Pollutant Removal Efficacy of Three Wet Detention Ponds." *Journal of Environmental Quality* 31: 654-660 (2002).
- New Jersey Department of Environmental Protection. *New Jersey Stormwater Best Management Practices Manual*. 2004.
- O'Meara, G.F. "Mosquito Associated with Stormwater Detention/Retention Areas." University of Florida, Institute of Food and Agricultural Sciences.
- Strecker, E.W.; Quigley, M.M.; Urbonas, B.; and Jones, J. "Analyses of the Expanded EPA/ASCE International BMP Database and Potential Implications for BMP Design." Proceedings of the World Water and Environmental Resources Congress 2004, Salt Lake City, Utah.
- United States Environmental Protection Agency (USEPA). *Storm Water Technology Fact Sheet: Wet Detention Ponds* (EPA 832-F-99-048) 1999.

BMP 6.6.3: Dry Extended Detention Basin



A dry extended detention basin is an earthen structure constructed either by impoundment of a natural depression or excavation of existing soil, that provides temporary storage of runoff and functions hydraulically to attenuate stormwater runoff peaks. The dry detention basin, as constructed in countless locations since the mid-1970's and representing the primary BMP measure until now, has served to control the peak rate of runoff, although some water quality benefit accrued by settlement of the larger particulate fraction of suspended solids. This extended version is intended to enhance this mechanism in order to maximize water quality benefits.

The basin outlet structure must be designed to detain runoff from the stormwater quality design storm for extended periods. Some volume reduction is also achieved in a dry basin through initial saturation of the soil mantle (even when compacted) and some evaporation takes place during detention. The net volume reduction for design storms is minimal, especially if the precedent soil moisture is assumed as in other volume reduction BMPs.

<p style="text-align: center;"><u>Key Design Elements</u></p> <ul style="list-style-type: none"> • Evaluation of the device chosen should be balanced with cost • Hydraulic capacity controls effectiveness • Ideal in combination with other BMPs • Regular maintenance is necessary including periodic sediment removal 	<p style="text-align: center;"><u>Potential Applications</u></p> <p style="text-align: center;">Residential: Yes Commercial: Yes Ultra Urban: Yes Industrial: Yes Retrofit: Yes Highway/Road: Yes</p>
	<p style="text-align: center;"><u>Stormwater Functions</u></p> <p style="text-align: center;">Volume Reduction: Low Recharge: None Peak Rate Control: High Water Quality: Low</p>
	<p style="text-align: center;"><u>Water Quality Functions</u></p> <p style="text-align: center;">TSS: 60% TP: 40% NO3: 20%</p>

Description

Dry extended detention basins are surface stormwater structures which provide for the temporary storage of stormwater runoff to prevent downstream flooding impacts. Water quality benefits may be achieved with extended detention of the runoff volume from the water quality design storm.

- The primary purpose of the detention basin is the attenuation of stormwater runoff peaks.
 - Detention basins should be designed to control runoff peak flow rates of discharge for the 1 year through 100 year events.
 - Inflow and discharge hydrographs should be calculated for each selected design storm. Hydrographs should be based on the 24-hour rainfall event.

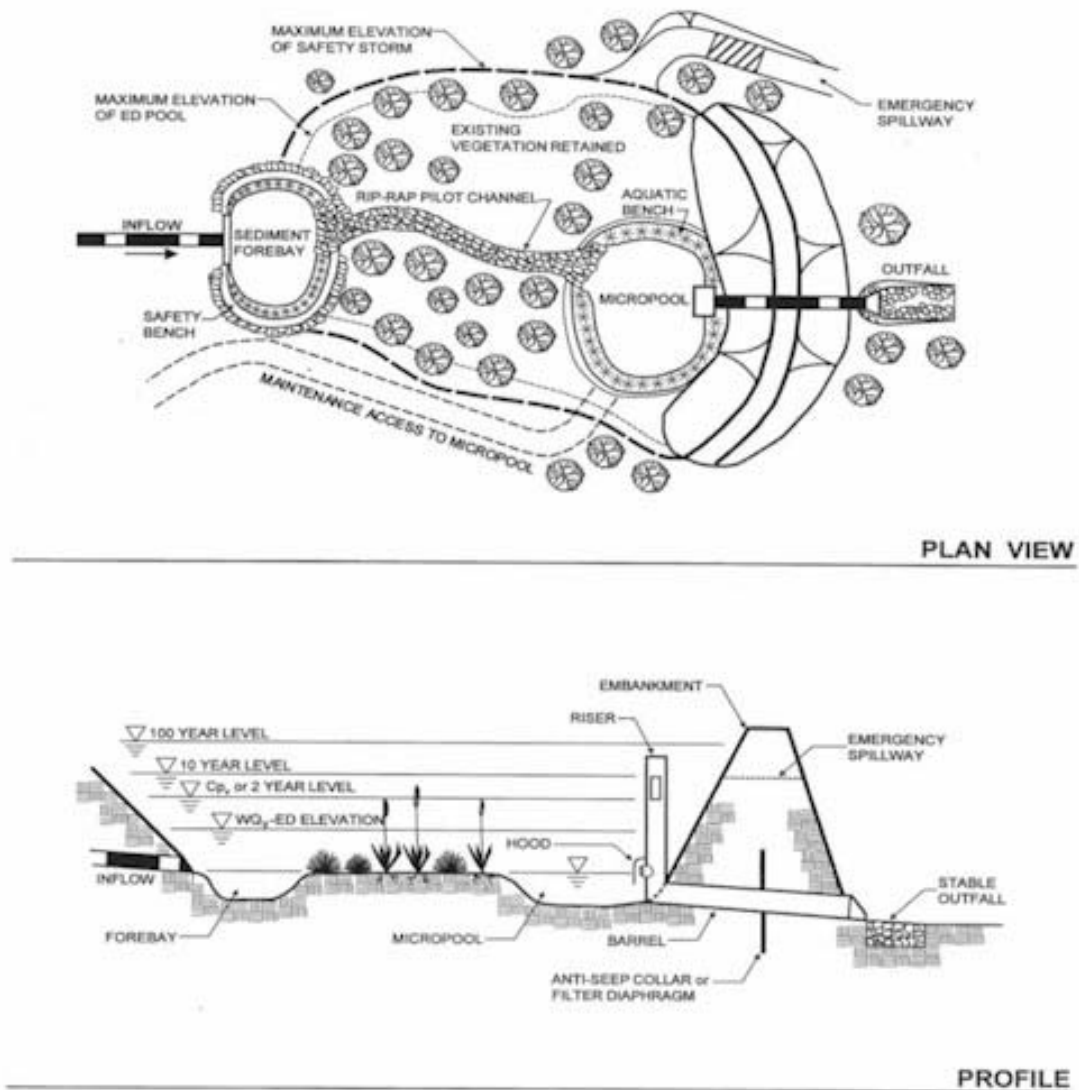

- Basins should be designed to provide water quality treatment storage to capture the computed runoff volume of the water quality design storm.
 - Detention basins should have a sediment forebay or equivalent upstream pretreatment. The forebay should consist of a separate cell that is offline (so as to not resuspend sediment, formed by an acceptable barrier and will need periodic sediment removal.

- A micropool storage area should be designed where feasible for the extended detention of runoff volume from the water quality design storm.
- Flow paths from inflow points to outlets should be maximized.

Variations

Sub-surface extended detention

Extended detention storage can also be provided in a variety of sub-surface structural elements, such as underground vaults, tanks, large pipes or other structural media placed in an aggregate filled bed in the soil mantle. All such systems are designed to provide runoff peak rate mitigation as their primary function, but some pollutant removal may be included. Regular maintenance is needed, since the structure must be drained within a design period and cleaned to assure detention capacity for subsequent rainfall events. These facilities are usually intended for space-limited applications and are not intended to provide significant water quality treatment.

- Underground vaults are typically box shaped underground stormwater storage facilities constructed of reinforced concrete, while tanks are usually constructed of large diameter metal or plastic pipe. They may be situated within a building, but the use of internal space is frequently not cost beneficial.
 - Storage design and routing methods are the same as for surface detention basins.
 - Underground vaults and tanks do not provide water quality treatment and should be used in combination with a pretreatment BMP.
- Underground detention beds can be constructed by excavating a subsurface area and filling with uniformly graded aggregate for support of overlying land uses.
 - This approach may be used where space is limited but subsurface infiltration is not feasible due to high water table conditions or shallow soil mantle.
 - As with detention vaults and tanks, this facility provides minimal water quality treatment and should be used in combination with a pretreatment BMP.
 - It is recommended that underground detention facilities not be lined to allow for even minimal infiltration, except in the case where toxic contamination is possible.

Applications

- **Low Density Residential Development**
- **Industrial Development**
- **Commercial Development**
- **Urban Areas**

Design Considerations

1. Storage Volume, Depth and Duration

- a. Extended detention basins should be designed to mitigate runoff peak flow rates.
- b. An emergency outlet or spillway which is capable of conveying the spillway design flood (SDF) should be included in the design. The SDF is usually equal to the 100-year design flood
- c. Extended detention basins should be designed to treat the runoff volume produced by the water quality design storm.

- d. Extended Detention Basins are designed to achieve a specified detention time. Details on the detention time are outlined in Chapter 3.
- e. The lowest elevation within an extended dry detention basin should be at least 2 feet above the seasonal high water table. If high water table conditions are anticipated, then the design of a wet pond, constructed wetland or bioretention facility should be considered.

2. Dry Extended Detention Basin Location

- a. Extended detention basins should be located down gradient of disturbed or developed areas on the site. The basin should collect as much site runoff as possible, especially from the site's impervious surfaces (roads, parking, buildings, etc.).
- b. Extended detention basins should not be constructed on steep slopes, nor should slopes be significantly altered or modified to reduce the steepness of the existing slope, for the purpose of installing a basin.
- c. Extended detention basins should not worsen the runoff potential of the existing site by removal of trees for the purpose of installing a basin.
- d. Extended detention basins should not be constructed in areas with high quality and/or well draining soils, which are adequate for the installation of BMPs capable of achieving stormwater infiltration.
- e. Extended detention basins should not be constructed within jurisdictional waters, including wetlands.

3. Basin Sizing and Configuration

- a. Basins should be shaped to maximize the length of stormwater flow pathways and minimize short-circuited inlet-outlet systems. Basins should have a minimum width of 10 feet. A minimum length-to-width ratio of 2:1 is recommended to maximize sedimentation.
- b. Irregularly shaped basins are encouraged and appear more natural.
- c. If site conditions inhibit construction of a long, narrow basin, baffles constructed from earthen berms or other materials can be incorporated into the pond design to "lengthen" the stormwater flow path. Care should be taken to ensure the design storage capacity is provided after baffle installation.
- d. Low flow channels, if required, should always be vegetated with a maximum slope of 3 percent to encourage sedimentation. Alternatively, other BMPs may be considered such as wet ponds, constructed wetlands or bioretention.

4. Embankments

- a. Embankments should be less than 15 feet in height and should have side slopes no steeper than 3:1 (H:V).
- b. The basin should have a minimum freeboard of 1 foot above the SDF elevation.

5. Inlet Structures

- a. Inlet structures to basin should not be submerged at the normal pool depth.
- b. Erosion protection measures should be utilized to stabilize inflow structures and channels.

6. Outlet Design

- a. In order to meet design storm requirements, dry extended detention basins should have a multistage outlet structure. Three elements are typically included in this design:
 1. A low-flow outlet that controls the extended detention and functions to slowly release the water quality design storm.
 2. A primary outlet that functions to attenuate the peak of larger design storms.
 3. An emergency overflow outlet/spillway
- b. The primary outlet structure should incorporate weirs, orifices, pipes or a combination of these to control runoff peak rates for required design storms. Water quality storage should be provided below the invert of the primary outlet. When routing basins, the low-flow outlet should be included in the depth-discharge relationship.
- c. Energy dissipaters are to be placed at the end of the primary outlet to prevent erosion. If the basin discharges to a channel with dry weather flow, care should be taken to minimize tree clearing along the downstream channel and to reestablish a forested riparian zone between the outlet and natural channel. Where feasible, a multiple orifice outlet system is preferred to a single pipe.
- d. The orifice should typically be no smaller than 2.5 inches in diameter. However, the orifice diameter may be reduced to 1 inch if adequate protection from clogging is provided.
- e. The hydraulic design of all outlet structures should consider any tailwater effects of downstream waterways.
- f. The primary and low flow outlet should be protected from clogging by an external trash rack.

7. Sediment Forebay

- a. Forebays should be incorporated into the extended detention design. The forebay storage volume is included for the water quality volume requirement.
- b. Forebays should be vegetated to improve filtering of runoff, to reduce runoff velocity, and to stabilize soils against erosion. Forebays are typically constructed as shallow marsh areas and should adhere to the following design criteria:
 1. It is recommended that forebays have a minimum length of 10 feet.
 2. Storage should be provided to trap the anticipated sediment volume produced over a period of 2 years.
 3. Forebays should be protected from the erosive force of the inflow to prevent resuspension of previously collected sediment during large storms (typically constructed offline).



8. Vegetation and Soils Protection

- a. Care should be taken to prevent compaction of in situ soils in the bottom of the extended detention basin in order to promote healthy plant growth and to encourage infiltration. If soils compaction is not prevented during construction, soils should be restored as discussed in BMP 6.7.3 – Soils Amendment & Restoration.
- b. It is recommended that basin bottoms be vegetated in a diverse native planting mix to reduce maintenance needs, promote natural landscapes, and increase infiltration potential. Vegetation may include trees, woody shrubs and meadow/wetland herbaceous plants.
- c. Woody vegetation should not be planted on the embankments or within 25 feet of the emergency overflow spillway.
- d. Meadow grasses or other deeply rooted herbaceous vegetation is recommended on the interior slope of embankments.
- e. Fertilizers and pesticides should not be used.

9. Special Design Considerations

- a. Ponds that have embankments higher than 15 feet, have a drainage of more than 100 acres or will impound more that 50 acre-feet of runoff during the high-water condition will be regulated as dams by PADEP. The designer shall consult Pennsylvania Chapter 105 to determine which provisions may apply to the specific project in question.
- b. Extended detention ponds should not be utilized as recreation areas due to health and safety issues. Design features that discourage access are recommended.

Detailed Stormwater Functions

Peak Rate Mitigation

Inflow and discharge hydrographs should be calculated and routed for each design storm. Hydrographs should be based on a 24-hour rainfall event.

Water Quality Improvement

Water quality mitigation is partially achieved by retaining the runoff volume from the water quality design storm for a minimum prescribed period as specified in Chapter 3. Sediment forebays should be incorporated into the design to improve sediment removal. The storage volume of the forebay may be included in the calculated storage of the water quality design volume.

Construction Sequence

1. Install all temporary erosion and sedimentation controls.
 - a. The area immediately adjacent to the basin must be stabilized in accordance with the PADEP's *Erosion and Sediment Pollution Control Program Manual* (2000 or latest edition) prior to basin construction.
2. Prepare site for excavation and/or embankment construction.
 - a. All existing vegetation should remain if feasible and should only be removed if necessary for construction.
 - b. Care should be taken to prevent compaction of the basin bottom.
 - c. If excavation is required, clear the area to be excavated of all vegetation. Remove all tree roots, rocks, and boulders only in excavation area
3. Excavate bottom of basin to desired elevation (if necessary).
4. Install surrounding embankments and inlet and outlet control structures.
5. Grade subsoil in bottom of basin, taking care to prevent compaction. Compact surrounding embankment areas and around inlet and outlet structures.
6. Apply and grade planting soil.
7. Apply geo-textiles and other erosion-control measures.
8. Seed, plant and mulch according to Planting Plan
9. Install any anti-grazing measures, if necessary.

Maintenance Issues

Maintenance is necessary to ensure proper functionality of the extended detention basin and should take place on a quarterly basis. A basin maintenance plan should be developed which includes the following measures:

- All basin structures expected to receive and/or trap debris and sediment should be inspected for clogging and excessive debris and sediment accumulation at least four times per year, as well as after every storm greater than 1 inch.
 - Structures include basin bottoms, trash racks, outlets structures, riprap or gabion structures, and inlets.
- Sediment removal should be conducted when the basin is completely dry. Sediment should be disposed of properly and once sediment is removed, disturbed areas need to be immediately stabilized and revegetated.
- Mowing and/or trimming of vegetation should be performed as necessary to sustain the system, but all detritus should be removed from the basin.
 - Vegetated areas should be inspected annually for erosion.
 - Vegetated areas should be inspected annually for unwanted growth of exotic/invasive species.
 - Vegetative cover should be maintained at a minimum of 95 percent. If vegetative cover has been reduced by 10%, vegetation should be reestablished.

Cost Issues

The construction costs associated with dry extended detention basins can range considerably. One recent study evaluated the cost of all pond systems (Brown and Schueler, 1997). Before adjusting for inflation from 1997, the cost of dry extended detention ponds can be estimated with the equation:

$$C = 12.4V^{0.760}$$

Where:

C = Construction, Design and Permitting Cost

V = Volume needed to control the 10-year storm (cubic feet)

Using this equation, a typical construction costs (1997) are:

\$ 41,600 for a 1 acre-foot pond

\$ 239,000 for a 10 acre-foot pond

\$ 1,380,000 for a 100 acre-foot pond

Dry extended detention basins utilizing highly structural design features (rip-rap for erosion control, etc.) are more costly than naturalized basins. There is an installation cost savings associated with a natural vegetated slope treatment which is magnified by the additional environmental benefits provided. Long-term maintenance costs are reduced when more naturalized approaches are utilized due to the ability of native vegetation to adapt to local weather conditions and a reduced need for maintenance, such as mowing and fertilization.

Normal maintenance costs can be expected to range from 3 to 5 percent of the construction costs on an annual basis.

These costs don't include the cost or value of the property.

Specifications

The following specifications are provided for information purposes only. These specifications include information on acceptable materials for typical applications, but are by no means exclusive or limiting. The designer is responsible for developing detailed specifications for individual design projects in accordance with the project conditions.

1. Site Preparation

- a. All excavation areas, embankments, and where structures are to be installed shall be cleared and grubbed as necessary, but trees and existing vegetation should be retained and incorporated within the dry detention basin area where possible.
- b. Where feasible, trees and other native vegetation should be protected. A minimum 10-foot radius around the inlet and outlet structures can be cleared to allow construction.
- c. Any cleared material should be used as mulch for erosion control or soil stabilization.
- d. Care should be taken to prevent compaction of the bottom of the reservoir. If compaction should occur, soils should be restored and amended.

2. Earth Fill Material & Placement

- a. The fill material should be taken from approved designated excavation areas. It should be free of roots, stumps, wood, rubbish, stones greater than 6 inches, or other

objectionable materials. Materials on the outer surface of the embankment must have the capability to support vegetation.

- b. Areas where fill is to be placed should be scarified prior to placement. Fill materials for the embankment should be placed in maximum 8-inch lifts. The principal spillway should be installed concurrently with fill placement and not excavated into the embankment.
 - c. The movement of the hauling and spreading equipment over the site should be controlled. For the embankment, each lift should be compacted to 95% of the standard proctor. Fill material should contain sufficient moisture so that if formed in to a ball it will not crumble, yet not be so wet that water can be squeezed out.
- 3. Embankment Core**
- a. The core should be parallel to the centerline of the embankment as shown on the plans. The top width of the core should be at least four feet. The height should extend up to at least the 10-year water elevation or as shown on the plans. The side slopes should be 1 to 1 or flatter. The core should be compacted with construction equipment, rollers, or hand tampers to assure maximum density and minimum permeability. The core should be placed concurrently with the outer shell of the embankment.
- 4. Structure Backfill**
- a. Backfill adjacent to pipes and structures should be of the type and quality conforming to that specified for the adjoining fill material. The fill should be placed in horizontal layers not to exceed four inches in thickness and compacted by hand tampers or other manually directed compaction equipment. The material should fill completely all spaces under and adjacent to the pipe. At no time during the backfilling operation should driven equipment be allowed to operate closer than four feet to any part of the structure. Equipment should not be driven over any part of a concrete structure or pipe, unless there is a compacted fill of 24 inches or greater over the structure or pipe.
 - b. Structure backfill may be flowable fill meeting the requirements of the PADOT Standard Specifications for Construction. Material should be placed so that a minimum of 6 inches of flowable fill should be under (bedding), over and, on the sides of the pipe. It only needs to extend up to the spring line for rigid conduits. Average slump of the fill material should be 7 inches to assure flowability of the mixture. Adequate measures should be taken (sand bags, etc.) to prevent floating the pipe. When using flowable fill all metal pipe should be bituminous coated. Adjoining soil fill should be placed in horizontal layers not to exceed 4 inches in thickness and compacted by hand tampers or other manually directed compaction equipment.
 - c. Refer to Chapter 220 Of PennDot Pub. 408 (2000).
- 5. Rock Riprap**
- a. Rock riprap should meet the requirements of Pennsylvania Department of Transportation Standard Specifications.
- 6. Stabilization**
- a. All borrow areas should be graded to provide proper drainage and left in a slightly condition. All exposed surfaces of the embankment, spillway, spoil and borrow areas, and berms should be stabilized by seeding, planting and mulching.
- 7. Operation and Maintenance**
- a. An operation and maintenance plan in accordance with Local or State Regulations will be prepared for all basins. As a minimum, a dam and inspection checklist should be included as part of the operation and maintenance plan and performed at least annually.

References

- AMEC Earth and Environmental Center for Watershed Protection et al. *Georgia Stormwater Management Manual*. 2001.
- Brown, W. and T. Schueler. 1997. *The Economics of Stormwater BMPs in the Mid-Atlantic Region*. Prepared for: Chesapeake Research Consortium. Edgewater, MD. Center for Watershed Protection. Ellicott City, MD.
- California Stormwater Quality Association. *California Stormwater Best Management Practices Handbook: New Development and Redevelopment*. 2003.
- CH2MHILL. *Pennsylvania Handbook of Best Management Practices for Developing Areas*. 1998.
- Chester County Conservation District. *Chester County Stormwater BMP Tour Guide-Permanent Sediment Forebay*, 2002.
- Commonwealth of PA, Department of Transportation. *Pub 408 - Specifications*. 1990. Harrisburg, PA. Maryland Department of the Environment. *Maryland Stormwater Design Manual*. 2000.
- Milner, George R. 2001. *Conventional vs. Naturalized Detention Basins: A Cost/Benefit Analysis*. Prepared for: The Illinois Association for Floodplain and Stormwater Management. Park Forest, IL
- New Jersey Department of Environmental Protection. *New Jersey Stormwater Best Management Practices Manual*. 2004.
- Stormwater Management Fact Sheet: Dry Extended Detention Pond – www.stormwatercenter.net
- Vermont Agency of Natural Resources. *The Vermont Stormwater Management Manual*. 2002.
- Washington State Department of Ecology. *Stormwater Management Manual for Eastern Washington (Draft)*. Olympia, WA: 2002.

BMP 6.6.4: Water Quality Filters & Hydrodynamic Devices

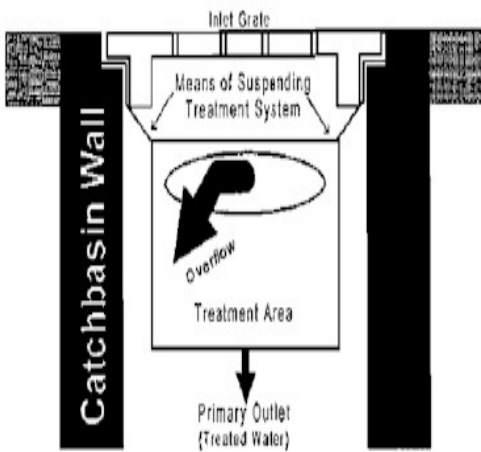

A broad spectrum of BMPs have been designed to remove non point source pollutants from runoff as a part of the runoff conveyance system. These structural BMPs vary in size and function, but all utilize some form of settling and filtration to remove particulate pollutants from stormwater runoff, a difficult task given the concentrations and flow rates experienced. Regular maintenance is critical for this BMP. Many water quality filters, catch basin inserts and hydrodynamic devices are commercially available. They are generally configured to remove particulate contaminants, including coarse sediment, oil and grease, litter, and debris.

<ul style="list-style-type: none"> ▪ Choose a device that (collectively) has the hydraulic capacity to treat the design storm ▪ Evaluation of the device chosen should be balanced with cost ▪ Hydraulic capacity controls effectiveness ▪ Most useful in small drainage areas (< 1 Acre) ▪ Ideal in combination with other BMPs ▪ Regular maintenance is necessary 	<p style="text-align: center;">s</p> <p style="text-align: center;"><u>Stormwater Functions</u></p> <p style="text-align: center;">Volume Reduction: None Recharge: None Peak Rate Control: None Water Quality: Medium</p> <p style="text-align: center;"><u>Water Quality Functions</u></p> <p style="text-align: center;">TSS: 60% TP: 50% NO3: 20%</p>
--	---

Other Considerations

- See Manufacturers specifications for estimated pollutant removal efficiencies.

Description

Water Quality Inlets are stormwater inlets that have been fitted with a proprietary product (or the proprietary product replaces the catch basin itself). They are designed to reduce large sediment, suspended solids, oil and grease, and other pollutants, especially pollutants conveyed with sediment transport. They can provide “hotspot” control and reduce sediments loads to infiltration devices. They are commonly used as pretreatment for other BMPs. The manufacturer usually provides the mechanical design, construction, and installation instructions. Selection of the most appropriate device and development of a maintenance plan should be carefully considered by the Designer.

The size of a water quality inlet limits the detention time and the hydraulic capacity influences the effectiveness of the water quality insert. Most products are designed for an overflow in large storm events, which is necessary hydraulically and still allows for a “first flush” treatment.

Regular maintenance according to application and manufacturer’s recommendations is essential for continued performance.

Variations

Tray types

Allows flow to pass through filter media that is contained in a tray located around the perimeter of the inlet. Runoff enters the tray and leaves via weir flow under design conditions. High flows pass over the tray and into the inlet unimpeded.

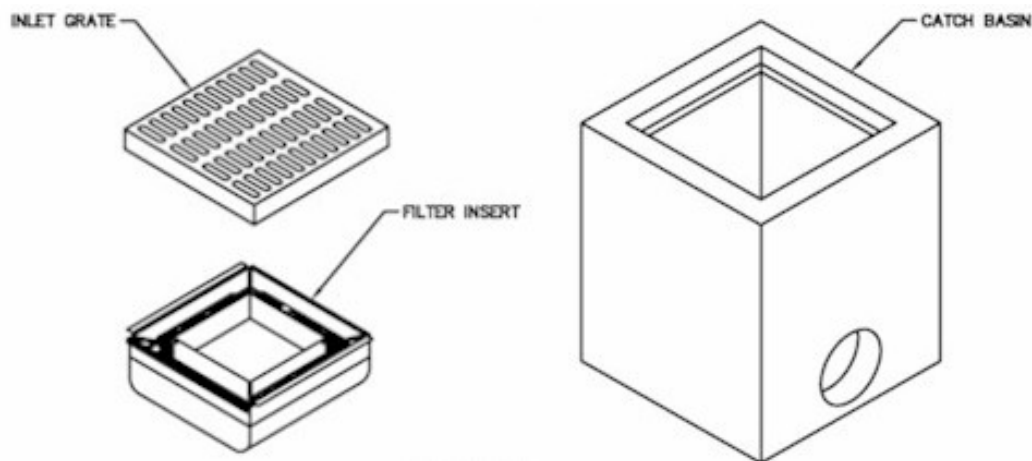

Bag types

Insert is made of fabric and is placed in the drain inlet around the perimeter of the grate. Runoff passes through the bag before discharging into the drain outlet pipe. Overflow holes are usually provided to pass larger flows without causing a backwater at the grate. Certain manufactured products include polymers intended to increase pollutant removal effectiveness.

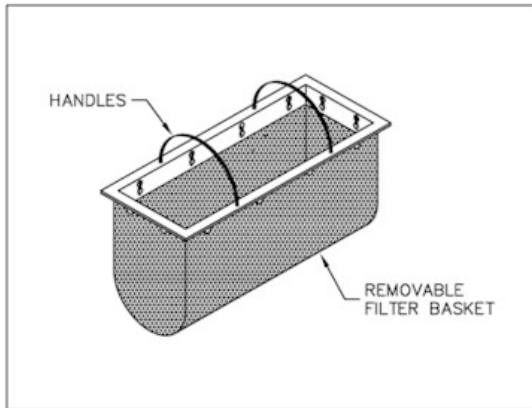

Basket types

The insert consists of “basket type” insert that sets into the inlet and has a handle to remove basket for maintenance. Small orifices allow small storm events to weep through, while larger storms overflow the basket. Primarily useful for debris and larger sediment, and requires consistent and frequent maintenance.



Simple, “sumps” in inlets

Space created in inlets below the invert of the pipes for sediment and debris to deposit, usually leaving 6-inches to 12-inches at the bottom of an inlet. Small weep holes should be drilled into the bottom of the inlet to prevent standing water for long periods of time. Regular maintenance is required.

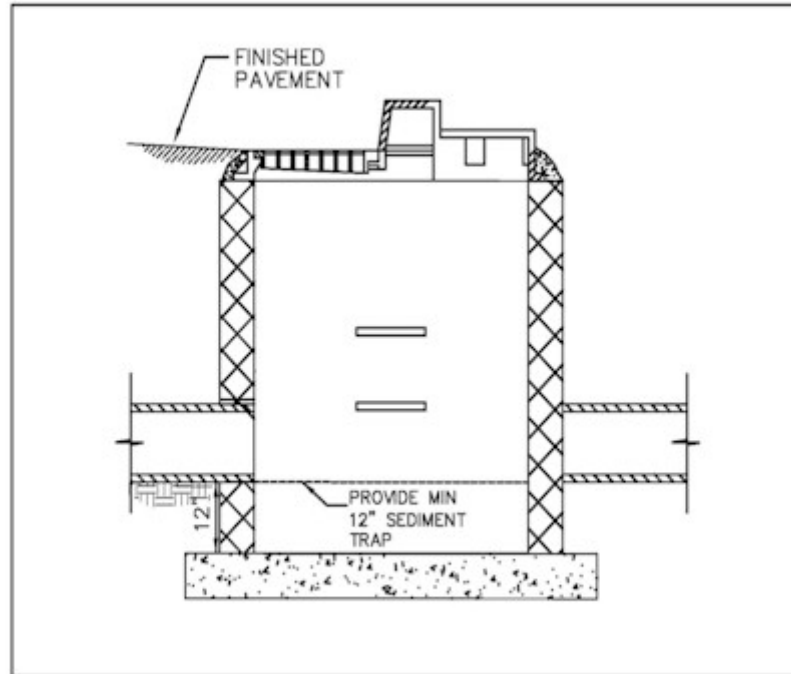

Description - Hydrodynamic Devices

Hydrodynamic Devices are not truly inserts, but separate flow through devices designed to serve in concert with inlets and storm sewer. A variety of products are available from different manufacturers. The primary purpose is to use various methods to remove sediments and pollutants. These methods include baffle plate design, vortex design, tube settler design, inclined plate settler design or a combination of these. Ideally, the flow through device should remove litter, oil, sediment, heavy metals, dissolved solids and nutrients. Removal ability varies as a result of loading rate and design. Clays and fine silts do not easily settle out unless they are coagulated with some kind of chemical addition or polymer. These devices work most effectively in combination with other BMPs, either as a pre-treatment or as a final treatment at the end of a pipe.

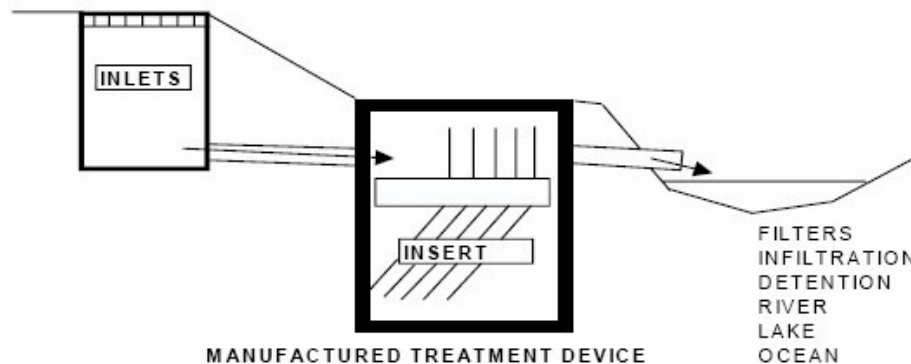

Applications

Any existing or proposed inlet where the contributing runoff may contain significant levels of sediment and debris, for example: parking lots, gas stations, golf courses, streets, driveways, industrial or commercial facilities, and municipal corporation yards. Commonly used as pretreatment before other stormwater BMPs.

Design Considerations

1. Match site considerations with manufacturer's guidelines/specifications (i.e. land use will determine specific pollutants to be removed from runoff).
2. Prevent re-suspension of particles by using small drainage areas and good maintenance.
3. Retrofits should be designed to fit existing inlets.
4. Placement should be accessible to maintenance.
5. If used as part of Erosion & Sedimentation Control during construction, insert should be reconfigured (if necessary) per manufacture's guidelines.
6. Overflow should be designed so that storms in excess of the device's hydraulic capacity bypass the treatment and is treated by another quality BMP.

Detailed Stormwater Functions

Volume Reduction Calculations

N/A

Peak Rate Mitigation Calculations

N/A

Water Quality Improvement

See manufacturers specifications and tests.

Construction Sequence

1. Stabilize all contributing areas before installing and connecting pipes to these inlets.
2. Follow manufacturer's guidelines for installation. Do not use water quality inserts during construction unless product is designed primarily for sediment removal. (Some products have adsorption components that should be installed post-construction.)

Maintenance Issues

Follow the manufacturer's guidelines for maintenance, also taking into account expected pollutant load and site conditions. Inlets should be inspected weekly during construction. Post-construction, they should be emptied when over half full of sediment (and trash) and cleaned at least twice a year. They

should also be inspected after runoff events. Maintenance is crucial to the effectiveness of this BMP. The more frequent a water quality insert is cleaned, the more effective it will be. One study (Pitt, 1985) found that WQI's can store sediment up to 60% of its sump volume, and after that, the inflow resuspends the sediments into the stormwater. Some sites have found keeping a log of sediment amount date removed helpful in planning a maintenance schedule. Environmental Technology Verification (ETV) Program and the Technology Acceptance and Reciprocity Partnership (TARP) may be available to assist with the development of a monitoring plan. These programs are detailed in Section 6.3.



Disposal of removed material will depend on the nature of the drainage area and the intent and function of the water quality insert. Material removed from water quality inserts that serve "Hot Spots" such as fueling stations or that receive a large amount of debris should be handled according to DEP regulations for that type of solid waste, such as a landfill that is approved by DEP to accept solid waste. Water quality inserts that primarily catch sediment and detritus from areas such as lawns may reuse the waste on site.

Vactor trucks may be an efficient cleaning mechanism.

Winter Concerns: There is limited data studying cold weather effects on water quality insert effectiveness. Freezing may result in more runoff bypassing the treatment system. Salt stratification may also reduce detention time. Colder temperatures reduce the settling velocity of particles, which can result in fewer particles being "trapped". Salt and sand are significantly increased in the winter, and may warrant more frequent maintenance. Sometimes freezing makes accessing devices for maintenance difficult.

Cost Issues

Check with manufacturers for current prices.

Specifications

Follow manufacturer's instructions and specific specifications.

References

Brzozowski, C., 2003. "Inlet Protection – Strategies for Preserving Water Quality," Stormwater magazine.

Lee, F. "The Right BMPs? Another Look at Water Quality." Stormwater magazine.

New Hampshire Watershed Management Bureau, Watershed Assistance Section, 2002. "Innovative Stormwater Treatment Technologies BMP Manual."

Pitt, R. *Characterizing and Controlling Urban Runoff through Street and Sewerage Cleaning*. US EPA, June 1985.

6.7 Restoration BMPs

BMP 6.7.1: Riparian Buffer Restoration



A riparian buffer is a permanent area of trees and shrubs located adjacent to streams, lakes, ponds, and wetlands. Riparian forests are the most beneficial type of buffer for they provide ecological and water quality benefits. Restoration of this ecologically sensitive habitat is a responsive action to past activities that may have eliminated any vegetation.

<p style="text-align: center;"><u>Key Design Elements</u></p> <ul style="list-style-type: none"> ▪ Reestablish buffer areas along perennial, intermittent, and ephemeral streams ▪ Plant native, diverse tree and shrub vegetation ▪ Buffer width is dependant on project preferred function (water quality, habitat creation, etc.) ▪ Minimum recommended buffer width is 35' from top of stream bank, with 100' preferred. ▪ Create a short-term maintenance and long-term maintenance plan ▪ Mature forest as a vegetative target ▪ Clear, well-marked boundary 	<p style="text-align: center;"><u>Potential Applications</u></p> <p>Residential: Yes Commercial: Yes Ultra Urban: Yes Industrial: Yes Retrofit: Yes Highway/Road: Limited</p>
	<p style="text-align: center;"><u>Stormwater Functions</u></p> <p>Volume Reduction: Medium Recharge: Medium Peak Rate Control: Low/Med. Water Quality: Med./High</p>
	<p style="text-align: center;"><u>Water Quality Functions</u></p> <p>TSS: 65% TP: 50% NO3: 50%</p>

Description

The USDA Forest Service estimates that over one-third of the rivers and streams in Pennsylvania have had their riparian areas degraded or altered. This fact is sobering when one considers the important stormwater functions that riparian buffers provide. The non-structural BMP, Riparian Forest Buffer Protection, addresses the importance of protecting the three-zone system of existing riparian buffers.

The values of riparian buffers – economic, environmental, recreational, aesthetic, etc. – are well documented in scientific literature and numerous reports and thus will not be restated here in this BMP sheet. Rather, this BMP serves to provide a starting point for the designer that seeks to restore the riparian buffer. Important reports are cited consistently throughout this section and should be mentioned upfront as sources for additional information to a designer seeking to restore a riparian buffer. The first, the *Chesapeake Bay Riparian Handbook: a Guide for Establishing and Maintaining Riparian Forest Buffers* was prepared by the US Department of Agriculture (USDA) Forest Service for the Chesapeake Bay Program in 1997. The second, the *Pennsylvania Stream ReLeaf Forest Buffer Toolkit* was developed by the Alliance for the Chesapeake Bay specifically for the Pennsylvania streams in 1998. A third and often-referenced report, is the *Riparian Forest Buffers* series written by Robert Tjaden for the Maryland Cooperative Extension Service in 1998.

Riparian buffers are scientifically proven to provide a number of economic and environmental values. Buffers are characterized by high species density, high species diversity, and high bio-productivity as a transition between aquatic and upland environments. Project designers should take into account the benefits or services provided by the buffer and apply these to their project goals. Priorities for riparian buffer use should be established early on in the planning stages. Some important considerations when establishing priorities are:

- **Habitat** – Restoring a buffer for habitat enhancement will require a different restoration strategy than for restoring a buffer for increased water quality.
- **Stream Size** – A majority of Pennsylvania’s stream miles is comprised of small streams (first, second, and third order), which may be priority areas to reduce nutrients. Establishing riparian buffers along these headwater streams will reduce the high nutrient loads relative to flow volumes typical of small streams.
- **Continuous Buffers** - Establishing continuous riparian forest buffers in the landscape should be given a higher priority than establishing larger but fragmented buffers. Continuous buffers provide better stream shading and water quality protection, as well as corridors for the movement of wildlife.
- **Degree of Degradation** – Urban streams are usually buried or piped. Streams in areas without forests, such as pastures, may benefit the most from buffer restoration, as sources of headwater streams. Highly urbanized/altered streams may not be able to provide high levels of pollution control.
- **Loading Rates** - The removal of pollutants may be highest where nutrient and sediment loading are the highest.
- **Land Use** – Adjacent land uses will influence Buffer Width and Vegetation types used to establish a riparian buffer. While the three-zone riparian-forested buffers described earlier are the ideal, they may not always be feasible to establish, especially in urban situations.

Preparation of a *Riparian Buffer Restoration Plan* is critical to ensuring long-term success of the project and should be completed before any planting is to occur. It is essential that site conditions are well understood, objectives of the landowner are considered, and the appropriate plants chosen for the site, tasks that are completed in the planning stages. Below is a summary of the nine steps that are recommended for the planning stages of a buffer restoration project.

1. Obtain Landowner Permission and Support

Landowner commitment is essential for the success of the project. Landowners must be aware of all maintenance activities that will occur once buffer is planted.

2. Make Sure Site is Suitable for Restoration

If streambanks are extensively eroded, consider an alternative location. Rapidly eroding streambanks may undermine seedlings. Streambank restoration may need to occur prior to riparian buffer restoration. Obtain professional help in evaluating the need for streambank restoration.

3. Analyze Site’s Physical Conditions

The most important physical influence of the site is the soil, which will control plant selection. Evaluate the soil using the County soil survey book to determine important soil characteristics such as flooding potential, seasonal high water table, topography, soil pH, soil moisture, etc. Also, a simple field test can suffice, with direct observation of soil conditions.

4. Analyze Site’s Vegetative Features

Existing vegetation present at the restoration site should be examined to determine the strategy for buffer establishment. Strategies will differ for various pre-restoration conditions such as pasture, overgrown abandoned field, mid-succession forest, etc.

- *Identify Desirable Species:* Native tree and shrub species that thrive in riparian habitats in Pennsylvania should be used. These species should be identified in the restoration site and protected for their seed bank potential. Several native vines and shrubs (blackberry, Virginia creeper, and spicebush) can provide an effective ground cover during establishment of the buffer, though they should be selectively controlled to minimize herbaceous competition.
- *Identify Undesirable Species:* Consider utilizing undesirable species such as the black locust for their shade function during buffer establishment. Consider controlling invasive plants prior to buffer planting.
- *Identify Sensitive Species:* Since riparian zones are rich in wildlife habitat and wetland plant species to be aware of any rare, threatened or endangered plant (or animal) species.

5. Draw a Map of the Site (Data collection)

Prepare a sketch of the site that denotes important existing features, including stream width, length, streambank condition, adjacent land uses and stream activities, desired width of buffer, discharge pipes, obstructions, etc.

6. Create a Design that Meets Multiple Objectives

Ideally, the three-zone system should be incorporated into the design, in a flexible manner to obtain water quality and landowner objectives.

- *Consider landowner objectives:* Consider the current use of the buffer by the landowner, especially if the buffer will be protected in perpetuity. Consider linking the buffer to an existing (or planned) trail system.
- *Buffer width:* Riparian buffer areas do not have a fixed linear boundary, but vary in shape, width, and vegetative type and character. The function of the buffer (habitat, water quality, etc) is the overriding criterion in determining buffer width (Figure 1). Many factors including slope, soil type, adjacent land uses, floodplain, vegetative type, and

water shed condition influence what can be planted. The most commonly approved minimum buffer widths for water quality and habitat maintenance are 35 –100 feet. Buffers less than 35 feet do not protect aquatic resources long term.

Figure 1

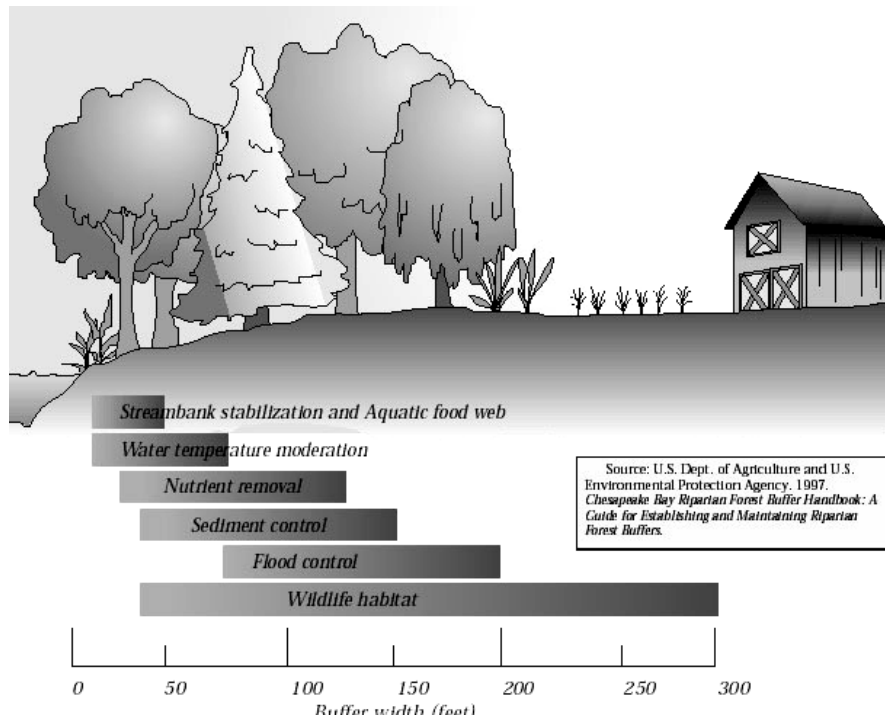

- *Consider costs:* The planting design (density, type, mix, etc.) will ultimately be based on the financial constraints of the project. See discussion below for estimating direct costs for planting and maintenance.
- *Choose the appropriate plants:* This manual encourages the use of native plants in stormwater management facilities. Since they are best suited to our local climate, native species have distinct genetic advantages over non-native species. Ultimately using native plants translates into greater survivorship with less replacement and maintenance which is a cost benefit to the landowner. Please refer to the plant list in Appendix B for a comprehensive list of native trees and shrubs available for stormwater management facility planting.

Plant Size: Choice of planting stock (seeds, container seedling, bare-root seedlings, plugs, etc.) is ultimately determined by funding resources. Larger material will generally cost more, although it will usually establish more rapidly.

7. Draw a Planting Plan

Planting Density: Trees should be planted at a density sufficient to provide 320 trees per acre at maturity. To achieve this density, approximately 436 (10 x 10 feet spacing) to 681 (8 x 8 feet spacing) trees per acre should be planted initially. Some rules of thumb for tree spacing and density based on plant size at installation:

Seedlings	6-10 feet spacing (~700 seedlings / acre)
Bare Root Stock	14-16 feet spacing (~200 plants / acre)
Larger & Container	16 – 18 feet spacing (~150 plants/acre)

Formula for Estimating Number of Trees and Shrubs:
 # Plants = length x width of corridor (ft) / 50 square feet

This formula assumes each tree will occupy an average of 50 sq. ft., random placement of plants approximately 10 feet apart, and mortality rate of up to 40% that can be absorbed by the growing forest system.

Alternatively, the adjacent table can be utilized to estimate the number of trees per acre needed for various methods of spacing.

Planting Layout: Given planting density and mix, drawing the planting plan is fairly straightforward. The plan can vary from a highly technical drawn to scale plan, or a simple line drawing of the site. Any plan must show the site with areas denoted for trees and shrub species with notes for plant spacing and buffer width.

Spacing (feet)	Trees (number)	Spacing (feet)	Trees (number)	Spacing (feet)	Trees (number)
2x2	10,890	7x9	691	12x15	242
3x3	4,840	7x10	622	12x18	202
4x4	2,722	7x12	519	12x20	182
4x5	2,178	7x15	415	12x25	145
4x6	1,815	8x8	681	13x13	258
4x7	1,556	8x9	605	13x15	223
4x8	1,361	8x10	544	13x20	168
4x9	1,210	8x12	454	13x25	134
4x10	1,089	8x15	363	14x14	222
5x5	1,742	8x25	218	14x15	207
5x6	1,452	9x9	538	14x20	156
5x7	1,245	9x10	484	14x25	124
5x8	1,089	9x12	403	15x15	194
5x9	968	9x15	323	15x20	145
5x10	871	10x10	436	15x25	116
6x6	1,210	10x12	363	16x16	170
6x7	1,037	10x15	290	16x20	136
6x8	908	10x18	242	16x25	109
6x9	807	11x11	360	18x18	134
6x10	726	11x12	330	18x20	121
6x12	605	11x15	264	18x25	97
6x15	484	11x20	198	20x20	109
7x7	889	11x25	158	20x25	87
7x8	778	12x12	302	25x25	70

8. Prepare Site Ahead of Time

Existing site conditions will determine the degree of preparation needed prior to planting. Invasive infestation and vegetative competition are extremely variable, and therefore must be considered in the planning stages. Site preparation should begin in the fall prior to planting. Enlist professional to determine whether use of chemical controls are necessary to prepare site for planting. Eliminate undesired species with either herbicide application (consult a professional) or physical removal. If utilizing a highly designed planting layout, mark site ahead of time with flags, spray paint, or other markers so that the appropriate plant is put in the right place.

9. Determine Maintenance Needs

An effective buffer restoration project should include management and maintenance guidelines, including a description of the allowable uses in the various zones of the buffer. Buffer

boundaries should be well defined with clear signs or markers. Weed control is essential for the survival and rapid growth of trees and shrubs, and can include any of the following:

- Organic mulch
- Weed control fabrics
- Shallow cultivation
- Pre-emergent herbicides
- Mowing

Non-chemical weed control methods are preferred since chemicals can easily enter the water system. If possible, avoid working in the riparian area between April 15 and August 15, the mating and newborn period for local wildlife.

Variations

See Applications

Applications

- **Forested Landscape**



- **Agricultural Landscape**



- **Suburban / Developing Landscape**

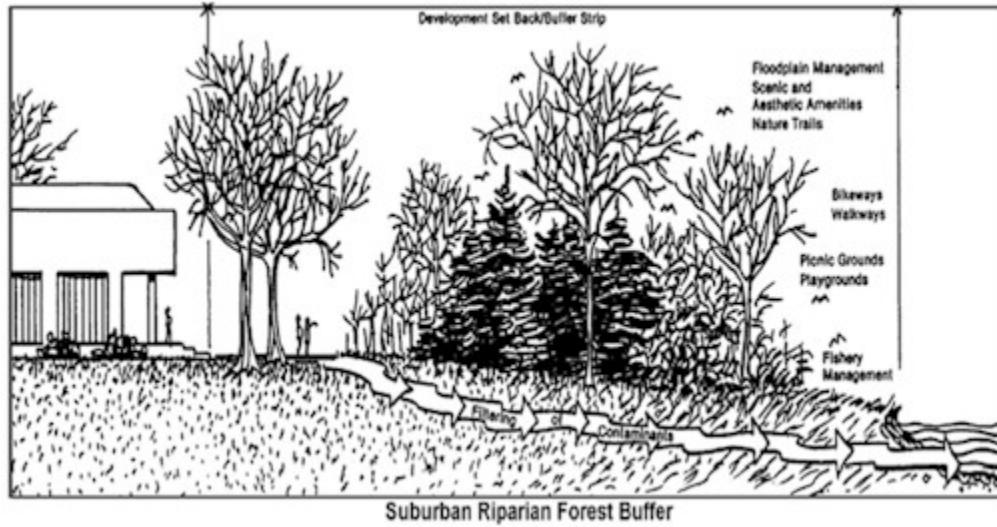

- **Urban Landscape**

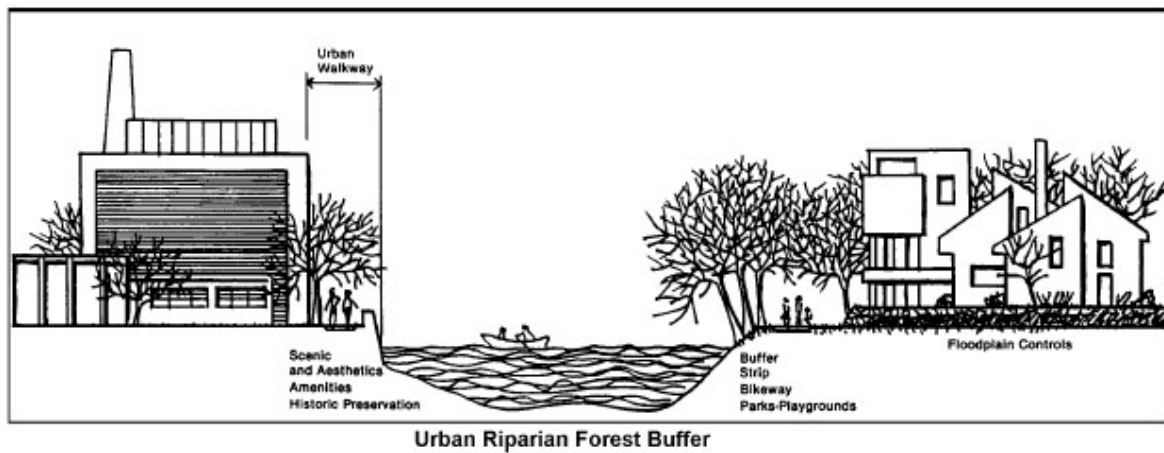

Design Considerations

The considerations listed below should all be taken into account during the planning stage. There are many potential threats to the long-term viability of riparian plant establishment and with proper foresight, these problems can be eliminated or addressed.

1. Deer Control

- a. Look for signs of high deer densities, including an overgrazed understory with a browse line 5-6 feet above the ground.

2. Tree Shelters

- a. Recommended for riparian plantings where deer predation or human intrusion may be a problem.
- b. Plastic tubes that fit over newly planted trees that are extremely successful in protecting seedlings.
- c. Protect trees from accidental strikes from mowing or trimming
- d. Create favorable microclimate for seedlings
- e. Secure with wooden stake and place netting over top of tree tube
- f. Remove tree shelters 2 to 3 years after plants emerge

3. Stream Buffer Fencing

- a. Deer can jump fences up to 10 feet high, preferring to go under barriers.
- b. Farm animals cause greatest damage to stream banks – consider permanent fencing like high-tensile smooth wire fencing or barbed fencing.
- c. The least expensive is 8 foot plastic fencing, which are effective against deer and easily repaired.

4. Vegetation

- a. Consider using plants that are able to survive frequent or prolonged flooding conditions. Plant trees that can withstand high water table conditions. Figure 5 shows tree species that fit into the moisture conditions of a streamside area.
- b. Soil disturbance can result in unanticipated infestation by invasive plants.

Figure 5. Sample Planting Recommendations According to Moisture Conditions

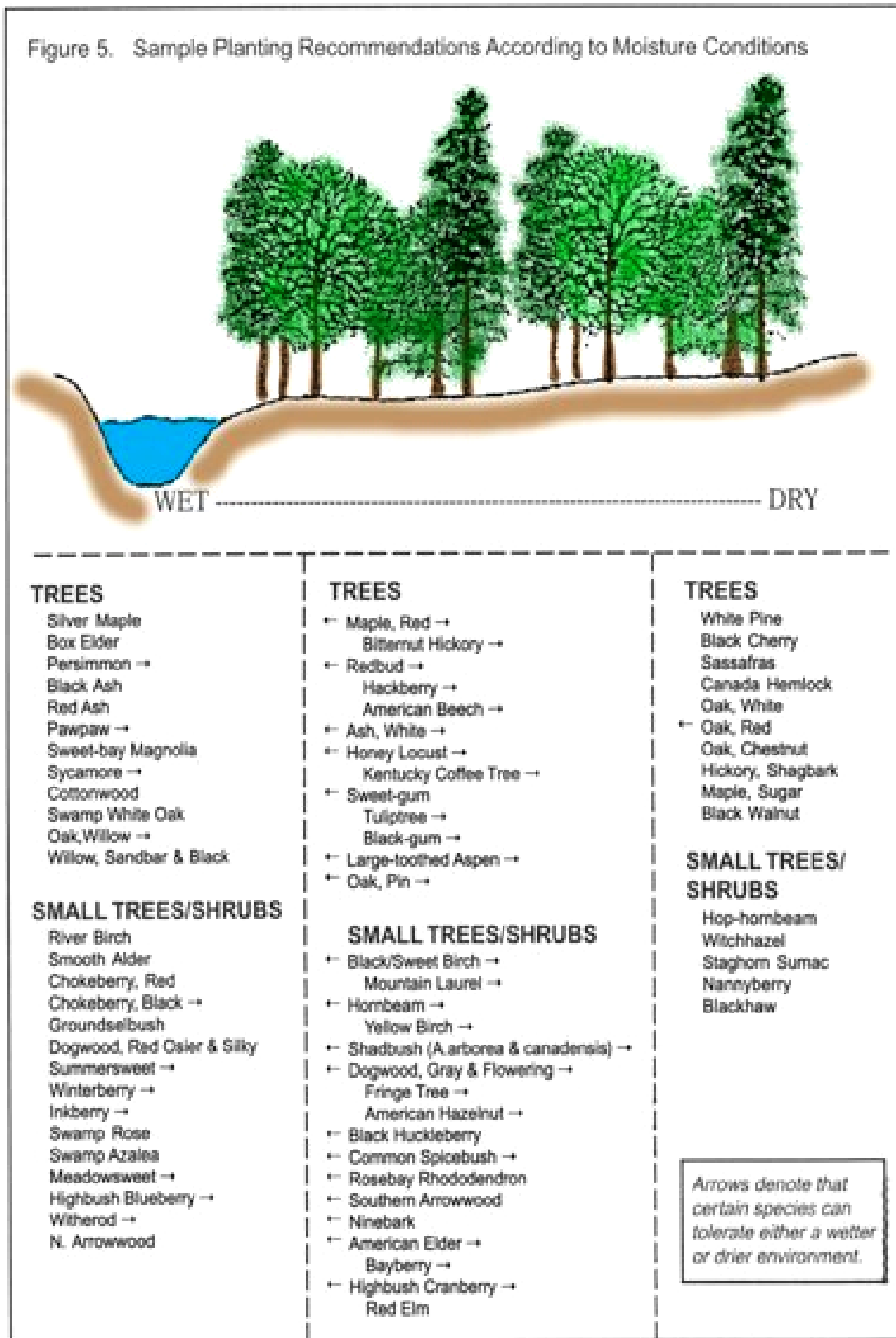

Construction Sequence

The PA Stream ReLeaf project provides a checklist that can substitute for a construction sequence for riparian buffer restoration. A slightly modified version follows:

1. SELECT SITE

- Confirm site is suitable for restoration
- Obtain landowner permission

2. ANALYSE SITE

- Evaluate site's physical conditions (soil attributes, geology, terrain)
- Evaluate site's vegetative features (desirable and undesirable species, native species, sensitive habitats)
- Sketch or map site feature

3. DESIGN BUFFER

- Consider landowner objectives in creating buffer design
- Determine desired functions of buffer in determining buffer width
- Match plant species to site conditions (hardiness zone, moisture, soil pH)
- Match plant Species to objectives of buffer functions (water quality, wildlife, recreation, etc.)
- Match plant sizes to meet budget limitations
- Develop sketch of planting plan

4. PREPARE SITE

- Eliminate undesirable species ahead of planting date
- Mark planting layout at the site
- Purchase plants and planting materials (mulch, tree shelters)

5. SITE PLAN SHOULD INCLUDE:

- Site map with marked planting zones
- Plant species list
- Planting directions (spacing, pattern of planting)
- Equipment/tool list
- Site preparation directions
- Maintenance schedule

6. PLANTING DAY

- Keep plants moist and shaded
- Provide adequate number of tools
- Document with photos of site during planting

7. SITE MAINTENANCE (additional information below)

- Assign responsibilities watering, weeding, mowing, and maintenance
- Monitor site regularly for growth and potential problems

Maintenance Issues

The riparian buffer is subject to many threats, including:

- Browsing
- Invasion by exotic species
- Competition for nutrients by adjacent herbaceous vegetation
- Human disturbance

Proper awareness of these issues is critical to ensure the long-term effectiveness of a restored riparian buffer.

The most critical period during buffer establishment is maintenance of the newly planted trees during canopy closure, typically the first 3 to 5 years. Ongoing maintenance practices are necessary for both small seedlings and larger plant materials. Maintenance and monitoring plans should be prepared for the specific site and caretakers need to be advised of required duties during the regular maintenance period.

Maintenance measures that should be performed regularly:

Watering

- Plantings need deep regular watering during the first growing season, either natural watering via rainfall, or planned watering, via caretaker.
- Planting in the fall increases the likelihood of sufficient rain during planting establishment.

Mulching

- Mulch will assist in moisture retention in the root zone of plantings, moderate soil temperature, provide some weed suppression, and retard evaporation
- Use coarse, organic mulch that is slow to decompose in order minimize repeat application
- Apply 2-4 inch layer, leaving air space around tree trunk to prevent fungus growth.
- Use combination of woodchips, leaves, and twigs that are stockpiled for six months to a year.

Weed control

- Weed competition limits buffer growth and survival, therefore weeds should be controlled by either herbicides, mowing, or weed mats:

Herbicides

This is a short-term maintenance technique (2-3 years) that is generally considered less expensive and more flexible than mowing, and will result in a quicker establishment of the buffer. Herbicide use is regulated by the PA Department of Agriculture. Proper care should be taken to ensure that proximity to water features is considered.

Mowing

Mowing controls the height of the existing grasses, yet increases nutrient uptake, therefore competition for nutrients will persist until the canopy closure shades out lower layers. A planting layout similar to a grid format will facilitate ease of mowing yet yield an unnaturally spaced community. Mowing may result in strikes on the trunk unless protective measures are utilized. Mowing should occur twice each growing season. Mower height should be set between 8 –12 inches.

Weed Mats

Weed mats are geo-textile fabrics that are used to suppress weed growth around newly planted vegetation by providing shade and preventing seed deposition. Weed mats are installed after planting, and should be removed once the trees have developed a canopy that will naturally shade out weeds.

Deer damage

- Deer will browse all vegetation within reach, generally between 5-6 feet above the ground
- Approaches to minimize damage include: 1) selecting plants that deer do not prefer (ex. Paper Birch, Beech, Ash, Common Elderberry) 2) homemade deer repellants 3) tree shelters

Tree shelters

- Repair broken stakes
- Tighten stake lines
- Straighten leaning tubes
- Clean debris from tube
- Remove netting as tree grows
- Remove when tree is approximately 2 inches wide

Invasive Plants

- Monitor restoration sight regularly for any signs of invasive plants.
- Appendix B contains common invasive plants found in Pennsylvania.
- Choice of control method is based on a variety of considerations, but falls into three general categories:
 - Mechanical
 - Mechanical with application of herbicide
 - Herbicide

Special Maintenance Considerations

Riparian buffer restoration sites should be monitored to maximize wildlife habitat and water quality benefits, and to discover emerging threats to the project. During the first four years, the new buffer should be monitored four times annually (February, May, August, and November are recommended) and inspected after any severe storm. Repairs should be made as soon as possible.

Depending on restoration site size, the buffer area should be sampled to approximate survival rate. Data derived should consider survival of the planted material and natural regeneration to determine if in-fill planting should occur to supplement plant density.

Survival rates of at least 70% are deemed to be successful. Calculate percent survival by the following equation:

$$(\# \text{ of live plants} / \# \text{ of installed plants}) 100 = \% \text{ survival}$$

Cost Issues

Establishment and maintenance costs should be considered up front in the riparian buffer plan design. Installing a forest riparian buffer involves site preparation, tree planting, second year reinforcement planting, and additional maintenance. Both the USDA Riparian Handbook and the PADEP/PADCNR Stream ReLeaf Forest Buffer Toolkit utilize a basic outline for estimating costs for establishment and maintenance:

Costs may fluctuate based on numerous variables including whether or not volunteer labor is utilized, whether plantings and other supplies are donated or provided at a reduced cost.

Specifications

The USDA Forest Service developed a riparian forest buffer specification, which outlines three distinct zones and establishes the minimally acceptable requirements for reforestation by landowners.

Definition

An area of trees and other vegetation located in areas adjoining and upgradient from surface water bodies and designed to intercept surface runoff, wastewater, subsurface flow, and deeper groundwater flows from upland sources for the purpose of removing or buffering the effects of associated nutrients, sediment, organic matter, pesticides, or other pollutants prior to entry into surface waters and ground water recharge areas.

Scope

This specification establishes the minimally acceptable requirements for the reforestation of open lands, and renovation of existing forest to be managed as Riparian Forest Buffers for the purposes stated.

Purpose

To remove nutrients, sediment, animal-derived organic matter, and some pesticides from surface runoff, subsurface flow, and near root zone groundwater by deposition, absorption, adsorption, plant uptake, denitrification, and other processes, thereby reducing pollution and protecting surface water and groundwater quality.

Conditions Where Practice Applies

Subsurface nutrient buffering processes, such as denitrification, can take place in the soil wherever carbon energy, bacteria, oxygen, temperature, and soil moisture is adequate. Nutrient uptake by plants occurs where the water table is within the root zone. Surficial filtration occurs anywhere surface vegetation and forest litter are adequate.

The riparian forest buffer will be most effective when used as a component of a sound land management system including nutrient management and runoff, and sediment and erosion control practices. Use of this practice without other nutrient and runoff, sediment and erosion control practices can result in adverse impacts on buffer vegetation and hydraulics including high maintenance costs, the need for periodic replanting, and the carrying of excess nutrients and sediment through the buffer by concentrated flows.

This practice applies on lands:

1. adjacent to permanent or intermittent streams which occur at the lower edge of upslope cropland, grassland or pasture;

2. at the margins of lakes or ponds which occur at the lower edge of upslope cropland, grassland or pasture;
3. at the margin of any intermittent or permanently flooded, environmentally sensitive, open water wetlands which occur at the lower edge of upslope cropland, grassland or pasture;
4. on karst formations at the margin of sinkholes and other small groundwater recharge areas occurring on cropland, grassland, or pasture.

Note: In high sediment production areas (8-20 in./100 yrs.), severe sheet, rill, and gully erosion must be brought under control on upslope areas for this practice to function correctly.

Riparian Buffer Installation Costs - Estimation per Acre

	Cost, ea.	Number	Cost, Total
Phase 1: Establishment			
<i>Preparation</i>			
Light site preparation (mow, disking)	-	-	\$ 12.00
<i>Planting</i>			
Tree Seedlings (12" - 18" Hardwoods)	\$ 1.15	430	\$ 494.50
Tree Shelters (optional)	\$ 5.00	430	\$ 2,150.00
Fencing (1 ac = 282 ft) (optional)			\$ 564.00
Subtotal			\$ 3,220.50
Phase 2: Maintenance			
<i>Reinforcement Planting</i>			
Tree Seedlings in Year 2	\$ 1.15	50	\$ 57.50
Herbicide Treatment (optional)			\$ 54.00
Mowing (optional)			\$ 12.00
Subtotal			\$ 123.50
Total Costs, no options			\$ 564.00
Total Costs, with options			\$ 3,344.00

Design Criteria

Riparian Forest Buffers

Riparian forest buffers will consist of three distinct zones and be designed to filter surface runoff as sheet flow and downslope subsurface flow, which occurs as shallow groundwater. For the purposes of these buffer strips, shallow groundwater is defined as: saturated conditions which occur near or within the root zone of trees, and other woody vegetation and at relatively shallow depths where bacteria, oxygen, and soil temperature contribute to denitrification. Streamside Forest Buffers will be designed to encourage sheet flow and infiltration and impede concentrated flow.

Zone 1

Location

Zone 1 will begin at the top of the streambank and occupy a strip of land with a fixed width of fifteen feet measured horizontally on a line perpendicular to the streambank.

Purpose

The purpose of Zone 1 is to create a stable ecosystem adjacent to the water's edge, provide soil/water contact area to facilitate nutrient buffering processes, provide shade to moderate and stabilize water temperature encouraging the production of beneficial algal forms, and to contribute necessary detritus and large woody debris to the stream ecosystem.

Requirements

Runoff and wastewater to be buffered or filtered by Zone 1 will be limited to sheet flow or subsurface flow only. Concentrated flows must be converted to sheet flow or subsurface flows prior to entering Zone 1. Outflow from subsurface drains must not be allowed to pass through the riparian forest in pipes or tile, thus circumventing the treatment processes. Subsurface drain outflow must be converted to sheet flow for treatment by the riparian forest buffer, or treated elsewhere in the system prior to entering the surface water.

Dominant vegetation will be composed of a variety of native riparian tree and shrub species and such plantings as necessary for streambank stabilization during the establishment period. A mix of species will provide the prolonged stable leaf fall and variety of leaves necessary to meet the energy and pupation needs of aquatic insects.

Large overmature trees are valued for their detritus and large woody debris. Zone 1 will be limited to bank stabilization and removal of potential problem vegetation. Occasional removal of extreme high value trees may be permitted where water quality values are not compromised. Logging and other overland equipment shall be excluded except for stream crossings and stabilization work.

Livestock will be excluded from Zone 1 except for designed stream crossings.

Zone 2

Location

Zone 2 will begin at the edge of Zone 1 and occupy an additional strip of land with a minimum width of 60 feet measured horizontally on a line perpendicular to the streambank. Total minimum width of Zones 1 & 2 is therefore 75 feet. Note that this is the minimum width of Zone 2 and that the width of Zone 2 may have to be increased as described in the section “Determining the Total Width of Buffer” to create a greater combined width for Zones 1 & 2.

Purpose

The purpose of Zone 2 is to provide necessary contact time and carbon energy source for buffering processes to take place, and to provide for long term sequestering of nutrients in the form of forest trees. Outflow from subsurface drains must not be allowed to pass through the riparian forest in pipe or tile, thus circumventing the treatment processes. Subsurface drain outflow must be converted to sheet flow for treatment by the riparian forest buffer, or treated elsewhere in the system prior to entering the surface water.

Requirements

Runoff and wastewater to be buffered or filtered by Zone 2 will be limited to sheet flow or subsurface flow only. Concentrated flows must be converted to sheet flow or subsurface flows prior to entering Zone 2.

Predominant vegetation will be composed of riparian trees and shrubs suitable to the site, with emphasis on native species, and such plantings as necessary to stabilize soil during the establishment period. Nitrogen-fixing species should be discouraged where nitrogen removal or buffering is desired. Species suitability information should be developed in consultation with state and federal forestry agencies, Natural Resources Conservation Service, and USDI Fish and Wildlife Service.

Specifications should include periodic harvesting and timber stand improvement (TSI) to maintain vigorous growth and leaf litter replacement, and to remove nutrients and pollutants sequestered in the form of wood in tree boles and large branches. Management for wildlife habitat, aesthetics, and timber are not incompatible with riparian forest buffer objectives as long as shade levels and production of leaf litter, detritus, and large woody debris are maintained. Appropriate logging equipment recommendations shall be determined in consultation with the state and federal forestry agencies.

Livestock shall be excluded from Zone 2 except for necessary designed stream crossings.

Zone 3

Location

Zone 3 will begin at the outer edge of Zone 2 and have a minimum width of 20 feet. Additional width may be desirable to accommodate land-shaping and mowing machinery. Grazed or ungrazed grassland meeting the purpose and requirements stated below may serve as Zone 3.

Purpose

The purpose of Zone 3 is to provide sediment filtering, nutrient uptake, and the space necessary to convert concentrated flow to uniform, shallow, sheet flow through the use of techniques such as grading and shaping, and devices such as diversions, basins, and level lip spreaders.

Requirements

Vegetation will be composed of dense grasses and forbs for structure stabilization, sediment control, and nutrient uptake. Mowing and removal of clippings are necessary to recycle sequestered nutrients, promote vigorous sod, and control weed growth.

Vegetation must be maintained in a vigorous condition. The vegetative growth must be hayed, grazed, or otherwise removed from Zone 3. Maintaining vigorous growth of Zone 3 vegetation must take precedence and may not be consistent with wildlife needs.

Zone 3 may be used for controlled intensive grazing when conditions are such that earthen water control structures will not be damaged.

Zone 3 may require periodic reshaping of earth structures, removal or grading of accumulated sediment, and reestablishment of vegetation to maintain effectiveness of the riparian buffer.

Determining Need For Protection

Buffers should be used to protect any body of water which will not be:

- treated by routing through a natural or artificial wetland determined to be adequate treatment;
- treated by converting the flow to sheet flow and routing it through a forest buffer at a point lower in the watershed.

Determining Total Width of the Buffer

Note that while not specifically addressed, slope and soil permeability are components of the following buffer width criteria.

Each of the following criteria is based on methods developed, or used by persons conducting research on riparian forests.

Streamside Buffers

The minimum width of streamside buffer areas can be determined by any number of methods suitable to the geographic area.

1. Based on soil hydrologic groups as shown in the county soil survey report, the width of Zone 2 will be increased to occupy any soils designated as Hydrologic Group D and those soils of Hydrologic Group C which are subject to frequent flooding. If soils of Hydrologic Groups A or B occur adjacent to intermittent or perennial streams, the combined width of Zones 1 & 2 may be limited to the 75 foot minimum.
2. Based on area, the width of Zone 2 should be increased to provide a combined width of Zones 1 & 2 equal to one third of the slope distance from the streambank to the top of the pollutant source area. The effect is to create a buffer strip between field and stream which occupies approximately one third of the source area.

3. Based on the Land Capability Class of the buffer site as shown in the county soil survey, the width of Zone 2 should be increased to provide a combined width of Zones 1 & 2 as shown below.

Capability Class	Buffer Width
Cap. I, II e/s, V	75'
Cap. III e/s, IV e/s	100'
Cap. VI e/s, VII e/s	150'

Pond and Lake-Side Buffer Strips

The area of pond or lake-side buffer strips should be at least one-fifth the drainage area of the cropland and pastureland source area. The width of the buffer strip is determined by creating a uniform width buffer of the required area between field and pond. Hydrologic Group and Capability Class methods of determining width remain the same as for streamside buffers. Minimum widths apply in all cases.

Environmentally Sensitive Wetlands

Some wetlands function as nutrient sinks. When they occur in fields or at field margins, they can be used for renovation of agricultural surface runoff and/or drainage. However, most wetlands adjoining open water are subject to periodic flushing of nutrient-laden sediments and, therefore, require riparian buffers to protect water quality.

Where open water wetlands are roughly ellipsoid in shape, they should receive the same protection as ponds.

Where open water wetlands exist in fields as seeps along hillslopes, buffers should consist of Zones 1, 2 & 3 on sides receiving runoff and Zones 1 & 3 on the remaining sides. Livestock must be excluded from Zones 1 & 2 at all times and controlled in Zone 3. Where Zones 1 & 3 only are used, livestock must be excluded from both zones at all times, but hay removal is desirable in Zone 3.

Vegetation Selection

Zone 1 & 2 vegetation will consist of native streamside tree species on soils of Hydrologic Groups D and C and native upland tree species on soils of Hydrologic Groups A and B.

Deciduous species are important in Zone 2 due to the production of carbon leachate from leaf litter which drives bacterial processes that remove nitrogen, as well as, the sequestering of nutrients in the growth processes. In warmer climates, evergreens are also important due to the potential for nutrient uptake during the winter months. In both cases, a variety of species is important to meet the habitat needs of insects important to the aquatic food chain.

Zone 3 vegetation should consist of perennial grasses and forbs.

Species recommendations for vegetated buffer areas depend on the geographic location of the buffer. Suggested species lists should be developed in collaboration with appropriate state and federal forestry agencies, the Natural Resources Conservation Service, and the USDI Fish and Wildlife Service. Species lists should include trees, shrubs, grasses, legumes, forbs, as well as site preparation techniques. Fertilizer and lime, helpful in establishing buffer vegetation, must be used with caution and are not recommended in Zone 1.

Maintenance Guidelines

General

Buffers must be inspected annually and immediately following severe storms for evidence of sediment deposit, and erosion, or concentrated flow channels. Prompt corrective action must be taken to stop erosion and restore sheet flow.

The following should be avoided within the buffer areas: excess use of fertilizers, pesticides, or other chemicals; vehicular traffic or excessive pedestrian traffic; and removal or disturbance of vegetation and litter inconsistent with erosion control and buffering objectives.

Zone 1 vegetation should remain undisturbed except for removal of individual trees of extremely high value or trees presenting unusual hazards such as potentially blocking culverts.

Zone 2 vegetation, undergrowth, forest floor, duff layer, and leaf litter shall remain undisturbed except for periodic cutting of trees to remove sequestered nutrients; to maintain an efficient filter by fostering vigorous growth; and for spot site preparation for regeneration purposes. Controlled burning for site preparation, consistent with good forest management practices, could also be used in Zone 2.

Zone 3 vegetation should be mowed and the clippings removed as necessary to remove sequestered nutrients and promote dense growth for optimum soil stabilization. Hay or pasture uses can be made compatible with the objectives of Zone 3.

Zone 3 vegetation should be inspected twice annually, and remedial measures taken as necessary to maintain vegetation density and remove problem sediment accumulations.

Stable Debris

As Zone 1 reaches 60 years of age, it will begin to produce large stable debris. Large debris, such as logs, create small dams which trap and hold detritus for processing by aquatic insects, thus adding energy to the stream ecosystem, strengthening the food chain, and improving aquatic habitat. Wherever possible, stable debris should be conserved.

Where debris dams must be removed, try to retain useful, stable portions which provide detritus storage.

Deposit removed material a sufficient distance from the stream so that it will not be refloated by high water.

Planning Considerations

1. Evaluate the type and quantity of potential pollutants that will be derived from the drainage area.
2. Select species adapted to the zones based on soil, site factors, and possible commercial goals such as timber and forage.

3. Plan to establish trees early in the dormant season for maximum viability.
4. Be aware of visual aspects and plan for wildlife habitat improvement if desired.
5. Consider provisions for mowing and removing vegetation from Zone 3. Controlled grazing may be satisfactory in Zone 3 when the filter area is dry and firm.

References

Natural Resources Conservation Service. 1997. USDA Natural Resources Conservation Practice Standard Riparian Forest Buffer. USDA Natural Resources Conservation Service.

Palone, R.S. and A.H. Todd (editors.) 1997. Chesapeake Bay Riparian Handbook: A Guide for Establishing and Maintaining Riparian Forest Buffers. USDA Forest Service. NA-TP-02-97. Radnor, PA. <http://www.chesapeakebay.net/pubs/subcommittee/nsc/forest> or order from: U.S. EPA Chesapeake Bay Program. 410 Severn Ave. Suite 109. Annapolis, MD. 1-800-968-7229.

PA Department of Environmental Protection. 1998. *Pennsylvania Stream ReLeaf – Forest Buffer Toolkit*, <http://www.dep.state.pa.us/dep/deputate/watermgt/WC/Subjects/StreamReLeaf/default.htm>

Tjaden, R.L. and G.M. Weber. 1997. An Introduction to the Riparian Forest Buffer. Maryland Cooperative Extension Fact Sheet 724. College Park, MD. 2 pages. <http://www.riparianbuffers.umd.edu/PDFs/FS724.pdf>.

Tjaden, R.L. and G.M. Weber. 1997. Riparian Buffer Systems. Maryland Cooperative Extension Fact Sheet 733. College Park, MD. 2 pages. <http://www.riparianbuffers.umd.edu/PDFs/FS733.pdf>.

BMP 6.7.2: Landscape Restoration



Landscape Restoration is the general term used for actively sustainable landscaping practices that are implemented outside of riparian (or other specially protected) buffer areas. Landscape Restoration includes the restoration of forest (i.e. reforestation) and/or meadow and the conversion of turf to meadow. In a truly sustainable site design process, this BMP should be considered only after the areas of development that require landscaping and/or revegetation are minimized. The remaining areas that do require landscaping and/or revegetation should be driven by the selection and use of vegetation (i.e., native species) that does not require significant chemical maintenance by fertilizers, herbicides, and pesticides..

<ul style="list-style-type: none"> ▪ Minimize traditional turf lawn area ▪ Maximize landscape restoration area planted with native vegetation ▪ Protect landscape restoration area during construction ▪ Prevent post-construction erosion through adequate stabilization ▪ Minimize fertilizer and chemical-based pest control programs ▪ Creates and maintains porous surface and healthy soil. ▪ Minimize mowing (two times per year) ▪ Reduced maintenance cost compared to lawn 	<p>Commercial: Yes Ultra Urban: Limited Industrial: Yes Retrofit: Yes Highway/Road: Yes</p>
	<p><u>Stormwater Functions</u></p> <p>Volume Reduction: Low/Med. Recharge: Low/Med. Peak Rate Control: Low/Med. Water Quality: Very High</p>
	<p><u>Water Quality Functions</u></p> <p>TSS: 85% TP: 85% NO3: 50%</p>

Other Considerations

- Soil investigation recommended
- Soil restoration may be necessary

Description

In an integrated stormwater management plan, the landscape is a vital factor, not only in sustaining the aesthetic and functional resources of a site, but also in mitigating the volume and rate of stormwater runoff.

Sustainable landscaping, or Landscape Restoration, is an effective method of improving the quality of site runoff. This often overlooked BMP includes the restoration of forest and/or meadow or the conversion of turf to meadow.



Landscape Restoration involves the careful selection and use of vegetation that does not require significant chemical maintenance by fertilizers, herbicides and pesticides. Implicit in this BMP is the assumption that native species have the greatest tolerance and resistance to pests and require less fertilization and chemical application than do nonnative species. Furthermore, since native grasses and other herbaceous materials often require less intensive maintenance efforts (i.e. mowing or trimming), their implementation on a site results in less biomass produced.

Native species are customarily strong growers with stronger and denser root and stem systems, thereby generating less runoff. If the objective is revegetation with woodland species, the longer-term effect is a significant reduction in runoff volumes, with increases in infiltration, evapotranspiration, and recharge, when contrasted with a conventional lawn planting. Peak rate reduction also is achieved. Similarly, meadow reestablishment is also more beneficial than a conventional lawn planting, although not so much as the woodland landscape. Again, these benefits are long term in nature and will not be forthcoming until the species have had an opportunity to grow and mature (one advantage of the meadow is that this maturation process requires considerably less time than a woodland area). Native grasses also tend to have substantially deeper roots and more root mass than turf grasses, which results in:

- A greater volume of water uptake (evapotranspiration)
- Improved soil conditions through organic material and macropore formation
- Provide for greater infiltration

Landscape architects specializing in the local plant community are usually able to identify a variety of species that meet these criteria. Other sources of advice may be county conservation districts, watershed associations and other conservation groups. As the selection of such materials begins at the conceptual design stage, where lawns are eliminated or avoided altogether and landscaping species selected, Landscape Restoration can generally result in a site with reduced runoff volume and rate, as well as significant nonpoint source load reduction/prevention.

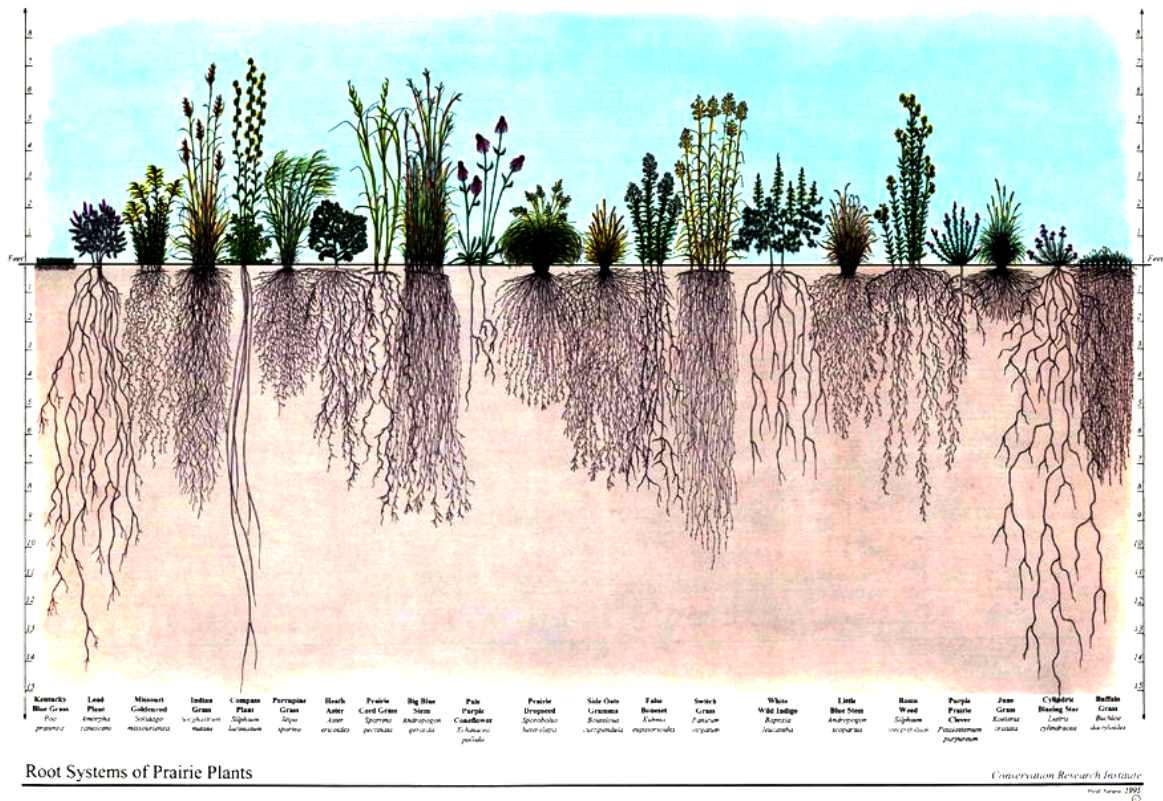

Landscape Restoration can improve water quality by minimizing application of fertilizers and pesticides/herbicides. Given the high rates of chemical application which have been documented at newly created lawns for both residential and nonresidential land uses, eliminating the need for chemical application is important for water quality. Of special importance here is the reduction in fertilization and nitrate loadings. For example, Delaware's *Conservation Design for Stormwater Management* lists multiple studies that document high fertilizer application rates, including both nitrogen and phosphorus, in newly created landscapes in residential and nonresidential land developments. Expansive lawn areas in low density single-family residential subdivisions as well as large office parks typically receives intensive chemical application, both fertilization and pest control, which can exceed application rates being applied to agricultural fields. Avoidance of this nonpoint pollutant source is an important water quality objective.

Variations

- Meadow
- No-mow lawn area
- Woodland restoration
- Removal of existing lawn to reduce runoff volume
- Buffers between lawn areas and wetlands or stream corridors
- Replacement of “wet” lawn areas difficult to mow
- Replacement of hard to maintain lawns under mature trees

Applications

- Forested Landscape/Restoration
- Suburban / Developing Landscape
- Urban Landscape
- Meadow Restoration
- Conversion of Turf to Meadow

Design Considerations

1. The recommended guidelines for Landscape Restoration are very closely related to those of Riparian Buffer Restoration (RBR) (BMP 6.7.1). Specifically, Landscape Restoration overlaps with the guidelines for Zones 2 and 3 in typical RBR. As with RBR, it is essential for successful Landscape Restoration that site conditions be well understood, objectives of the landowner considered, and the appropriate plants chosen for the site. These are all tasks that should be completed in the early planning stages of a project. For a summary of the nine steps recommended for the planning stages of a restoration project, see BMP 6.7.1- Riparian Buffer Restoration. Included in this nine-step process are: analysis of site soils/natural vegetative features/habitat significance/topography/etc., determination of restoration suitability, and site preparation.
2. In those sites where soils have been disturbed or determined inadequate for restoration (based on analysis), soil amendments are needed. Soil amendment and restoration is the process of restoring compromised soils by subsoiling and/or adding a soil amendment, such as compost, for the purpose of reestablishing its long-term capacity for infiltration and pollution removal. For more information on restoring soils, see BMP 6.7.3 Soil Amendments and Restoration.
3. “Native species” is a broad term. Different types of native species landscapes may be created, from meadow to woodland areas, obviously requiring different approaches to planting. A native landscape may take several forms in Pennsylvania, ranging from reestablishment of woodlands with understory plantings to reestablishment of meadow. It should be noted that as native landscapes grow and mature, the positive stormwater benefits relating to volume control and peak rate control increase. So, unlike highly maintained turf lawns, these landscapes become much more effective in reducing runoff volumes and nonpoint source pollutants over time.
4. Minimizing the extent of lawn is one of the easiest and most effective ways of improving water quality. Typical (i.e. compacted) lawns on gentle slopes can produce almost as much runoff as pavement. In contrast to turf, “natural forest soils with similar overall slopes can store up to 50 times more precipitation than neatly graded turf.” (Arendt, Growing Greener, pg. 81) The first step in sustainable site design is to limit the development footprint as much as possible, preserving natural site features, such as vegetation and topography. If lawn areas are desired in certain areas of a site, they should be confined to those areas with slopes less than 6%.



5. Meadow restoration may be used alone or in combination with a forest restoration. The native meadow landscape provides a land management alternative that benefits stormwater management by reducing runoff volume and nonpoint source pollutant transport. Furthermore, meadow landscapes vastly reduce the need for maintenance, as they do not require frequent mowing during the growing season. Because native grasses and flowers are almost exclusively perennials, properly installed meadows are a self-sustaining plant community that will return year after year.

Meadows can be constructed as a substitute to turf on the landscape, or they can be created as a buffer between turf and forest. In either situation, the meadow restoration acts to reduce runoff as well as reduce erosion and sedimentation. Meadow buffers along forests also help reduce off-trail pedestrian traffic in order to avoid creating paths which can further concentrate stormwater.

The challenge in restoring meadow landscapes is a lack of effective establishment and maintenance methods. Native grasses and flowers establish more slowly than weeds and turf grass. Therefore, care must be taken when creating meadow on sites where weed or other vegetative communities are well established. It may take a year or more to prepare the site and to get weeds under control before planting. Erosion prone sites should be planted with a nurse crop (such as annual rye) for quick vegetation establishment to prevent seed and soil loss. Steep slopes and intermittent water courses should be stabilized with erosion blankets, selected to mitigate expected runoff volumes and velocities. Additionally, seed quality is extremely important to successful establishment. There is tremendous variation among seed suppliers, seeds should be chosen with a minimum percent of non-seed plant parts.

6. Conversion of turf grass areas to meadow is relatively simple and has enormous benefits for stormwater management. Though turf is inexpensive to install, the cost of maintenance to promote an attractive healthy lawn is high (requiring mowing, irrigation, fertilizer, lime and



herbicides) and its effects are detrimental to water quality. Turf areas are good candidates for conversion to meadow as they typically have lower density of weed species. The conversion of turf to meadow requires that all turf be eliminated before planting, and care must be taken to control weed establishment prior to planting.

7. Forest restoration includes planting of appropriate tree species (small saplings) with quick establishment of an appropriate ground cover around the trees in order to stabilize the soil and prevent colonization of invasive species. Reforestation can be combined with other volume control BMPs such as retentive berming, vegetated filter strips and swales.

Plant selection should mimic the surrounding native vegetation and expand on the native species composition already found on the site. A mixture of native trees and shrubs is recommended and should be planted once a ground cover is established.

8. In terms of woodland areas, DCNR’s *Conservation Design for Stormwater Management* states, “...a mixture of young trees and shrubs is recommended.... Tree seedlings from 12 to 18 inches in height can be used, with shrubs at 18 to 24 inches. Once a ground cover crop is established (to offset the need for mowing), trees and shrubs should be planted on 8-foot centers, with a total of approximately 430 trees per acre. Trees should be planted with tree shelters to avoid browse damage in areas with high deer populations, and to encourage more rapid growth.” (p.3-50).



Initial watering and weekly watering during dry periods may be necessary during the first growing season. As tree species grow larger, both shrubs and ground covers recede and yield to the more dominant tree species. The native tree species mix of small inexpensive saplings should be picked for variety and should reflect the local forest communities. Annual mowing to control invasives may be necessary, although the quick establishment of a strong-growing ground cover can be effective in providing invasive control. Native meadow planting mixes also are available. A variety of site design factors may influence the type of vegetative community that is to be planned and implemented. In so many cases, the “natural” vegetation of Pennsylvania’s communities is, of course, woodland.

9. Ensure adequate stabilization. Adequate stabilization is extremely important as native grasses, meadow flowers, and woodlands establish more slowly than turf. Stabilization can be achieved for forest restoration by establishing a ground cover before planting of trees and shrubs. When creating meadows, it may be necessary to plant a fast growing nurse crop with meadow seeds for quick stabilization. Annual rye can be planted in the fall or spring with meadow seeds and will establish quickly and usually will not present a competitive problem. Erosion prone sites should be planted with a nurse crop and covered with weed-free straw mulch, while steep slopes and areas subject to runoff should be stabilized with erosion control blankets suitable for the expected volume and velocity of runoff.

Volume Reduction Calculations and Peak Rate Mitigation

Areas designated for landscape restoration should be considered as “Meadow, good condition” in stormwater calculations.

Water Quality Improvement

See Section 8 for Water Quality Improvement methodology, which addresses pollutant removal effectiveness of this BMP.

Construction Sequence

Forest restoration installation follows closely the procedure outlined in BMP 6.7.1- Riparian Buffer Restoration. Refer to BMP 6.7.1 for detailed information, with the understanding that species selection for upland forest restoration will differ from that for riparian restoration.

Meadow installation should proceed as follows:

1. SELECT SITE

- Confirm site is suitable for restoration, should be sunny, open and well-ventilated. Meadow plants require at least a half a day of full sun.
- Obtain landowner permission

2. ANALYZE SITE

- Evaluate site’s physical conditions (soil attributes, geology, terrain)
- Evaluate site’s vegetative features (desirable and undesirable species, native species, sensitive habitats). Good candidates for meadow plantings include areas presently in turf, cornfields, soybean fields, alfalfa fields and bare soils from new construction.
- Areas with a history of heavy weed growth may require a full year or longer to prepare for planting.
- Beware of residual herbicides that may have been applied to agricultural fields. Always check the herbicide history of the past 2-3 years and test the soils if in doubt.

3. PLANT SELECTION

- Select plants that are well adapted to the specific site conditions. Meadow plants must be able to out compete weed species in the first few years as they become established.

4. PREPARE SITE

- All weeds or existing vegetation must be eliminated prior to seeding.
- Perennial weeds may require year long smothering, repeated sprayings with herbicides, or repeated tillage with equipment that can uproot and kill perennial weeds.

5. PLANTING DAY

- Planting can take place from Spring thaw through June 30 or from September 1 through soil freeze-up (“dormant seeding”)
- Planting in July and August is generally not recommended due to the frequency of drought during this time.
- Seeding can be accomplished by a variety of methods: no-till seeder for multi-acre planting; broadcast seeder; hand broadcast for small areas of one acre or less.
- Seed quality is critical and a seed mix should be used with a minimum percentage of non-seed plant parts.

6. SITE MAINTENANCE (additional information below)

- Assign responsibilities for watering, weeding, mowing, and maintenance
- Monitor site regularly for growth and potential problems

Maintenance Issues

Meadows and Forests are low maintenance but not “no maintenance”. They usually require more frequent maintenance in the first few years immediately following installation.

Forest restoration areas planted with a proper cover crop can be expected to require annual mowing in order to control invasives. Application of a carefully selected herbicide (Roundup or similar glyphosate herbicide) around the protective tree shelters/tubes may be necessary, reinforced by selective cutting/manual removal, if necessary. This initial maintenance routine is necessary for the initial 2 to 3 years of growth and may be necessary for up to 5 years until tree growth and tree canopy begins to form, naturally inhibiting weed growth (once shading is adequate, growth of invasives and other weeds will be naturally prevented, and the woodland becomes self-maintaining). Review of the new woodland should be undertaken intermittently to determine if replacement trees should be provided (some modest rate of planting failure is usual).

Meadow management is somewhat more straightforward; a seasonal mowing or burning may be required, although care must be taken to make sure that any management is coordinated with essential reseeding and other important aspects of meadow reestablishment. In the first year weeds must be carefully controlled and consistently mowed back to 4-6 inches tall when they reach 12 inches in height. In the second year, weeds should continue to be monitored and mowed and rhizomatous weeds should be hand treated with herbicide. Weeds should not be sprayed with herbicide as the drift from the spray may kill large patches of desirable plants, allowing weeds to move in to these new open areas. In the beginning of the third season, the young meadow should be burned off in mid-spring. If burning is not possible, the meadow should be mowed very closely to the ground instead. The mowed material should be removed from the site to expose the soil to the sun. This helps encourage rapid soil warming which favors the establishment of “warm season” plants over “cool season” weeds.

Cost Issues

Landscape restoration cost implications are minimal during construction. Seeding for installation of a conventional lawn is likely to be less expensive than planting of a “cover” of native species, although when contrasted with a non-lawn landscape, “natives” often are not more costly than other nonnative landscape species. In terms of woodland creation, somewhat dated (1997) costs have been provided by the *Chesapeake Bay Riparian Handbook: A Guide for Establishing and Maintaining Riparian Forest Buffers*:

\$860/acre trees with installation
\$1,600/acre tree shelters/tubes and stakes
\$300/acre for four waterings on average

In current dollars, these values would be considerably higher, well over \$3,000/acre for installation costs. Costs for meadow reestablishment are lower than those for woodland, in part due to the

elimination of the need for shelters/tubes. Again, such costs can be expected to be greater than installation of conventional lawn (seeding and mulching), although the installation cost differences diminish when conventional lawn seeding is redefined in terms of conventional planting beds.

Cost differentials grow greater when longer term operating and maintenance costs are taken into consideration. If lawn mowing can be eliminated, or even reduced significantly to a once per year requirement, substantial maintenance cost savings result, often in excess of \$1,500 per acre per year. If chemical application (fertilization, pesticides, etc.) can be eliminated, substantial additional savings result with use of native species. These reductions in annual maintenance costs resulting from a native landscape reestablishment very quickly outweigh any increased installation costs that are required at project initiation. Unfortunately, because developers pay for the installation costs and longer term reduced maintenance costs are enjoyed by future owners, there is reluctance to embrace native landscaping concepts.

Specifications

The following specifications are provided for information purposes only. These specifications include information on acceptable materials for typical applications, but are by no means exclusive or limiting. The designer is responsible for developing detailed specifications for individual design projects in accordance with the project conditions.

Vegetation – See Appendix B

References

- Bowman's Hill Wildflower Preserve, Washington Crossing Historic Park, PO Box 685, New Hope, PA 18938-0685, Tel (215) 862-2924, Fax (215) 862-1846, Native plant reserve, plant sales, native seed, educational programs, www.bhwp.org
- Morris Arboretum of the University of Pennsylvania; 9414 Meadowbrook Avenue, Philadelphia, PA 19118, Tel (215) 247-5777, www.upenn.edu/morris, PA Flora Project Website: Arboretum and gardens (some natives), educational programs, PA Flora Project, www.upenn.edu/paflora
- Pennsylvania Department of Conservation and Natural Resources; Bureau of Forestry; PO Box 8552, Harrisburg, PA 17105-8552, Tel (717)787-3444, Fax (717)783-5109, Invasive plant brochure; list of native plant and seed suppliers in PA; list of rare, endangered, threatened species.
- Pennsylvania Native Plant Society, 1001 East College Avenue, State College, PA 16801
www.pawildflower.org
- Western Pennsylvania Conservancy; 209 Fourth Avenue, Pittsburgh, PA 15222, Tel (412) 288-2777, Fax (412) 281-1792, www.paconserve.org
- Conservation Design for Stormwater Management (DNREC and EMC)
- Stream ReLeaf Plan and Toolkits
- The Once and Future Forest – Leslie Sauer
- Forestry Best Management Practices for Water Quality – Virginia Department of Forestry
- Chesapeake Bay Riparian Handbook: A Guide for Establishing and Maintaining Riparian Forest Buffers (1997)
- Arendt, R. *Growing Greener*. Island Press, November 1999.
- Diboll, Neil. Five Steps to Successful Prairie Meadow Establishment. Windstar Wildlife Institute.
- Penn State College of Agricultural Sciences, Agricultural Research and Cooperation Extension. “ Pennsylvania Wildlife No. 12: Warm-season Grasses and Wildlife” and “Pennsylvania Wildlife No. 5: Meadows and Prairies: Wildlife-friendly Alternatives to Lawn”

BMP 6.7.3: Soil Amendment & Restoration



Soil amendment and restoration is the process of improving disturbed soils and low organic soils by restoring soil porosity and/or adding a soil amendment, such as compost, for the purpose of reestablishing the soil's long-term capacity for infiltration and pollution removal.

<p style="text-align: center;"><u>Key Design Elements</u></p> <ul style="list-style-type: none"> ▪ Existing soil conditions should be evaluated before forming a restoration strategy. ▪ Physical loosening of the soil, often called subsoiling, or tilling, can treat compaction. ▪ The combination of subsoiling and soil amendment is often the more effective strategy. ▪ Compost amendments increase water retention. 	<p style="text-align: center;"><u>Potential Applications</u></p> <p>Residential: Yes Commercial: Yes Ultra Urban: Yes Industrial: Yes Retrofit: Yes Highway/Road: Yes</p>
<p style="text-align: center;"><u>Stormwater Functions</u></p> <p>Volume Reduction: Low/Med. Recharge: Low/Med. Peak Rate Control: Medium Water Quality: Medium</p>	
<p style="text-align: center;"><u>Water Quality Functions</u></p> <p>TSS: 85% TP: 85% NO3: 50%</p>	

Problem Description

Animals, farm equipment, trucks, construction equipment, cars, and people cause compaction. Wet soil compacts easier than dry soil. Natural compaction occurs due to special chemical or physical properties, and these occurrences are called “hard pans”. A typical soil after compaction has strength of about 6,000 kPa, while studies have shown that root growth is not possible beyond 3,000 kPa.



Different Types of Compaction

- 1) Minor Compaction – surface compaction within 8-12” due to contact pressure, axle load > 10 tons can compact through root zone, up to 1’ deep
- 2) Major Compaction – deep compaction, contact pressure and total load, axle load > 20 tons can compact up to 2’ deep (usually large areas compacted to increase strength for paving and foundation with overlap to “lawn” areas)

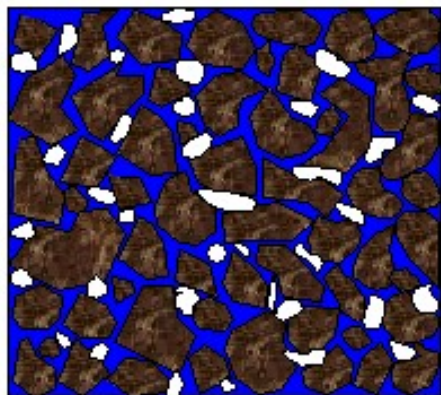

good physical condition

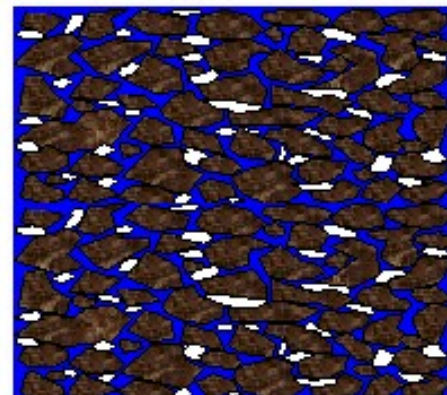
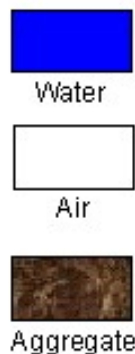

poor physical condition (compacted)

In general, compaction problems occur when airspace drops to 10-15% of total soil volume. Compaction affects the infiltrating and water quality capacity of soils. When soils are compacted, the soil particles are pressed together, reducing the pore space necessary to move air and water throughout the soil. This decrease in porosity causes an increase in bulk density (weight of solids per unit volume of soil). The greater the bulk density, the lower the infiltration and therefore the larger volume of runoff.

Different types of soils have bulk density levels at which compaction starts to limit root growth. When root growth is limited, the uptake of water and nutrients by vegetation is reduced.

Soil organisms are also affected by compaction; biological activity is greatly reduced, decreasing their ability to intake and release nutrients.

The best soil restoration is the complete revegetation of woodlands, as “A mature forest can absorb as much as 14 times more water than an equivalent area of grass.” (DNREC and Brandywine Conservancy, 1997) (See Structural BMP 6.7.2 Landscape Restoration and use in combination with this BMP)

Soil Restoration Methodology

Soil restoration is a technique that can be used to restore and enhance compacted soils or soils low in organic content by physical treatment and/or mixture with additives such as compost. Soil restoration has been shown to alter soil properties known to affect water relations of soils, including water holding capacity, porosity, bulk density and structure. Two methods have been shown to restore some of the characteristics of soils that are damaged by compaction; tilling and addition of amendments such as compost or other materials.

One of the options for soil amendment is compost, which has many benefits. It improves the soil structure, creating and enhancing passageways in the soil for air and water that have been lost due to compaction. This recreates a better environment for plant growth. Compost also supplies a slow release of nutrients to plants, specifically nitrogen, phosphorous, potassium, and sulfur. Using compost reuses natural resources, reducing waste and cost.

Soil amendment with compost has been shown to increase nutrients in the soil, such as phosphorus and nitrogen, which provides plants with needed nutrients, reducing or eliminating the need for fertilization. This increase in nutrients results in an aesthetic benefit as turf grass and other plantings establish and proliferate more quickly, with less maintenance requirements. Soil amendment with compost increases water holding and retention capacity, improves infiltration, reduces surface runoff, increases soil fertility, and enhances vegetative growth. Compost also increases pollutant-binding properties of the soil properties, which improves the quality of the water passing through the soil mantle and into the groundwater.

The second method is tilling, which involves the digging, scraping, mixing, and ripping of soil with the intent of circulating air into the soil mantle in various layers. Compaction down to 20 inches often requires ripping for soil restoration. Tilling exposes compacted soil devoid of oxygen to air and recreates temporary air space.

Soil Texture	Ideal Bulk densities	Bulk densities that may affect root growth	Bulk densities that restrict root growth
	g/cm ³	g/cm ³	g/cm ³
Sands, loamy sands	<1.60	1.69	1.8
Sandy loams, loams	<1.40	1.63	1.8
Sandy clay loams, loams, clay loams	<1.40	1.6	1.75
Silt, silt loams	<1.30	1.6	1.75
Silt loams, silty clay loams	<1.10	1.55	1.65
Sandy clays, silty clays, some clay loams (35-45% clay)	<1.10	1.49	1.58
Clays (>45% clay)	<1.10	1.39	1.47

Source: Protecting Urban Soil Quality, USDA-NRCS

Bulk density field tests may be used to determine the compaction level of soils.

Variations

- Soil amendment media can include compost, sand, and manufactured microbial solutions.
- Seed can be included in the soil amendment to save application time.

Applications

- **New Development (Residential, Commercial, Industrial)** – new lawns can be amended with compost and not heavily compacted before planting, to increase the porosity of the soils.
- **Urban Retrofits** - Tilling of soils that have been compacted before it is converted into meadow, lawn, or a stormwater facility is recommended.
- **Detention Basin Retrofits** – The inside face of detention basins is usually heavily compacted, and tilling the soil mantle on surfaces beyond the constructed embankment will encourage infiltration to take place. Tilling may be necessary to establish better vegetative cover.
- **Landscape Maintenance** – compost can substitute for dwindling supplies of native topsoil in urban areas.
- **Golf Courses** – Using compost as part of the landscaping upkeep on the greens has been shown to alleviate soil compaction, erosion, and turf disease problems.

Design Considerations

1. Treating Compaction by **Soil Restoration**
 - a) Soil amendment media usually consists of compost, but can include mulch, manures, sand, and manufactured microbial solutions.
 - b) Compost should be added at a rate of 2:1 (soil:compost). If a proprietary product is used, the manufacturer's instructions should be followed in terms of mixing and application rate.
 - c) Soil restoration should not be used on slopes greater than 30%. In these areas, deep-rooted vegetation can be used to increase stability.
 - d) Soil restoration should not take place within the drip line of a tree to avoid damaging the root system.
 - e) On-site soils with an organic content of at least 5 percent can be properly stockpiled (to maintain organic content) and reused.
 - f) Procedure: rototill, or rip the subgrade, remove rocks, distribute the compost, spread the nutrients, rototill again.
 - g) Add 6 inches compost / amendment and till up to 8 inches for minor compaction.
 - h) Add 10 inches compost / amendment and till up to 20 inches for major compaction.
2. Treating Compaction by **Ripping / Subsoiling / Tilling / Scarification**
 - a) Subsoiling is only effective when performed on dry soils.
 - b) Ripping, subsoiling, or scarification of the subsoil should be performed where subsoil has become compacted by equipment operation, dried out and crusted, or where necessary to obliterate erosion rills.
 - c) Ripping (Subsoiling) should be performed using a solid-shank ripper and to a depth of 20 inches, (8 inches for minor compaction).

- d) Should be performed before compost is placed and after any excavation is completed.
- e) Subsoiling should not be performed within the drip line of any existing trees, over underground utility installations within 30 inches of the surface, where trenching/drainage lines are installed, where compaction is by design.

Subsoiling should not be performed with common tillage tools such as a disk or chisel plow because they are too shallow and can compact the soil just beneath the tillage depth.

3. Other methodologies:

- a) Irrigation Management – low rates of water should be applied, as over-irrigation wastes water and may lead to environmental pollution from lawn chemicals, nutrients, and sediment.
- b) Limited mowing – higher grass corresponds to greater evapotranspiration.
- c) Compost can be amended with bulking agents, such as aged crumb rubber from used tires or weed chips. This can be a cost-effective alternative that reuses waste materials.
- d) In areas where compaction is less severe (not as a result of heavy construction equipment), planting with deep-rooted perennials can treat compaction, however restoration takes several years.

Table 2. Mean runoff from unvegetated test plots during a 30 minute high-intensity (~ 4 in/hr) rain storm

	Biosolids	Yard Trimmings	Bio-industrial	Compacted Subsoil	Topsoil
Geometric mean runoff (mm) during 30-minute rainfall	0.13 ^a	<0.01 ^a	0.08 ^a	26.22 ^b	15.54 ^b

Values with different letters are significantly different statistically (p<0.05) from one another.

Table 3. Mean time to initiate runoff from unvegetated test plots

	Biosolids	Yard Trimmings	Bio-industrial	Compacted Subsoil	Topsoil
Mean time (min)	31.08 ^c	56.92 ^d	32.17 ^{c,d}	4.67 ^a	7.83 ^b

Values with different letters are significantly different statistically (p<0.05) from one another.

Detailed Stormwater Functions

Infiltration Area (If needed)

The infiltration area will be the entire area restored, depending on the existing soil conditions, and the restoration effectiveness.

Volume Reduction Calculations

Soil Amendments can reduce the need for irrigation by retaining water and slowly releasing moisture, which encourages deeper rooting. Infiltration is increased; therefore the volume of runoff is decreased.

Compost amended soils can significantly reduce the volume of stormwater runoff. For soils that have either been compost amended according to the recommendations of their BMP, or subject to restoration such that the field measured bulk densities meet the Ideal Bulk Densities of Table 1, the following volume reduction may be applied:

$$\text{Amended Area (ft}^2\text{)} \times 0.50\text{in} \times 1/12 = \text{Volume (cf)}$$

Peak Rate Mitigation

See Section 8 for peak rate mitigation.

Water Quality Improvement

See Section 8 for water quality improvement.

**Surface Water Runoff Rate - Austrian Vineyard Data
Municipal Solid Waste Compost Application
30% Slope**

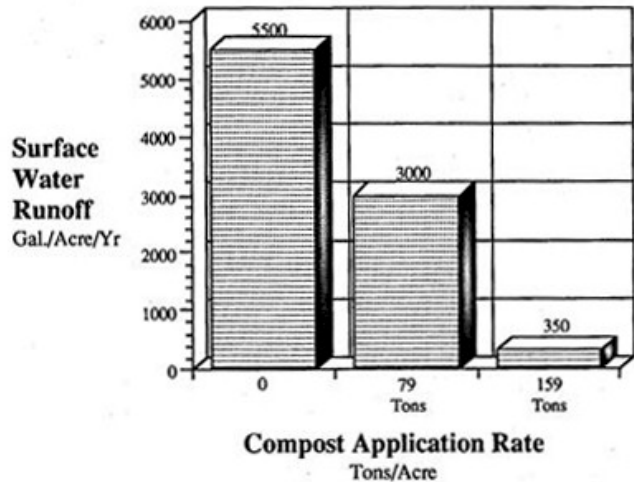

Table 4. Adsorbed Mass of Nutrients and Metals in Unvegetated Plot Runoff From 30-Minute, High-Intensity (100-mm/hr.) Rainstorm

Element	Compost Treatments			Conventional Treatments	
	Biosolids	Yardwaste	Bioindustrial Compost	Compacted Subsoil	Topsoil
	Geometric Mean (mg)				
Chromium	0.01 ^b	<0.01 ^a	<0.01 ^b	0.92 ^c	0.76 ^b
Copper	0.02 ^b	<0.01 ^a	0.01 ^b	1.03 ^c	0.66 ^c
Nickel	<0.01 ^b	<0.01 ^a	<0.01 ^b	0.96 ^c	0.67 ^c
Lead	0.01 ^b	<0.01 ^a	<0.01 ^b	1.82 ^c	0.95 ^c
Zinc	0.10 ^b	<0.01 ^a	0.03 ^b	6.55 ^c	3.99 ^c
Nitrogen	0.47 ^b	<0.01 ^a	0.09 ^{a,b}	266.65 ^c	211.87 ^c
Phosphorus	0.45 ^b	<0.01 ^a	0.09 ^{a,b}	36.47 ^c	29.07 ^c
Potassium	0.17 ^b	<0.01 ^a	0.09 ^{a,b}	103.94 ^c	71.57 ^c

Means within the same row with different letter designations are significantly different (p<0.05).

Highest
Medium
Lowest

Construction Sequence

1. All construction should be completed and stabilized before beginning soil restoration.

Maintenance Issues

The soil restoration process may need to be repeated over time, due to compaction by use and/or settling. (For example, playfields or park areas will be compacted by foot traffic.)

Cost Issues

Tilling costs, including scarifying sub-soils, range from \$800/ac to \$1000/ac.

Compost amending of soil ranges in cost from \$860/ac to \$1000/ac.

Specifications

The following specifications are provided for information purposes only. These specifications include information on acceptable materials for typical applications, but are by no means exclusive or limiting. The designer is responsible for developing detailed specifications for individual design projects in accordance with the project conditions.

1. SCOPE

- a. This specification covers the use of compost for soil amendment and the mechanical restoration of compacted, eroded and non-vegetated soils. Soil amendment and restoration is necessary where existing soil has been deemed unhealthy in order to restore soil structure and function, increase infiltration potential and support healthy vegetative communities.
- b. Soil amendment prevents and controls erosion by enhancing the soil surface to prevent the initial detachment and transport of soil particles.

2. COMPOST MATERIALS

- a. Compost products specified for use in this application are described in Table 1. The product's parameters will vary based on whether vegetation will be established on the treated slope.
- b. Only compost products that meet all applicable state and federal regulations pertaining to its production and distribution may be used in this application. Approved compost products must meet related state and federal chemical contaminant (e.g., heavy metals, pesticides, etc.) and pathogen limit standards pertaining to the feedstocks (source materials) in which it is derived.
- c. Very coarse compost should be avoided for soil amendment as it will make planting and crop establishment more difficult.

- d. **Note 1** - Specifying the use of compost products that are certified by the U.S. Composting Council's Seal of Testing (STA) Program (www.compostingcouncil.org) will allow for the acquisition of products that are analyzed on a routine basis, using the specified test methods. STA participants are also required to provide a standard product label to all customers, allowing easy comparison to other products.

3. SUB-SOILING TO RELIEVE COMPACTION

- a. Before the time the compost is placed and preferably when excavation is completed, the subsoil shall be in a loose, friable condition to a depth of 20 inches below final topsoil grade and there shall be no erosion rills or washouts in the subsoil surface exceeding 3 inches in depth.
- b. To achieve this condition, subsoiling, ripping, or scarification of the subsoil will be required as directed by the owner's representative, wherever the subsoil has been compacted by equipment operation or has become dried out and crusted, and where necessary to obliterate erosion rills. Sub-soiling shall be required to reduce soil compaction in all areas where plant establishment is planned. Sub-soiling shall be performed by the prime or excavating contractor and shall occur before compost placement.
- c. Subsoiled areas shall be loosened to less than 1400 kPa (200 psi) to a depth of 20 inches below final topsoil grade. When directed by the owner's representative, the Contractor shall verify that the sub-soiling work conforms to the specified depth.
- d. Sub-soiling shall form a two-directional grid. Channels shall be created by a commercially available, multi-shanked, parallelogram implement (solid-shank ripper). The equipment shall be capable of exerting a penetration force necessary for the site. No disc cultivators, chisel plows, or spring-loaded equipment will be allowed. The grid channels shall be spaced a minimum of 12 inches to a maximum of 36 inches apart, depending on equipment, site conditions, and the soil management plan. The channel depth shall be a minimum of 20 inches or as specified in the soil management plan. If soils are saturated, the Contractor shall delay operations until the soil will not hold a ball when squeezed. Only one pass shall be performed on erodible slopes greater than 1 vertical to 3 horizontal. When only one pass is used, work should be at right angles to the direction of surface drainage, whenever practical.
- e. Exceptions to sub-soiling include areas within the drip line of any existing trees, over utility installations within 30 inches of the surface, where trenching/drainage lines are installed, where compaction is by design (abutments, footings, or in slopes), and on inaccessible slopes, as approved by the owner's representative. In cases where exceptions occur, the Contractor shall observe a minimum setback of 20 feet or as directed by the owner's representative. Archeological clearances may be required in some instances.

4. COMPOST SOIL AMENDMENT QUALITY

- a. The final, resulting compost soil amendment must meet all of the mandatory criteria in Table 4.

5. COMPOST SOIL AMENDMENT INSTALLATION

- a. Spread 2-3 inches of approved compost on existing soil. Till added soil into existing soil with a rotary tiller that is set to a depth of 6 inches. Add an additional 4 inches of approved compost to bring the area up to grade.
- b. After permanent planting/seeding, 2-3 inches of compost blanket will be applied to all areas not protected by grass or other plants

References

“The Compaction of Urban Soils”, Technical Note #107 from Watershed Protection Techniques, Article 36, 3(2): 661-665.

Dallas, H. and A. Lewandowski, 2003. Protecting Urban Soil Quality: Examples for Landscape Codes and Specifications. USDA Natural Resources Conservation Services.

OCSCD, 2001. *Impact of Soil Disturbance During Construction on Bulk Density and Infiltration in Ocean County, New Jersey*. Ocean County Soil Conservation District, Schnabel Engineering Associates, Inc., USDA Natural Resources Conservation Services. www.ocscd.org.

Pitt, R. et al., 2002. “Compacted Urban Soils Effects on Infiltration and Bioretention Stormwater Control Designs.”

Pitt, R. et al., 2002. “Infiltration Through Disturbed Urban Soils and compost-Amended Soil Effects on Runoff Quality and Quantity.”

“The Relationship Between Soil and Water”, Soils for Salmon, The Urban Environment, 1999

“Soil Quality Resource Concerns: Compaction”, USDA Natural Resources Conservation Service, 1996

“Soil Quality Resource Concerns: Available Water Capacity”, USDA Natural Resources Conservation Service, 1998

“Specifications for Soil Amendments”, Low Impact Development Center, Inc., www.lid-stormwater.net/soilamend/soilamend_specs.htm

“Urban Soil Compaction”, Soil Quality – Urban Technical Note, No. 2, USDA Natural Resources Conservation Services, 2000.

Department of Natural Resources and Environmental Control Division of Soil and Water. *Delaware Erosion and Sediment Control Handbook for Development*. Newark, DE

BMP 6.7.4: Floodplain Restoration

Floodplain restoration tries to mimic the interaction of groundwater, stream base flow, and root systems – key components of a stream corridor under pre-settlement (pre-1600s) conditions. Under pre-settlement conditions, typically the roots of the riparian vegetation on the floodplain were directly linked to the base flow elevation of the stream. Groundwater frequently interacted with the root zones and the stream’s base flow. Where the groundwater was lower than the stream’s base flow, the gravel-lined streams and permeable floodplains frequently reduced surface flows through infiltration. The interaction among the stream’s base flow, groundwater, permeable floodplain soils, and riparian root zones provides multiple benefits, including the filtering of sediments and nutrients through retention of frequent high flows onto the floodplain, removal of nitrates from groundwater, reduction of peak flow rates, groundwater recharge/infiltration, and increase of storage and reduction of flood elevations during higher flows. As a result of historical and recent human impacts, many stream networks have little interaction among the groundwater, stream base flow, and the root systems of floodplain vegetation. Frequently, recently deposited floodplain soils are cohesive, separating the root zones from base flow and allowing only minimal infiltration from the surface flow through the porous pre-settlement soils and gravels. Floodplain restoration as a BMP should be considered where there is minimal interaction among the key components. Other benefits of this BMP include thermal cooling of the stream base-flow, improved benthic community species diversity and habitat, re-establishment and significant increases of wetland areas and native plant species on the floodplain, reduction of invasive plant species, and increased aquatic habitat and riparian areas.

<p style="text-align: center;"><u>Key Design Elements</u></p> <ul style="list-style-type: none"> ▪ A natural, system-based BMP that uses native vegetation, soils, and other natural elements ▪ Can be easily integrated into the initial site planning process Can prevent riparian problems from getting worse or can fix problems caused by historical practices ▪ Can address numerous problems, from the site level to the watershed level ▪ Provides multiple benefits of restoring a fluvial and riparian system to a fully functioning level of interaction ▪ Re-connection of stream channel to functional floodplain ▪ Incorporation of an aquatic and riparian system that interacts with the groundwater and/or stream base flow. ▪ Reattachment of root systems of floodplain vegetation/riparian areas connected to groundwater and/or base flow. ▪ Removal of “legacy sediments” and associated nutrients stored within the stream corridors prior to release through bank erosion. 	<p style="text-align: center;"><u>Potential Applications</u></p> <p>Residential: Yes Commercial: Yes Ultra Urban: Yes Industrial: Yes Retrofit: N/A Highway/Road: Yes</p>
	<p style="text-align: center;"><u>Stormwater Functions</u></p> <p>Volume Reduction: Low/High Recharge: Low/High Peak Rate Control: Medium Water Quality: Med/High</p>
	<p style="text-align: center;"><u>Water Quality Functions</u></p> <p>TSS: 85% TP: 85% NO3: >30%</p>

Description

Floodplain restoration as a BMP is an effective tool to meet water quality and quantity requirements, prevent riparian problems from getting worse, and fix current problems caused by historical practices. The interaction and connection of the groundwater, stream base flow, riparian vegetation root system, and permeable floodplain soils and gravels immediately reduce downstream sedimentation by stopping or greatly reducing stream bank and channel erosion. The “legacy sediments” stored in stream valleys create unnaturally high stream banks and floodplains that frequently contain massive amounts of nutrients, which are released during erosion. Additionally, high banks separate plant root zones from the nitrates in the stream base flow and groundwater. Thus, instead of nitrogen being removed by the plants, groundwater and base flow continue to transport nitrates to receiving waters. Floodplain restoration directly removes a significant source of phosphorus and sediments and creates a riparian/aquatic environment to provide effective denitrification. Additionally, a restored floodplain and stream may greatly enhance infiltration and storage of surface flow in the floodplain, which reduces flood flow stages, volumes, and peak discharges. Floodplain restoration is an effective technique to meet stormwater management initiatives. One of the great advantages of this technique is that it can address numerous problems, from the site-specific to the watershed-level. Floodplain restoration can prevent or substantially mitigate the full range of stormwater impacts in one BMP. It is a natural, system-based BMP that uses native vegetation, soil, and other natural features. Floodplain restoration reconnects a number of key components within a stream corridor so that their interaction protects the stability of the bed and channel while the system receives, holds, infiltrates, and filters sediment and nutrients from overland flow. These components include:

- a floodplain that receives more routine flows, thereby reducing erosive flow forces in the channel and allowing existing sediments and nutrients to remain in storage;
- a floodplain that allows vegetative root systems to interact with the base flow and/or groundwater, providing frequent removal of nitrates and effective stabilization of the stream banks and floodplain;
- a floodplain wide and flat along the valley bottom, consisting of the proper earthen materials to absorb surface flows and increase infiltration to groundwater;
- a plant community adapted to frequent inundation that will provide suitable habitat for riparian wildlife and whose root systems will provide nitrate and phosphate removal from surface and/or groundwater; and
- increased and improved habitat for aquatic resources.

Traditional on-site BMPs focus on the development site itself, while floodplain restoration can focus not only on the development site but also on the receiving streams. Adding floodplain restoration to the toolbox also increases the flexibility to address onsite BMP limitations such as steep slopes, shallow bedrock, or property limitations.

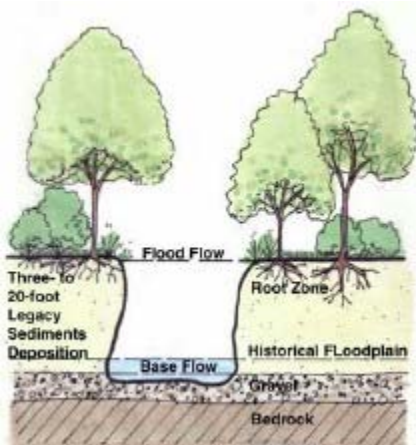

Existing Conditions: Stream channels are eroding or have eroded back down through sediments that collected behind mill dams, leaving their alluvial terraces high above the current base flow water elevation, and disconnecting riparian root systems from groundwater flows. The processes of frequent floodplain inundation, which relieves in-channel stresses; groundwater infiltration through porous floodplain material, and nitrogen removal from groundwater through root systems are lost under these conditions that are prevalent today throughout the Piedmont region of the United States.

Pre-settlement / Restored Conditions:

Stable, pre-settlement stream and floodplain systems were characterized by: a low floodplain in close contact with surface water in the stream channel, allowing for frequent inundation of the floodplain during high flows; riparian vegetation with roots zones in contact with groundwater that enabled ground-water denitrification through root uptake; and a channel bed composed of cobble and gravel, which helped protect the underlying bedrock from erosive flow forces.

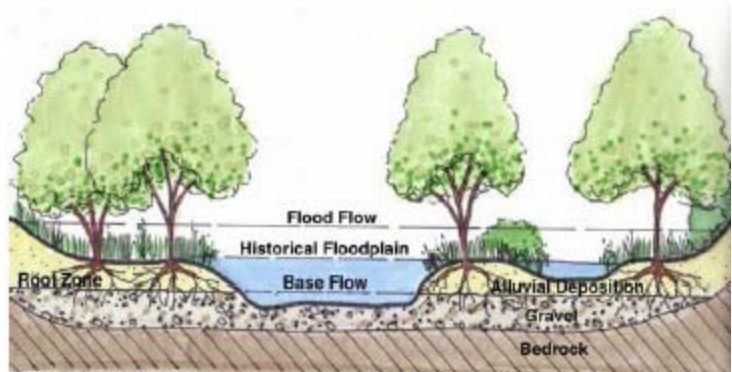

Santo Domingo Creek, Lititz Run Watershed, Lancaster County, Pa.

Top Left: Existing conditions.

Top Right: Restored conditions

Right: Riparian Wetland adjacent to channel.



Variations

When implementing a Floodplain Restoration BMP, existing site constraints can influence the opportunity or potential to achieve all the benefits. Impacts to natural channels often create streambeds that are perched above the historical bed that existed prior to the 1600s. This is especially the case when historical milldams, creating significant backwater influences upstream of the physical dam, caused natural channels to fill with fine alluvial sediments from hillside erosion during the widespread land-clearing of the post-settlement era. When current streambeds are perched, it is often the case that the groundwater elevation is below the streambed. In this case, base flow, whether intermittent or perennial, flows on the perched streambed and has little interaction with the groundwater elevation below the streambed. The fine alluvial sediments that washed from the hillsides often act as a barrier, keeping the in-channel base flow and groundwater separated.

As a **first priority**, the design of a Floodplain Restoration BMP should attempt to establish the proposed streambed so that the base flow in the channel is connected to the pre-settlement streambed gravels and, typically, the groundwater elevation. This scenario provides the greatest benefit for nutrient uptake, because the newly established, active, vegetated root zone will be highly attached to the groundwater and base flows in the new active channel. Where cohesive soils or clays separate the top of the floodplain from the underlying porous material, these cohesive materials should be replaced with more porous soils. On sites where vertical constraints from existing infrastructure, such as roadway crossings, culverts, and utility crossings, prevent lowering the restored streambed to its historical pre-settlement elevation that would, in many cases, have been attached to the groundwater elevation, then a **second priority** to the Floodplain Restoration BMP should be utilized. The second priority shall be utilized where site constraints do not allow for the reconnection of the restored streambed to the groundwater elevation. In this case, the restored channel should be established such that the base flow or, in the case of an intermittent stream, the streambed is highly attached to the stream bank vegetated root zone, meaning that the established root zone extends down to the streambed elevation.

Applications

On-Site: When a stream is located within or immediately adjacent to a proposed development site, the Floodplain Restoration BMP can be directly tied into the site development stormwater management plan, given the stream is in need of restoration as a stand-alone BMP or as a supplemental BMP to other stormwater BMP needs. **Off-Site:** On development projects that do not have a stream on or adjacent to the site, the Floodplain Restoration BMP may be implemented on the downstream receiving stream or within the watershed. Existing watershed prioritization studies may be useful in identifying appropriate sites for off-site applications of this BMP. In areas where existing wetlands or mature riparian forests or vegetation exist, this practice may not be applicable. The benefits of the practice must be weighed against the impact to determine if this method is acceptable.

Design Considerations

The goal of floodplain restoration is to re-establish the natural interaction of a stream system, including surface flow; groundwater; porous, organic floodplain soils; and vegetative roots systems by re-establishing the stream channel and adjacent floodplain in their natural valley-flat location such that it functions similarly to the pre-settlement conditions. Any restoration required for the stream channel itself should follow the guidelines established by the Keystone Stream Team in *Guidelines For Natural Stream Channel Design for Pennsylvania Waterways*.

General design procedures:

1. Determine if the vegetative root zone is connected to the base flow and groundwater or, in the case of an ephemeral stream, the stream bed. A simplified way to determine root zone connection is to examine the root depth of the vegetation on the floodplain or out-of-bank level along the active stream banks. If the base of the active root zone extends into the base flow or channel bed region, then the floodplain is likely to be attached to the active stream channel.
2. Excavate a trench(es) or perform geo probes along the existing floodplain to determine pre-settlement floodplain and streambed elevations. Typically, the buried pre-settlement floodplain consists of dark peat and organic material.

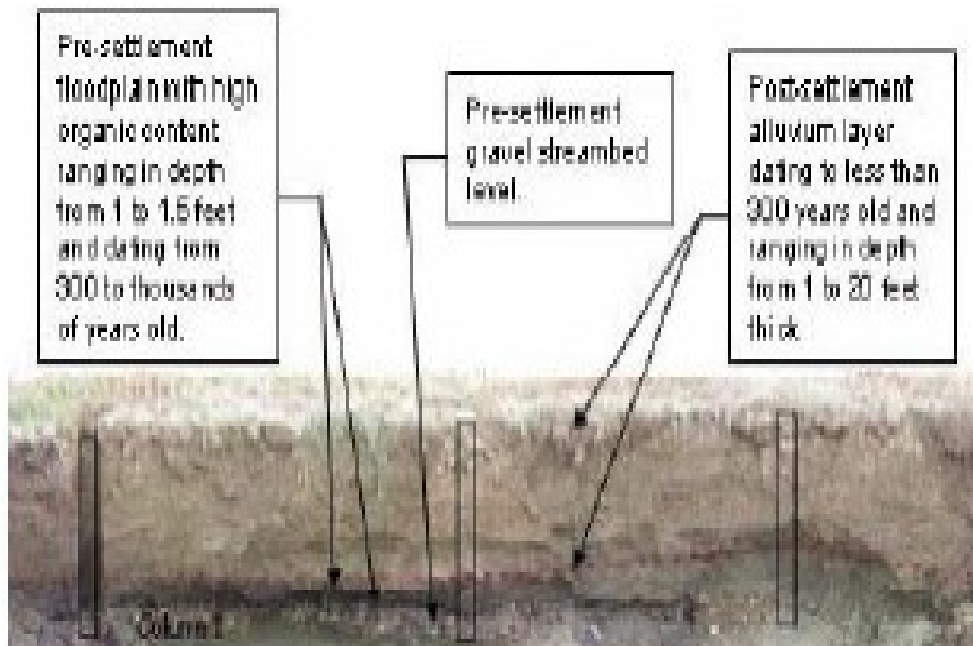

Trench excavated across the existing floodplain reveals the pre-settlement streambed and floodplain levels currently buried under post-settlement alluvium and facilitates soil layer analyses, including various dating procedures.

3. Identify any vertical constraints or limitations that may prevent the floodplain restoration from providing the interconnection of the key components described above.
4. If the channel bed exists at the groundwater or pre-settlement bed elevation, then lower the floodplain and re-establish the appropriate vegetation where the rooting depth is connected to the base flow and/or groundwater.
5. If downstream constraints such as utility crossings or culverts will not allow lowering the floodplain and stream bed to its pre-settlement elevation, and floodplain soils are porous, excavate the existing

floodplain soils to an elevation that allows the floodplain vegetative root systems to be connected to the base flow elevation.

6. If downstream constraints such as utility crossings or culverts will not allow lowering the floodplain and stream bed to its pre-settlement elevation, and floodplain soils are cohesive and non-porous, remove the clays and replace with more porous materials to an elevation that allows the floodplain vegetative root systems to be connected to the base flow elevation.
7. Hydrologic/hydraulic studies may be necessary as required.
8. Obtain federal, state, and local permits and coordinate with local floodplain regulations.
9. Accommodate multiple uses, such as greenways, trails, and other stormwater BMPs as pre-treatment or energy dissipation measures.
10. Based on preceding design procedures, excavate floodplain to proper elevation and provide vegetative stabilization of the restored floodplain area. Vegetation establishment is an integral part of a floodplain restoration. Vegetation will help reduce flow velocities, promote settling, provide nutrient uptake, provide filtering, limit erosion along streambanks, and prevent active channel short-circuiting in the floodplain. Robust, non-invasive, perennial plants that establish quickly are ideal for floodplain restoration. The designer should select native species that are tolerant of a range of conditions, such as those accustomed to saturated conditions, emergent and upland areas.

Detailed Stormwater Functions

Volume Reduction Calculations: Floodplain restoration can achieve increased flood storage. Floodplain wetlands can attenuate smaller flows until the capacity of these wetlands is exceeded. The volume of soils removed as part of the floodplain restoration is now available for storage of flood flows and is capable of conveying flood flows at lower elevations, thus reducing water surface elevations and nuisance flooding.

Peak Rate Mitigation Calculations: Peak rate is primarily controlled through the infiltration of runoff and additional storage from runoff and receiving waters in the floodplain. Also, the shallow depth and high floodplain roughness can increase the travel time, reducing downstream peak rates.

Water Quality Improvements: Floodplain restoration will reduce the sediment load through the reduction of streambank erosion and the reconnection of the stream channel to a functional floodplain. A floodplain also promotes deposition of fine sediments and filtering of nutrients. Root zones attached to the base flow and groundwater remove nutrients during low flow or drought periods. The floodplain also acts as a riparian buffer or a vegetated filter strip filtering nutrients and sediment from overland runoff prior to waters entering the stream channel.

Recharge: The wide and flat area of the floodplain along the valley bottom should typically be porous, providing a large area for infiltration. In many “karst” or limestone areas, the channel bed may be significantly higher than the groundwater elevation. The channel and floodplain in these areas can provide significant groundwater recharge even during drought conditions. The floodplain/channel bed must consist of the proper earthen materials to absorb surface flows, increase infiltration to groundwater, and promote groundwater recharge.

Construction Sequence

The Pennsylvania Keystone Stream Team has developed *Guidelines For Natural Stream Channel Design for Pennsylvania Waterways*, and Construction Considerations are discussed specifically in Chapter 8.

Maintenance Issues

Floodplain restoration projects must have a maintenance plan that will address the condition of the channel and floodplain through the monitoring of the survivability of the riparian plan implemented with the restoration project. As discussed in the design considerations, vegetation establishment is paramount to the stability of streambanks and the floodplain. Vegetation established along the streambanks and within the floodplain should maintain a minimal 85 percent survival rate, which should be documented through the implementation of a monitoring plan.

Monitoring of the floodplain restoration should coincide with the regulatory requirements established by state and federal regulatory agencies. These monitoring requirements are typically established as a condition of the issuance of a permit to authorize the floodplain restoration activities.

Weed and Invasive Plant Control

Weeds and invasive plants limit buffer growth and survival of native plants; therefore, weeds and invasive plants should be controlled by either herbicides, mowing, or weed mats. These techniques may need to be implemented after the first growing season and may need to continue into the fourth year after the implementation of the floodplain restoration.

Herbicides

This is a short-term (two to three years) maintenance technique that is generally less expensive and more flexible than mowing and will result in a quicker establishment of the buffer. Herbicide use is regulated by the Pennsylvania Department of Agriculture. Proper care should be taken to ensure that proximity to water features is considered.

Mowing

Mowing controls the height of the existing grasses yet increases nutrient uptake; therefore, competition for nutrients will persist until the canopy closure shades out lower layers. Mowing could occur twice each growing season. Mower height should be set between eight and 12 inches.

Weed Mats

Weed mats are geo-textile fabrics that are used to suppress weed growth around newly planted vegetation by providing shade and preventing seed deposition. Weed mats are installed after planting, and should be removed once the trees have developed a canopy that will naturally shade out weeds. Once established, the floodplain restoration project should require little to no long-term maintenance.

Cost Issues

The Pennsylvania Keystone Stream Team has developed preliminary cost ranges associated with the assessment, design, permitting, and implementation of floodplain restoration projects. They can be found at the Keystone Stream Team website: <http://www.keystonestreamteam.org/>.

Specifications

Floodplain restoration designs need to accommodate the sediment loads of the watershed without aggrading or degrading. Guidelines for floodplain restoration projects can be found in the Keystone Stream Team's *Guidelines for Natural Stream Channel Design for Pennsylvania's Waterways* (March 2003).

References

Guidelines For Natural Stream Channel Design for Pennsylvania Waterways, Chapter 8, Keystone Stream Team, March 2003.

Cost Ranges Outline, Keystone Stream Team website: www.keystonestreamteam.org
Northern Lancaster County Groundwater Study: A Resource Evaluation of the Manheim-Lititz and Ephrata Area Groundwater Basins, Edwards, Robert E. and Pody, Robert D., Susquehanna River Basin Commission, Publication No. 235, September 2005.

Santo Domingo Creek Sediment & Nutrient Load Study, Lititz Borough, Lancaster County, PA, www.landstudies.com, LandStudies, Inc., October 2004.

“Back to the Future”: Stream Corridor Restoration and Some New Uses for Old Floodplains, www.landstudies.com, LandStudies, Inc. March 2004.

Sediment and Soil Site Investigation, Merritts, Dorothy, Ph.D., Walter, Robert, Ph.D., DeWet, Andrew, Ph.D., Franklin & Marshall College, January 2005.

6.8 Other BMPs and Related Measures

BMP 6.8.1: Level Spreader

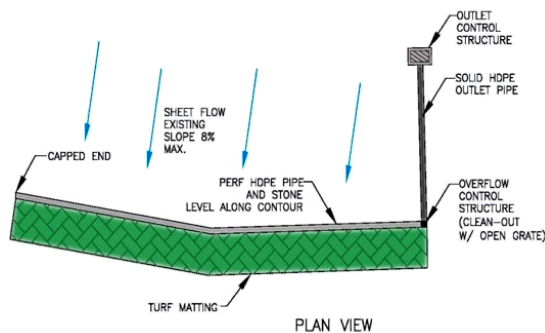

Level Spreaders are measures that reduce the erosive energy of concentrated flows by distributing runoff as sheet flow to stabilized vegetative surfaces. Level Spreaders, of which there are many types, may also promote infiltration and improved water quality.

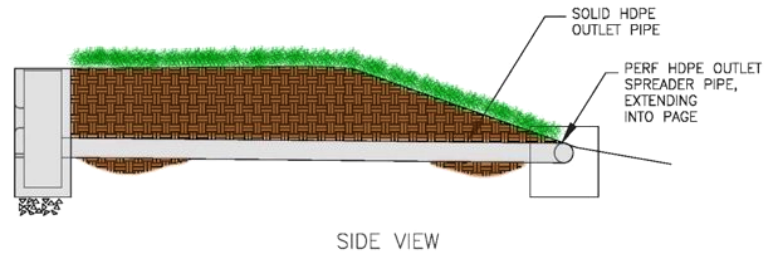

<p style="text-align: center;"><u>Key Design Elements</u></p> <ul style="list-style-type: none"> ▪ Level spreaders must be level. ▪ Specific site conditions, such as topography, vegetative cover, soil, and geologic conditions must be considered prior to design; level spreaders are not applicable in areas with easily erodible soils and/or little vegetation. ▪ Level spreaders should safely diffuse at least the 10-year storm peak rate; bypassed flows should be stabilized in a sufficient manner. ▪ Length of level spreaders is dependent on influent flow rate, pipe diameter (if applicable); number and size of perforations (if applicable), and downhill cover type. ▪ It is always easier to keep flow distributed than to redistribute it after it is concentrated; multiple outfalls/level spreaders are preferable to a single outfall/level spreader. 	<p style="text-align: center;"><u>Potential Applications</u></p> <p>Residential: Yes Commercial: Yes Ultra Urban: Limited Industrial: Yes Retrofit: Yes Highway/Road: Yes</p>
	<p style="text-align: center;"><u>Stormwater Functions</u></p> <p>Volume Reduction: Low Recharge: Low Peak Rate Control: Low Water Quality: Low</p>
	<p style="text-align: center;"><u>Water Quality Functions</u></p> <p>TSS: 20% TP: 10% NO3: 5%</p>

Description

Ensuring distributed, non-erosive flow conditions is an important consideration in any stormwater management strategy and particularly critical to the performance of certain BMPs (e.g. filter strips). Level spreading devices diffuse flows (both low and high), promote infiltration, and improve water quality by evenly distributing flows over a stabilized vegetated surface. There are many different types and functions of level spreaders. Examples include concrete sills (or lips), curbs, earthen berms, and level perforated pipes.

For the purposes of the Manual, there are essentially two categories of level spreaders. The first type of level spreader (Inflow) is meant to evenly distribute flow entering into another structural BMP, such as a filter strip, infiltration basin, or vegetated swale. Examples of this type of level spreader include concrete sills (or lips), curbs, and earthen berms. The second type of level spreader (Outflow) is intended to reduce the erosive force of low to moderate flows while at the same time enhancing natural infiltration opportunities. Examples of this second type include a level, perforated pipe in a shallow aggregate trench (similar to an Infiltration Trench) and earthen berms. While the first type of level spreader can be a very effective measure, it is already discussed in some detail as a design consideration in other structural BMPs and particularly in BMP 6.4.10 Infiltration Berms. This section therefore, focuses primarily on the second category of level spreaders.

Outflow level spreaders are often used in conjunction with other structural BMPs, such as BMP 6.4.2 Infiltration Basins and BMP 6.4.3 Subsurface Infiltration Bed. However, in certain situations, they can be used as “stand alone” BMPs to dissipate runoff from roofs or other impervious areas. In either case, level spreaders might account for some level of volume and rate reduction, the degree to which depends on the specific design, natural infiltration rate of the soil, amount of influent runoff, vegetation density and slope of downhill area, and extent (length of level spreader). Specific credit, as defined in BMPs 5.8.1 and 5.8.2, is given to stand alone level spreaders for impervious areas greater than 500 square feet.

A typical level spreader that is used in conjunction with another structural BMP is a level perforated pipe in a shallow aggregate trench. Though the actual design will vary, a “level spreader pipe” should be designed to at least distribute to the 10-year storm. Depending on the computed flow rate and available space, the designer may provide enough length of pipe to distribute the 100-year storm (see Design Considerations). If space is limited, then flows above the 10-year storm may be allowed to bypass the level spreader. The level spreader pipe must be installed evenly along a contour at a shallow depth in order to ensure adequate flow distribution and discourage channelization. In some cases, a level spreader pipe may be “upgraded” to an Infiltration Trench if additional volume and rate reduction is required (see BMP 6.4.4, Infiltration Trench).

The condition of the area downhill of a level spreader should be considered prior to installation. For instance, the slope, density and condition of vegetation, natural topography, and length (in the direction of flow) will all affect the effectiveness of a distributed flow measure. Areas immediately downhill from a level spreader may need to be stabilized, especially if they have been recently disturbed. Erosion control matting and/or compost blanketing are the recommended measures for achieving permanent downhill stabilization. Permanent vegetative stabilization should be in place prior to placing the level spreader into operation. Manufacturer’s specifications should be followed for chosen stabilization measure.

Variations

- Inflow Level Spreaders**

Evenly distribute flow entering into another structural BMP, such as a filter strip or infiltration basin. Examples include concrete sills (or lips), curbs, concrete troughs, ½ pipes, short standing PVC-silt fence, aggregate trenches, and earthen berms (see Infiltration Berms and Filter Strips). To ensure even distribution of flow, it is critical that these devices be installed as levelly as possible. More rigid structures (concrete, wood, etc.) are often preferable to earthen berms, which have the potential to erode.

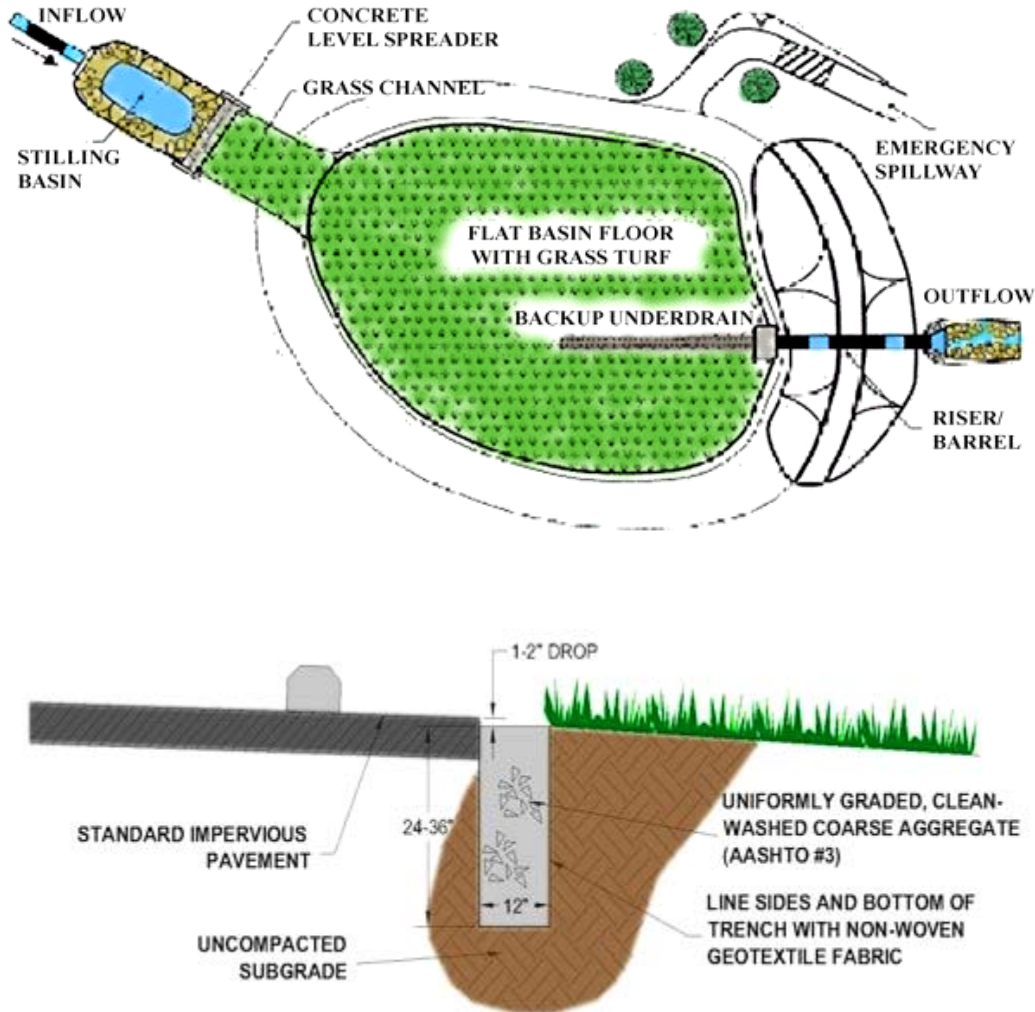

- Outflow Level Spreaders (in conjunction with structural BMP)**
 Reduces the erosive force of low to moderate flows while at the same time enhancing natural infiltration opportunities. Examples include a level perforated pipe in a shallow aggregate trench (similar to an Infiltration Trench) and earthen berms.

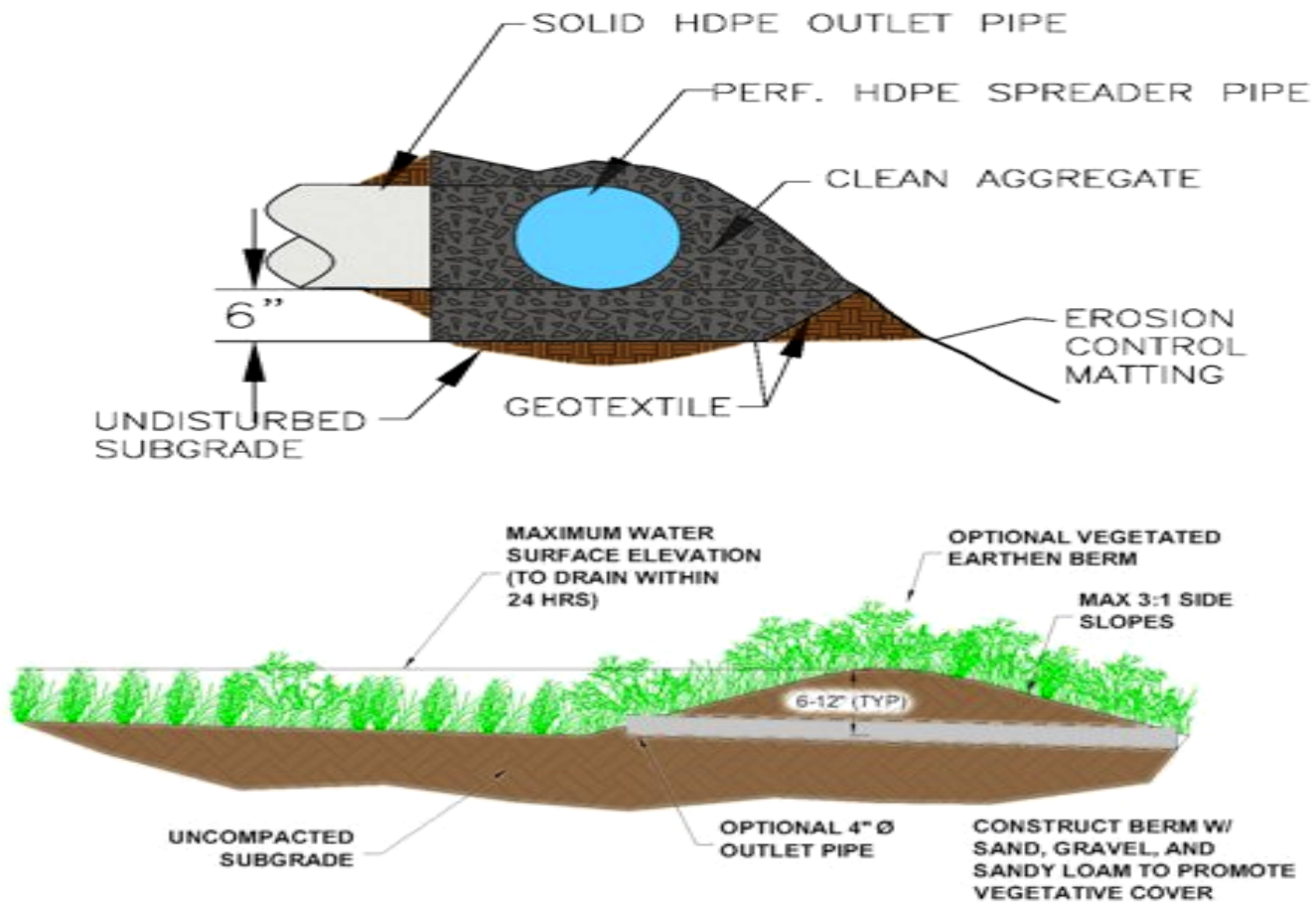

- Outflow Level Spreader (stand alone)**
 Distribute runoff from roofs or other impervious areas of 500 square feet or less. Unless modified to approximate an Infiltration Trench, stand-alone level spreaders do not usually account for substantial volume or rate reductions. However, if designed and installed properly, they still represent effective flow diffusion devices with some water quality benefits.



Applications

- **Ultimate outlet from structural BMPs not discharging directly to a receiving stream**
- **Roof downspout connections (roof area < 500sf)**
- **Inlet connections (impervious area < 500sf)**
- **Inflow to structural BMP, such as filter strip, infiltration basin**

Design Considerations

1. It is usually preferable to not initially concentrate stormwater and provide as many outfalls as possible. This can reduce or even eliminate the need for devices to provide even distribution of flow.
2. Receiving soils and land cover should be undisturbed or stabilized with vegetation or other permanent erosion-resistant material prior to receiving runoff. Level spreaders are not applicable in areas with easily erodable soils and/or little vegetation. The slope below the level spreader should be relatively smooth in the direction of flow to discourage channelization. The minimum flow length of the receiving area should be 75 feet.
3. For design considerations of earthen berm level spreaders refer to BMP 6.4.10 Infiltration Berm.
4. Level spreaders should not be located in constructed fill. Virgin soil is much more resistant to erosion than fill.
5. Level spreaders should not be used for sediment removal. Significant sediment deposition in a level spreader will render it ineffective.
6. A perforated pipe level spreader may range in size from 4 to 12 inches in diameter. The pipe should be laid in an envelope of AASHTO #57 stone, the thickness of which is based upon the desired volume reduction. A deeper trench will provide additional volume reduction and should be included in the calculations (see BMP 6.4.4 Infiltration Trench). Non-woven geotextile should be placed below the aggregate to discourage clogging by sediment.

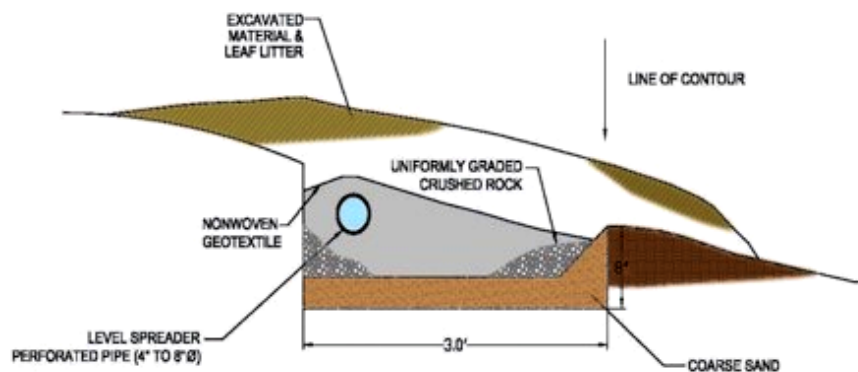

7. The length of level spreaders is primarily a function of the calculated influent flow rate. The level spreader should be long enough to freely discharge the calculated peak flow rate. At a minimum, the peak flow rate shall be that resulting from a 10-year/24-hour design storm. This flow rate should be safely diffused without the threat of failure (i.e. creation of erosion gullies or rills). Diffusion of the storms greater than the 10-year/24-hour storm is permissible if space permits. Generally, level spreaders should have a minimum length of ten feet and a maximum length of 200 feet.

Conventional level spreaders designed to diffuse all flow rates should be sized based on the following:

For grass or thick ground cover vegetation:

- a) 13 linear feet of level spreader for every 1 cfs flow
- b) Slopes of 8% or less from level spreader to toe of slope

For forested areas with little or no ground cover vegetation:

- a) 100 linear feet of level spreader for every 1 cfs flow
- b) Slopes of 6% or less from level spreader to toe of slope

Determining the perforation discharge per linear foot of pipe may further refine the length of a perforated pipe level spreader. A level spreader pipe shall safely discharge in a distributed manner at the same rate of inflow. Perforated pipe manufacturers' specifications provide the discharge per linear foot of pipe, though it is typically based on the general equation for flow through an orifice. Manufacturer's specifications can be used to find the right combination of length and size of pipe. If the number of perforations per linear foot (based on pipe diameter) and average head above the perforations are known, then the flow can be determined by the following equation:

$$L \text{ (length of level spreader pipe)} = Q / Q_L$$

Q_L (discharge per linear foot) = Q_O * # of perforations per linear foot of pipe (provided by manufacturer, based on perforation diameter)

$$Q_O \text{ (perforation flow rate)} = C_d * A * (2 * g * H)^{0.5}$$

Q_O = the free outfall flow rate through one perforation (ft³/sec)

C_d = Coefficient of discharge (typically 0.60)

A = Cross sectional area of one perforation (ft²)

g = 32.2 ft/sec²

H = head, average height of water above perforation (ft) (provided by manufacturer)

For example, the 10- and 100-year design flows for a site were determined to be 2 and 5 cfs, respectively. Assuming a 12-in diameter pipe with thirty-six 0.375-in. diameter perforations per linear foot and an H value of 0.418 feet, the discharge per linear foot is calculated at 0.086 cfs/ft. When the two design flows are divided by the discharge per linear foot, the resulting required lengths are 24 and 59 feet, respectively.

This calculation assumes a free flow condition. Since the level spreader pipe is encased in aggregate (which is around 40% void space) this assumption is usually acceptable. However, for this reason and to account for the potential for clogging of perforations over time, the length of pipe should be multiplied by minimum factor of safety of 1.1.

8. Flows (> 10-year storm peak rate) may bypass a level spreader in a variety of ways, including an overflow structure or up-turned ends of pipe. (The ends of the perforated pipe could be turned uphill at a 45-degree angle or more with the ends screened.) Cleanouts/overflow structures with open grates can also be installed along longer lengths of perforated pipe. The designer shall provide stabilization measures for bypassed flows in a manner consistent with the Pennsylvania Erosion and Sedimentation Pollution Control Program Manual.
9. Erosion control matting or compost blanketing is recommended immediately downhill and along the entire length of the level spreader, particularly in those areas that are unstable or have been recently disturbed by construction activities. Generally, low flows that are diffused by a level spreader do not require additional stabilization on an already stabilized and vegetated slope. The installation requirements for erosion control methods will vary according to the manufacturer's specifications.

There are a variety of permanent erosion control alternatives to riprap currently on the market. Turf/reinforcement matting is a manufactured product that combines vegetative growth and synthetic materials to reduce the potential for soil erosion on slopes. It is typically made of synthetic materials that will not biodegrade and will create a foundation for plant roots to take hold, extending the viability of grass beyond its natural limits.

Compost blankets are an emerging technology that serves a similar function to permanent erosion control matting. When compost is applied as a "blanket" over a disturbed area, it encourages a thicker, more permanent vegetative cover due to its ability to improve the infrastructure of the soil. Compost blankets reduce runoff volume by holding water in its pores and improve water quality by binding and degrading specific chemical contaminants.



Detailed Stormwater Functions

Volume Reduction Calculations

In general, level spreaders do not substantially reduce runoff volume. However, for level spreaders designed similar to Infiltration Trenches, a volume reduction can be achieved. Also, for level spreaders serving as stand-alone BMPs (for contributing impervious up to 500 square feet), volume reduction credits, as discussed in BMPs 5.8.1 and 5.8.2, can be achieved for runoff disconnection. The true amount of volume reduction will depend on the length of level spreader, the density of vegetation, the downhill length and slope, the soil type of the receiving area, and the design runoff. Large areas with heavy, dense vegetation will absorb some flows, while barren or compacted areas will absorb limited amounts of runoff. See Section 9 for detailed calculation methodologies.

Peak Rate Mitigation Calculations

The influent peak rate to a level spreader will be diffused (or dissipated) over the length of the level spreader; the number of perforations in a level spreader pipe will essentially divide the concentrated flow into many smaller flows. To be conservative, and to allow for the possibility of re-convergence, the peak rate should be taken prior to diffusion from the level spreader. See Section 9 for detailed calculation methodologies.

Water Quality Improvement

Water quality improvements occur if the area down gradient of the level spreader is vegetated, stabilized, and minimally sloped. See Section 9 for Water Quality Improvement methodology, which addresses pollutant removal effectiveness of this BMP.

Construction Sequence

1. Level spreaders are considered a permanent part of a site's stormwater management system. Therefore, the uphill development should be stabilized before diverting runoff to any dispersing flow techniques. If the level spreader is used as an erosion and sedimentation control measure, it must be reconfigured (flush perforated pipe, clean out all sediment), to its original state before use as a permanent stormwater feature.
2. All contributing stormwater elements (infiltration beds, inlets, outlet control structures, pipes, etc) should be installed.
3. Perforated pipe should be installed along a contour, with care taken to construct a level bottom. The pipe can be underground in a shallow infiltration trench (see Infiltration Trench for design guidance), or closer to the surface and covered with a 12-inch thick layer of AASHTO #57 stone. If the perforated pipe is in a trench, excavate to the design dimensions. If the pipe is to be at or near the surface, some minor excavation or filling may be necessary to maintain a level bottom.
4. If necessary, install erosion control matting along the length of the level spreader and to a distance downhill, as specified by the manufacturer/supplier. Cover the pipe with AASHTO #57 stone.
5. For construction sequence of earthen berms, see BMP 6.4.10 Infiltration Berm.

Maintenance Issues

Compared with other BMPs, level spreaders require only minimal maintenance efforts, many of which may overlap with standard landscaping demands. The following recommendations represent the minimum maintenance effort for level spreaders:

- Catch Basins and Inlets draining to a level spreader should be inspected and cleaned on an annual basis.
- The receiving land area should be immediately restored to design conditions after any disturbance. Vegetated areas should be seeded and blanketed.
- It is critical that even **sheet flow conditions** are sustained throughout the life of the level spreader, as their effectiveness can deteriorate due to lack of maintenance, inadequate design/location, and poor vegetative cover.
 - **Inspection** - The area below a level spreader should be inspected for clogging, density of vegetation, damage by foot or vehicular traffic, excessive accumulations, and channelization. Inspections should be made on a quarterly basis for the first two years following installation, and then on a semiannual basis thereafter. Inspections should also be made after every storm event greater than 1-inch.
 - **Removal** - Sediment and debris should be routinely removed (but never less than semiannually), or upon observation, when buildup occurs in the clean outs. Regrading and reseeded may be necessary in the areas below the level spreader. Regrading may also be required when pools of standing water are observed along the slope. (In no case should standing water be allowed for longer than 72 hours.)
 - **Vegetation** - Maintaining a vigorous vegetative cover on the areas below a level spreader is critical for maximizing pollutant removal efficiency and erosion prevention. If vegetative cover is not fully established within the designated time, it may need to be replaced with an alternative species. (It is standard practice to contractually require the contractor to replace dead vegetation.) Unwanted or invasive growth should be removed on an annual basis. Biweekly inspections are recommended for at least the first growing season, or until the vegetation is permanently established. Once the vegetation is established, inspections of health, diversity, and density should be performed at least twice per year, during both the growing and non-growing season. Vegetative cover should be sustained at 85% and replaced if damage greater than 50% is observed.

Cost Issues

As there are various types of level spreaders, their associated costs will vary. Per foot material and equipment cost will range from \$5 to \$20 depending on the type of level spreader desired. Concrete level spreaders may cost significantly more than perforated pipes or berms. (For more detailed cost information in BMP 6.4.4 Infiltration Trenches and BMP 6.4.10 Infiltration Berms.)

Specifications

The following specifications are provided for information purposes only. These specifications include information on acceptable materials for typical applications, but are by no means exclusive or limiting. The designer is responsible for developing detailed specifications for individual design projects in accordance with the project conditions.

1. **Stone** shall be 2-inch to 1-inch uniformly graded coarse aggregate, with a wash loss of no more than 0.5%, AASHTO size number 3 per AASHTO Specifications, Part I, 19th Ed., 1998, or later and shall have voids ³ 35% as measured by ASTM-C29.
2. **Non-Woven Geotextile** shall consist of needled non-woven polypropylene fibers and meet the following properties:
 - a. Grab Tensile Strength (ASTM-D4632) ³ 120 lbs
 - b. Mullen Burst Strength (ASTM-D3786) ³ 225 psi
 - c. Flow Rate (ASTM-D4491) ³ 95 gal/min/ft²
 - d. UV Resistance after 500 hrs (ASTM-D4355) ³ 70%
 - e. Heat-set or heat-calendared fabrics are not permitted
Acceptable types include Mirafi 140N, Amoco 4547, and Geotex 451.
3. **Topsoil** amend with compost (See BMP 6.7.3, Soil Amendment & Restoration)
4. **Pipe** shall be solid or continuously perforated, smooth interior, with a minimum inside diameter of 4-inches. High-density polyethylene (HDPE) pipe shall meet AASHTO M252, Type S or AASHTO M294, Type S.
5. **Vegetation** see Native Plant List in Appendix B.

References

Maine Department of Transportation, 1992. *Maine Department of Transportation BMP Manual for Erosion and Sedimentation Control*.

NC Division of Water Quality. *Level Spreader Design Suggestions*. October 10, 2001.

Idaho Department of Environmental Quality. *Idaho Catalog of Stormwater BMPs*.

Auckland Regional Council, 2003. *Stormwater Management Devices: Design Guidelines Manual*, Auckland, New Zealand

US EPA, NPDES, *Construction Site Storm Water Runoff Control – Permanent Diversions*

Designing Level Spreaders to Treat Stormwater Runoff (W.F. Hunt, D.E. Line, R.A. McLaughlin, N.B. Rajbhandari, R.E. Sheffield; North Carolina State University, 2001.)

BMP 6.8.2: Special Detention Areas – Parking Lot, Rooftop

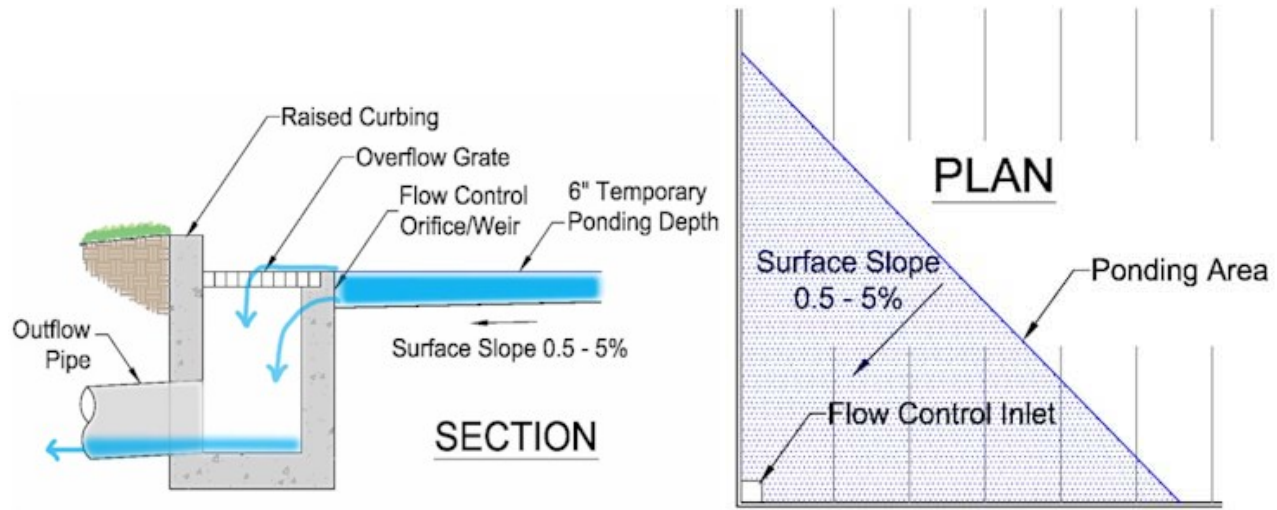

Areas such as parking lots and rooftops that are primarily intended for other uses but that can be designed to temporarily detain stormwater for peak rate mitigation.

<p style="text-align: center;"><u>Key Design Elements</u></p> <ul style="list-style-type: none"> ▪ Almost entirely for peak rate control ▪ Water quality and quantity are not addressed ▪ Short duration storage; rapid restoration of primary uses ▪ Minimize safety risks, potential property damage, and user inconvenience ▪ Emergency overflows ▪ Maximum ponding depths ▪ Flow control structures ▪ Adequate surface slope to outlet ▪ Waterproofing (rooftop storage) 	<p style="text-align: center;"><u>Potential Applications</u></p> <p>Residential: Limited Commercial: Yes Ultra Urban: Yes Industrial: Yes Retrofit: Yes Highway/Road: Limited</p> <hr/> <p style="text-align: center;"><u>Stormwater Functions</u></p> <p>Volume Reduction: Very Low Recharge: Very Low Peak Rate Control: Med./Low Water Quality: Low</p> <hr/> <p style="text-align: center;"><u>Water Quality Functions</u></p> <p>TSS: 0% TP: 0% NO3: 0%</p>
--	---

Description

Special Detention Areas are places such as parking lots and rooftops that are primarily intended for other uses but that can be designed to temporarily detain stormwater for peak rate mitigation. Generally detention is achieved through the use of a flow control structure that allows runoff to temporarily pond. In most cases, ponding depths should be kept less than one foot. Special Detention Areas can be very effective at reducing peak rates of runoff but do little in terms of water quality and almost nothing to reduce the volume of runoff. Therefore, Special Detention Areas should be combined with other BMPs that address water quality, quantity, and groundwater recharge.

Variations

Special Detention is especially suited for:

- Large gently-sloping parking lots



- Flat rooftops



- Recessed plazas



- Athletic fields



Applications

Detention areas can be created in parking lots in depressed areas or along curbs by controlling flow at stormwater inlets and/or using raised curbing. Rooftop runoff storage can be achieved by restricting flow at scuppers, drains, parapet wall openings, etc. Recessed plazas and athletic fields can be designed with detention through the use of flow control structures and/or berms (for fields). Special Detention Areas can be used effectively to attenuate flows reaching other BMPs and thereby increase their performance; they can also be used to meet release rate requirements from Act 167 plans or municipal ordinances.

Design Considerations

1. General

- a. Emergency overflows should be designed to prevent excessive depths from occurring during extreme events or if the primary flow control structures are clogged. Emergency overflows should be designed to safely convey flows downstream.
- b. Storage areas should be adequately sloped towards outlets to ensure complete drainage after storm events.
- c. Flow control structures should be designed to discharge stored runoff in a timely manner so that the primary use of the area can be restored.
- d. Care should be taken to ensure against ice build-up in the pooled area.

2. Parking Lot Storage

- a. Locate storage in areas so that ponding will not significantly disrupt typical traffic or pedestrian flow. Remote areas of large commercial parking lots, overflow parking areas, and other under-utilized parking areas are prime locations.
- b. Minimize potential safety risks and property damage due to ponding. Detention areas should be identified with signage or pavement markings or their use should be restricted during storms.
- c. Storage depths must be no greater than 1 foot.
- d. The area used for detention should be sloped towards the flow control structure at a least 0.5% to ensure adequate drainage after storms. Slopes greater than 5% tend to be inefficient because storage volume is much lower for a given ponding depth.

3. Rooftop Storage

- a. The roof structure must be able to support the additional load created by ponded water. Most roofs designed for snow load will be able to support runoff storage.
- b. Ponding depths should generally be less than 6 inches and stored water should not cause damage to any HVAC equipment on the roof.
- c. The areas utilized for storage must have adequate waterproofing.
- d. Emergency overflows can be provided by openings in the parapet wall or by additional drains.

Detailed Stormwater Functions

Volume Reduction Calculations

Special Detention Areas generally do not achieve significant volume reduction.

Peak Rate Mitigation Calculations

Peak rate of runoff is reduced in Special Detention Areas through the transient storage provided. See in Section 9 for Peak Rate Mitigation methodology.

Water Quality Improvement

Although they may provide some quality improvement through settling, Special Detention Areas do not appreciably address water quality.

Construction Sequence

Not applicable.

Maintenance Issues

Special Detention Areas generally require little maintenance. Maintenance activities should include semiannual inspection and cleaning of flow control structures, clearing debris/sediment from detention areas (as necessary), and inspecting waterproofing in rooftop storage areas.

Cost Issues

Special Storage Areas can be a very economical means of reducing peak rates of runoff because they require little additional material and take up no additional space on a site.

Specifications

The following specifications are provided for information purposes only. These specifications include information on acceptable materials for typical applications, but are by no means exclusive or limiting. The designer is responsible for developing detailed specifications for individual design projects in accordance with the project conditions.

1. Flow Control Structures

- a. Flow control structures shall be constructed of non-corrodible material.
- b. Structures shall be resistant to clogging by debris, sediment, floatables, plant material, or ice.
- c. Materials shall comply with applicable specifications (PennDOT or AASHTO, latest edition)

2. Waterproofing

- a. Waterproofing shall prevent all water migration into the building.
- b. Waterproofing must comply with applicable state and local building codes.
- c. Waterproofing shall have an expected service life of at least 25 years.

References

2001, Georgia Stormwater Management Manual; Volume Two: Technical Handbook

2003, Ontario Stormwater Management Planning & Design Manual

Iowa Statewide Urban Design Standards Manual

1992, Michigan - Index of Individual BMPs