

APPENDIX A

Level-of-Service and Queue Matrix Tables

Level-of-Service Matrix Tables

Welsh Road (S.R. 0063) and Jarrettown Road/Village Road

Time Period	Wednesday/Evening Peak Hour				Thursday/Midday Peak Hour						
	2015	2018		2023		2015	2018		2023		
Design Year	Existing	w/o Dev.	w/Dev.	w/o Dev.	w/Dev.	Existing	w/o Dev.	w/Dev.	w/o Dev.	w/Dev.	
Developing Condition	EB	Left	B	B	B	C	C	C	C	C	
		Thru	17.2	11.2	11.6	14.6	13.5	23.5	22.9	23.3	25.9
		Thru/Right	E	C	C	D	B	C	C	C	B
WB	Left/Thru/Right	Left	58.2	29.8	31.8	53.8	15.2	24.5	24.9	25.4	27.6
		Thru/Right	F	D	D	D	B	C	C	C	B
		Right	85.8	37.4	39.7	54.0	12.2	20.8	24.8	25.8	30.5
NB	Left/Thru/Right	Left	B	A	A	A	B	B	B	B	B
		Thru/Right	11.5	7.2	7.3	7.5	8.6	14.3	13.7	13.9	15.2
		Right	F	D	D	D	D	E	D	D	D
SB	Left/Thru/Right	Left	92.4	46.1	46.1	46.2	45.3	42.3	42.2	42.0	41.3
		Thru/Right	D	D	D	D	D	59.3	D	D	D
		Right	D	D	D	D	54.3	D	D	D	D
Overall	Average	Left	37.8	45.6	45.6	45.6	44.7	55.7	54.0	53.8	54.4
		Thru/Right	D	C	C	D	B	C	C	C	C
		Right	51.8	27.2	28.0	37.0	19.5	26.5	24.8	25.1	26.7
Village Road	Left/Thru/Right	Left	D	D	D	D	D	D	D	D	D
		Thru/Right	42.7	42.1	42.1	42.1	40.1	42.7	42.1	42.1	41.8
		Right	A	A	A	A	A	A	A	A	A
Jarrettown Road	Left/Thru/Right	Left	D	D	D	D	D	D	D	D	D
		Thru/Right	47.8	39.6	39.5	39.5	38.4	47.8	39.6	39.5	39.3
		Right	D	D	D	D	D	D	D	D	D
Welsh Road (S.R. 0063)	Left/Thru/Right	Left	A	A	A	A	A	A	A	A	A
		Thru/Right	5.0	5.3	5.4	5.5	7.4	5.0	5.3	5.4	5.5
		Right	A	B	B	B	9.1	A	B	B	B
Overall	Average	Left	9.2	10.2	10.3	10.3	9.1	9.2	10.2	10.3	10.9
		Thru/Right	A	A	A	A	A	A	A	A	A
		Right	5.4	6.3	6.3	6.9	5.4	5.4	6.3	6.3	6.9

Level-of-Service Matrix Tables

Welsh Road (S.R. 0063) and Dresher Road

Time Period Design Year	Wednesday Morning Peak Hour			Wednesday Afternoon Peak Hour			Saturday Morning Peak Hour					
	2015	2018		2018		2018		2018		2023		
Development Condition	Existing	w/o Dev.	w/Dev.	Existing	w/o Dev.	w/Dev.	Existing	w/o Dev.	w/Dev.	Existing	w/o Dev.	w/Dev.
EB Welsh Road (S.R. 0063)	Left	C	C	C	D	D	A	A	A	A	A	B
	Thru	31.4	25.6	A	39.1	B	B	33.9	B	6.5	6.5	10.1
	Thru	6.3	6.2	6.4	17.8	17.9	17.9	17.8	5.5	5.5	5.2	6.7
WB Welsh Road (S.R. 0063)	Thru	B	D	D	C	D	C	D	B	B	B	B
	Thru	18.7	37.6	39.7	23.9	37.4	37.6	37.4	14.2	14.3	14.8	19.3
	Right	4.6	14.7	15.9	1.9	6.8	6.8	6.8	2.5	2.5	2.6	3.8
SB Dresher Road	Left	D	D	D	F	D	D	D	D	D	D	D
	Left	48.7	52.6	54.2	106.0	51.4	51.9	51.4	41.2	41.2	40.7	39.8
	Right	26.6	13.6	13.3	28.8	17.7	17.6	17.5	6.0	6.1	6.8	10.6
Overall	27.1	25.7	25.8	43.9	29.4	29.6	31.0	12.7	12.8	12.8	15.3	

Level-of-Service Matrix Tables

Dreshertown Road (S.R. 2024) and Site Access

Time Period	Weekday Morning Peak Hour				Weekday Afternoon Peak Hour				Saturday Afternoon Peak Hour			
	2015	2018		2023	2015	2018		2023	2015	2018		2023
Design Year	Existing	w/o Dev.	w/Dev.	w/Dev.	Existing	w/o Dev.	w/Dev.	w/Dev.	Existing	w/o Dev.	w/Dev.	w/Dev.
Development Condition	(1)	(1)	C	D	(1)	(1)	D	D	(1)	(1)	B	D
				53.9				54.7				42.7
Site Access	(1)	(1)	24.6	D	(1)	(1)	30.6	D	(1)	(1)	13.6	D
				47.3				48.7				39.5
Dreshertown Road (S.R. 2024)	(1)	(1)	(2)	A	(1)	(2)	(2)	A	(1)	(1)	(2)	A
				5.5				7.8				5.2
Overall	(1)	(1)	(2)	A	(1)	(2)	(2)	A	(1)	(1)	(2)	A
				3.2				3.6				4.2
Overall	(1)	(1)	A	A	(1)	A	A	B	(1)	(1)	A	A
				7.9				13.9				8.0
Overall	(1)	(1)	0.1	A	(1)	0.1	0.1	A	(1)	(1)	0.1	A
				8.1				8.7				4.9
Overall	(1)	(1)	A	B	(1)	A	A	B	(1)	(1)	A	B
				11.2				13.3				12.6

(1) Movement does not exist

(2) Movement operates at free flow

Level-of-Service Matrix Tables

Welsh Road (S.R. 0063) and RIRO Access

Time Period Design Year	Weekly Morning Peak Hour		Weekly Afternoon Peak Hour		Sunday Midday Hour	
	2015	2018	2015	2018	2015	2023
Development Condition	Existing	w/o Dev.	w/Dev.	w/o Dev.	w/Dev.	w/Dev.
	(1)	(1)	(1)	(1)	(1)	(2)
EB	Thru/Thru	(1)	(1)	(1)	(1)	(2)
	Right	(1)	(1)	(1)	(1)	(2)
WB	Thru	(1)	(1)	(1)	(1)	(2)
	Thru/Right	(1)	(1)	(1)	(1)	(2)
NB	Right	(1)	(1)	(1)	(1)	C
						15.8
Overall	(1)	(1)	(1)	(1)	(1)	A 0.7

Time Period Design Year	Weekly Morning Peak Hour		Weekly Afternoon Peak Hour		Sunday Midday Hour	
	2015	2018	2015	2018	2015	2023
Development Condition	Existing	w/o Dev.	w/Dev.	w/o Dev.	w/Dev.	w/Dev.
	(1)	(1)	(1)	(1)	(1)	(2)
EB	Thru/Thru	(1)	(1)	(1)	(1)	(2)
	Right	(1)	(1)	(1)	(1)	(2)
WB	Thru	(1)	(1)	(1)	(1)	(2)
	Thru/Right	(1)	(1)	(1)	(1)	(2)
NB	Right	(1)	(1)	(1)	(1)	C
						21.8
Overall	(1)	(1)	(1)	(1)	(1)	A 0.4

Time Period Design Year	Weekly Morning Peak Hour		Weekly Afternoon Peak Hour		Sunday Midday Hour	
	2015	2018	2015	2018	2015	2023
Development Condition	Existing	w/o Dev.	w/Dev.	w/o Dev.	w/Dev.	w/Dev.
	(1)	(1)	(1)	(1)	(1)	(2)
EB	Thru/Thru	(1)	(1)	(1)	(1)	(2)
	Right	(1)	(1)	(1)	(1)	(2)
WB	Thru	(1)	(1)	(1)	(1)	(2)
	Thru/Right	(1)	(1)	(1)	(1)	(2)
NB	Right	(1)	(1)	(1)	(1)	C
						16.0
Overall	(1)	(1)	(1)	(1)	(1)	A 0.3

(1) Intersection not studied under these conditions

(2) Movement operates at free flow

(3) Movement does not exist

95th Percentile Queue Matrix Tables

Welsh Road (S.R. 0063) and Jarrettown Road

Time Period	Daily Morning Peak Hour		Daily Afternoon Peak Hour		2018		2023	
	2015		2018		2018		2023	
	Existing	w/o Dev.	w/o Dev.	w/Dev.	w/o Dev.	w/Dev.	w/o Dev.	w/Dev.
Development Condition	Left	50	43	43	23	23	25	28
	Thru	1,165	930	958	733	798	845	368
	Thru/Right							380
WB	Left	473	395	398	210	248	250	173
	Thru/Right	443	375	378	725	738	740	940
	Left/Thru	595	110	110	58	58	60	58
NB	Right		410	405	373	298	298	320
	Left/Thru/Right	68	75	75	323	320	320	328
Jarrettown Road	Left	43	50	50	43	50	55	65
	Thru/Right	218	238	238	218	238	238	330
	Left/Thru	123	13	13	13	13	13	13
Village Drive	Right		123	123		123	123	165
	Left/Thru/Right	23	23	23	23	23	23	23

(1) Intersection not studied under these conditions

(2) Center gore area can accommodate a total of approximately 280 feet of storage without impacting other movements

95th Percentile Queue Matrix Tables

Welsh Road (S.R. 0063) and Dresher Road

Panel/Portion	Existing Storage (feet)		Proposed Storage (feet)		Weekly Morning Peak Hour						Weekly Afternoon Peak Hour						Saturday Midday Peak Hour																											
	Design Year	Development Condition	Existing	Proposed	2015		2018		2023		2015		2018		2023		2015		2018		2023																							
					w/o Dev.	w/Dev.	w/o Dev.	w/Dev.	w/o Dev.	w/Dev.	w/o Dev.	w/Dev.	w/o Dev.	w/Dev.	w/o Dev.	w/Dev.	w/o Dev.	w/Dev.	w/o Dev.	w/Dev.	w/o Dev.	w/Dev.																						
Welsh Road (S.R. 0063)	EB	Thru	---	225	330	724	226	243	432	211	211	228	211	367	51	51	92	100	101	52	49	53																						
																							Thru	---	380	98	101	205	315	318	314	100	101	120										
																																			Thru	---	269	362	367	434	398	401	440	158
Welsh Road (S.R. 0063)	WB	Thru	---	228	379	364	406	64	202	203	218	199	82	72	72	30	72	72	49	49	49																							
																						Thru	---	228	379	364	406	64	202	203	218	199	82	72	72	30	72	72	49	49	49			
																																										Right	210	228
Dresher Road	SB	Left	≥ 1000 ⁽¹⁾	≥ 1000 ⁽¹⁾	309	344	347	408	450	456	475	544	457	450	456	457	138	150	151	150	152	200																						
																							Left	415	222	160	160	167	172	261	261	272	276	314	261	261	314	457	138	150	151	150	152	200

(1) Distance to adjacent signalized intersection

95th Percentile Queue Matrix Tables

Welsh Road (S.R. 0063) and Dreshertown Road (S.R. 2024)

Time Period Designation	2015		2018		2023		2015		2018		2023		2015		2018		2023		
	Existing	w/o Dev.	w/Dev. & Imps	w/o Dev.	w/Dev.	w/o Dev.	w/Dev.	Existing	w/o Dev.	w/Dev.	w/o Dev.	w/Dev.	Existing	w/o Dev.	w/Dev.	w/o Dev.	w/Dev.	w/o Dev.	w/Dev.
Development Condition BB Welsh Road (S.R. 0063)	Thru	78	10	10	10	10	10	1,843	623	625	648	648	25	8	8	10	13		
	Thru	138	25	30	28	33	33	1,985	653	675	688	685	25	5	5	5	8		
	Right																		
Development Condition WB Welsh Road (S.R. 0063)	Left	303	285	280	288	273	273	568	593	595	610	525	133	123	123	128	105		
	Thru/Thru	8	8	8	8	10	10	8	8	8	8	10	5	5	5	5	8		
Development Condition NB Dreshertown Road (S.R. 2024)	Left	188	215	213	218	240	240	270	288	295	308	365	93	113	115	115	183		
	Left																		
	Right	315	370	348	375	285	285	408	430	430	448	373	238	280	280	290	225		

(1) 650' queue can be accommodated in the existing center left-turn lane along Welsh Road

(2) Distance to adjacent signalized intersection

95th Percentile Queue Matrix Tables

Welsh Road (S.R. 0063) and Dryden Road⁽¹⁾

Time Period Development Contribution	Existing Storage (feet)	Proposed Storage (feet)	Weekday Morning Peak Hour				Weekday Afternoon Peak Hour				Saturday Morning Peak Hour					
			2015		2018		2018		2023		2015		2018		2023	
			Existing	w/o Dev.	w/o Dev.	w/Dev.	Existing	w/o Dev.	w/o Dev.	w/Dev.	Existing	w/o Dev.	w/o Dev.	w/Dev.		
EB Welsh Road (S.R. 0063)	Left	150	0	0	0	0	0	0	0	0	0	0	0	0	0	0
	Thru	---	3	8	8	8	8	8	8	8	8	8	8	8	8	13
	Right	225	0	3	3	0	0	0	3	0	0	0	0	0	0	3
WB Welsh Road (S.R. 0063)	Left	175 ⁽²⁾	15	15	18	15	15	15	195	0	0	5	0	410	0	468
	Thru	---	208	213	243	225	313	313	348	295	313	313	328	348	145	265
	Thru/Right	---	215	220	253	235	0	0	0	0	0	0	0	150	150	275
NB Dryden Road	Left	110	3	3	8	3	148	150	170	148	148	150	148	338	3	305
	Thru/Right	---	0	0	20	0	25	33	200	25	25	33	25	268	3	258
	Left	150	3	3	3	3	5	5	3	5	5	5	5	5	3	3
Thru/Right	---	0	0	0	0	3	3	0	3	3	3	3	3	3	3	3

(1) It is recommended that the NB left-turn lane on Dryden Road and WB left-turn lane on Welsh Road (S.R. 0063) be extended to accommodate development

of the Prudential Lot 3 site when a detailed development plan of that site is determined

(2) 500+ queue can be accommodated in the existing center left-turn lane along Welsh Road

95th Percentile Queue Matrix Tables

Welsh Road (S.R. 0063) and RIRO Access

Line Period Design Year Development Condition	Existing Storage (feet)	Proposed Storage (feet)	Weekly Morning Peak Hour									
			2015		2018		2023					
			Existing	w/o Dev.	w/o Dev.	w/Dev.	w/o Dev.	w/Dev.				
EB Welsh Road (S.R. 0063)	Thru/Thru	---	(1)	(1)	(1)	(1)	(1)	(1)	(1)	(1)	(1)	
	Right	---	(1)	(1)	(1)	(1)	(1)	(1)	(1)	(1)	(1)	
WB Welsh Road (S.R. 0063)	Thru	---	(1)	(1)	(1)	(1)	(1)	(1)	(1)	(1)	(1)	
	Thru/Right	---	(1)	(1)	(1)	(1)	(1)	(1)	(1)	(1)	(1)	
NB RIRO Access	Right	---	(1)	(1)	(1)	(1)	(1)	(1)	(1)	(1)	(1)	
		---	(1)	(1)	(1)	(1)	(1)	(1)	(1)	(1)	(1)	
											25	
												28

(1) Movement does not exist

(2) Movement operates at free flow

(3) Movement does not exist

APPENDIX B

Study Area Sketches and Signal Permit Plan

Job _____ McMahon Project No. _____ Sheet _____ of _____
 Description WELSH RD + Designed By NBS/BV Date _____
DAETKEN RD Checked By _____ Date _____

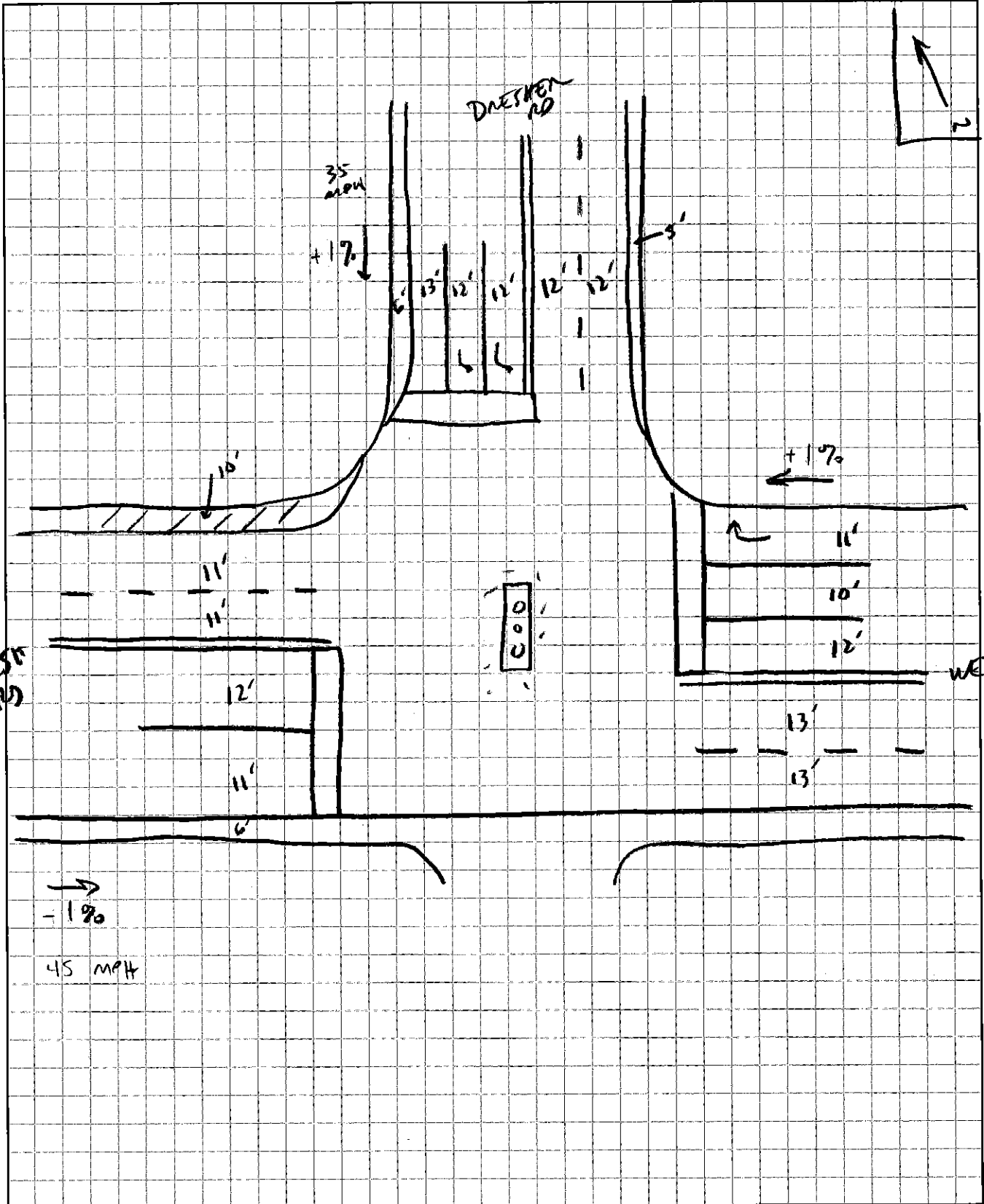

Job _____ McMahan Project No. _____ Sheet _____ of _____
 Description WEIGHT AS + Designed By NSB/aw Date _____
DRASHINGTON AS Checked By _____ Date _____

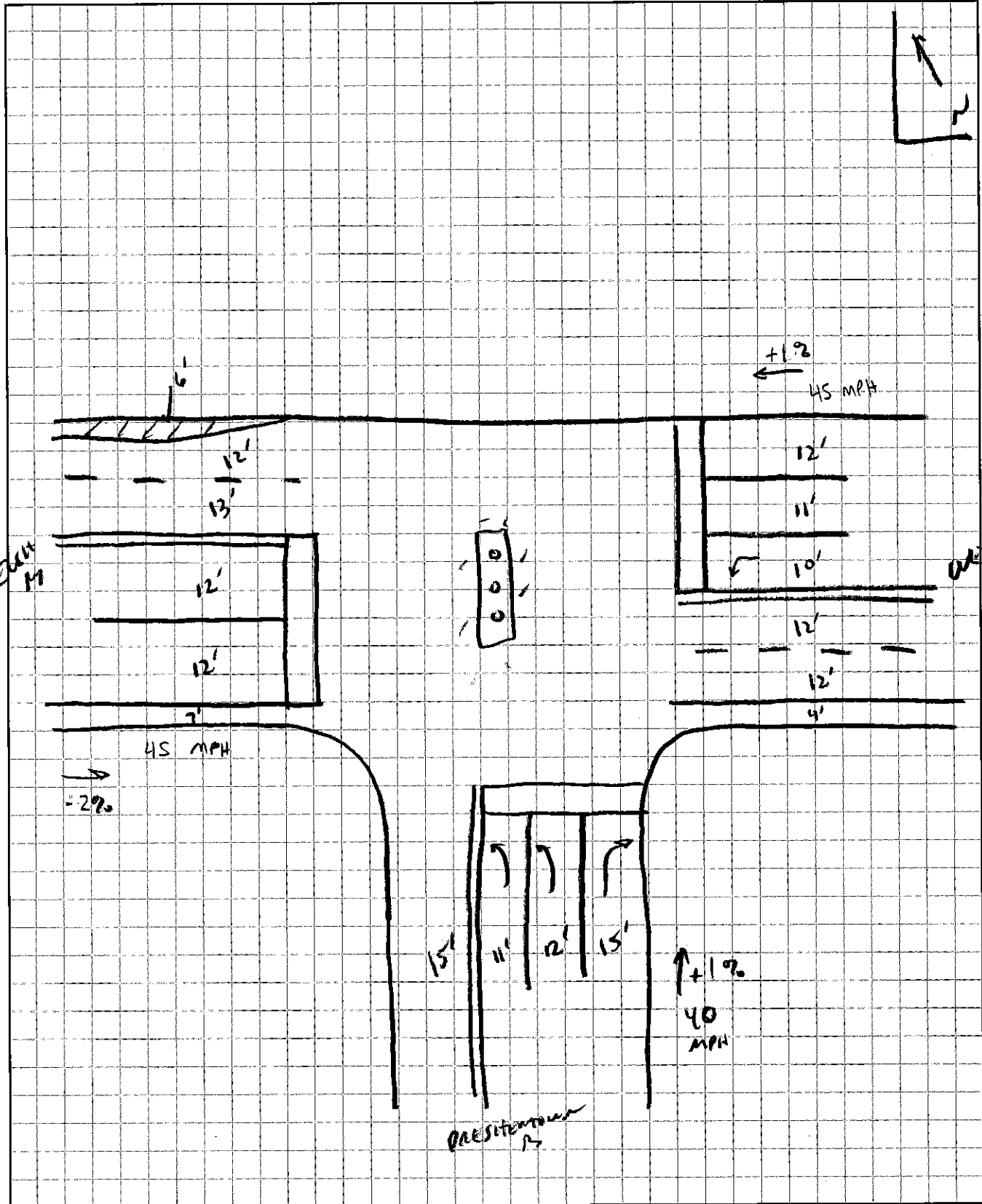

Job _____ McMahon Project No. _____ Sheet _____ of _____

Description WELSH RD + Designed By NSD/BW Date _____

DAYDEN RD Checked By _____ Date _____

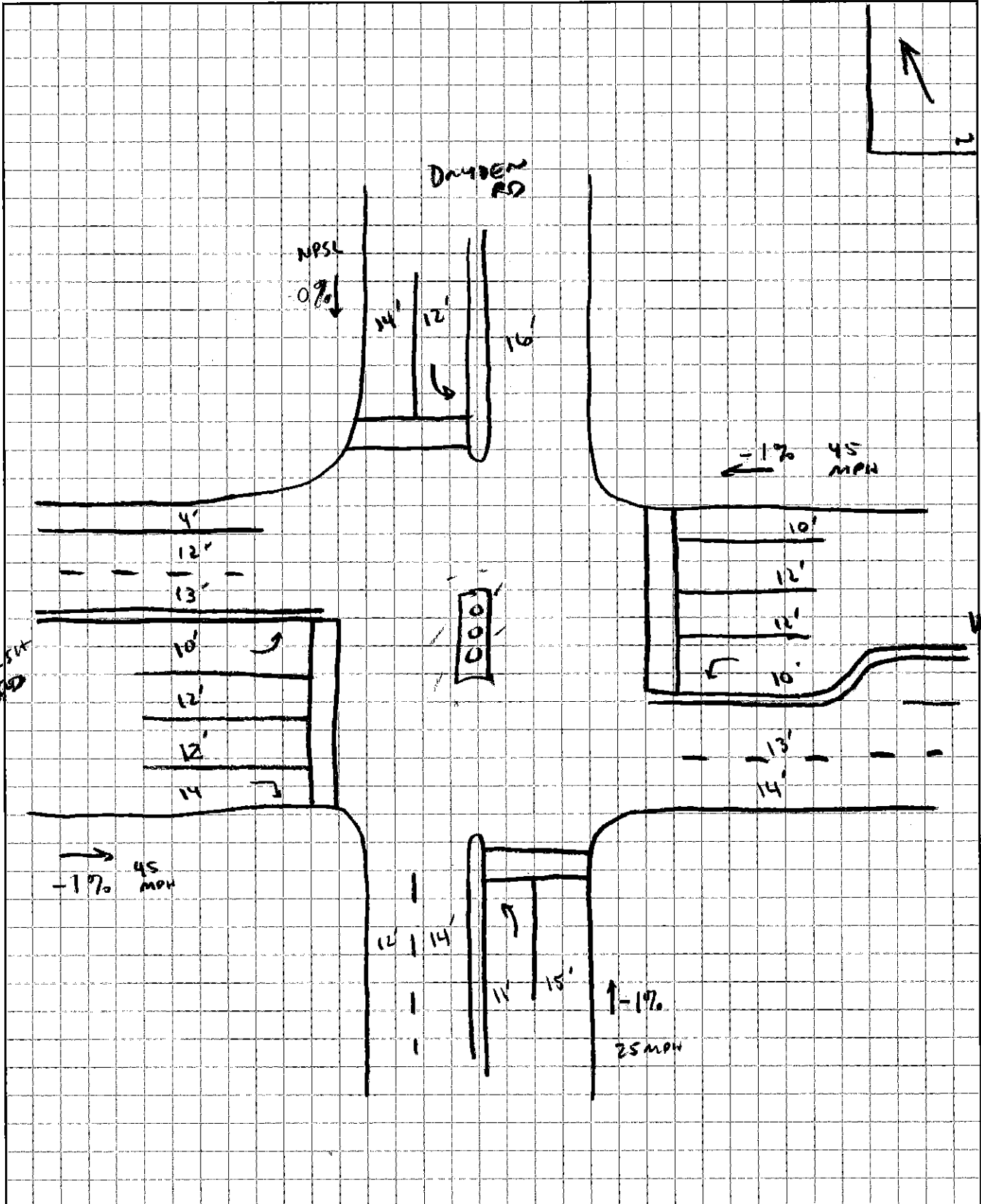

SIGN TABULATION			
PLAN SYMBOL	SERIES NUMBER	SIZE	REMARKS
A	R10-6AL	24"x30"	STOP HERE ON RED
B	R3-7L	30"x30"	LEFT LANE MUST TURN LEFT
C	R10-3E(R)	9"x15"	EDUCATIONAL PUSH BUTTON
D	R10-3E(L)	9"x15"	EDUCATIONAL PUSH BUTTON
E	R10-12	30"x36"	LEFT TURN YIELD ON GREEN
F	D3-4	72"x16"	Welsh Rd
G	R10-10R	30"x36"	RIGHT TURN SIGNAL
H	D3-5	96"x28"	Jarrettown Rd/Village Rd
J***	W3-3	48"x48"	RED SIGNAL AHEAD
K	D3-5	96"x28"	Jarrettown Rd / Village Rd
L	OM-3R	12"x36"	RIGHT CLEARANCE MARKER
M	R3-7R	30"x30"	RIGHT LANE MUST TURN RIGHT

*** SEE SHEET 3 OF 3 "DETAIL RED SIGNAL AHEAD"

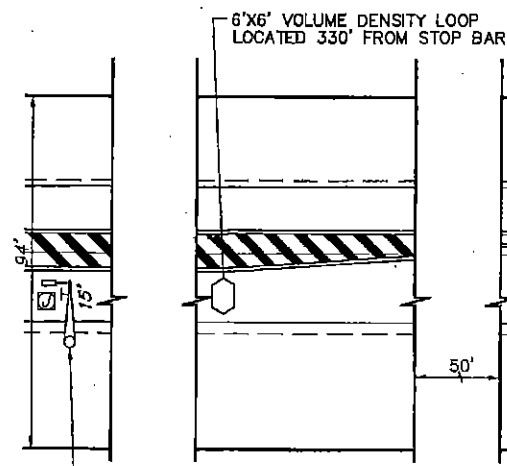

SIGN "J" LOCATED APPROX. 425' FROM STOP BAR

MOVEMENT, SEQUENCE AND TIMING DIAGRAM

PHASE	1+6				2+6				4+8				FLASH
	1	2	3	4	5	6	7	8	9	10	11	12	
SIGNALS	G	G	Y	R	G	G	Y	R	R	R	R	R	Y
1,2	G	G	Y	R	G	G	Y	R	R	R	R	R	Y
3	G	G	Y	R	G	G	Y	R	R	R	R	R	Y
4,5	R	R	R	R	G	G	Y	R	R	R	R	R	Y
6,7,8	R	R	R	R	R	R	R	R	G	G	Y	R	Y
9	R	R	R	R	R	R	R	R	G	G	Y	R	Y
10,11,12	R	R	R	R	R	R	R	R	G	G	Y	R	Y
13,14	M	FH	H	H	M	FH	H	H	H	H	H	H	OFF
15,16	H	H	H	H	M	FH	H	H	H	H	H	H	OFF
17,18	H	H	H	H	H	H	H	H	M	FH	H	H	OFF
19,20	H	H	H	H	H	H	H	H	M	FH	H	H	OFF
SIGN "J"													
"RED"	ON	ON	ON	ON	OFF	F	ON	ON	ON	ON	ON	ON	OFF
"SIGNAL AHEAD"	ON	ON	ON	ON	ON	ON	ON	ON	ON	ON	ON	ON	OFF

* UPON PEDESTRIAN ACTUATION, OTHERWISE HAND SYMBOL AT ALL TIMES

OPERATION NOTES:

- 1 G/Y IF FOLLOWED BY 2+6
 - 2 G IF FOLLOWED BY 2+6
 - 3 M IF FOLLOWED BY 2+6
 - 4 TIMING WILL BE SHOWN AS IN PHASE 2+6. INTERVALS MAY TIME OUT IN THIS PHASE OR MAY BE COMPLETED IN PHASE 2+6
 - 5 MINIMUM GREEN TIME. ACTUAL TIME DETERMINED BY COORDINATION.
- F=FLASHING RED
 (+) 'RED' IS ON FOR FIRST 4 SECONDS OF INTERVAL #5, FLASHES FOR 8 SECONDS BEFORE TERMINATING GREEN INTERVAL.

REFER TO SYSTEM PERMIT # I-DD98 FOR PROGRAM TIMINGS AND WEEKLY PROGRAM CHARTS.

SIGNAL INDICATIONS

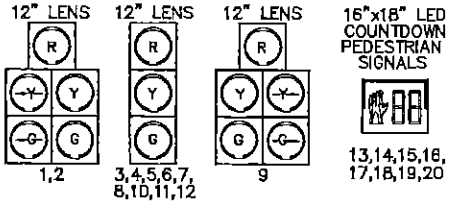

SIGNALS TO BE EQUIPPED WITH TUNNEL VISORS & LOUVERS

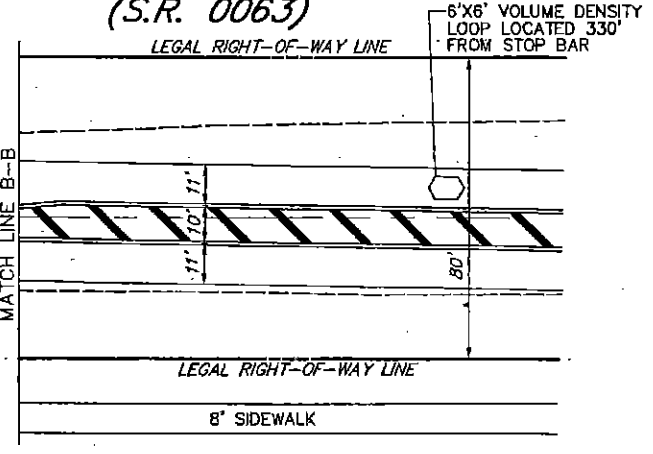
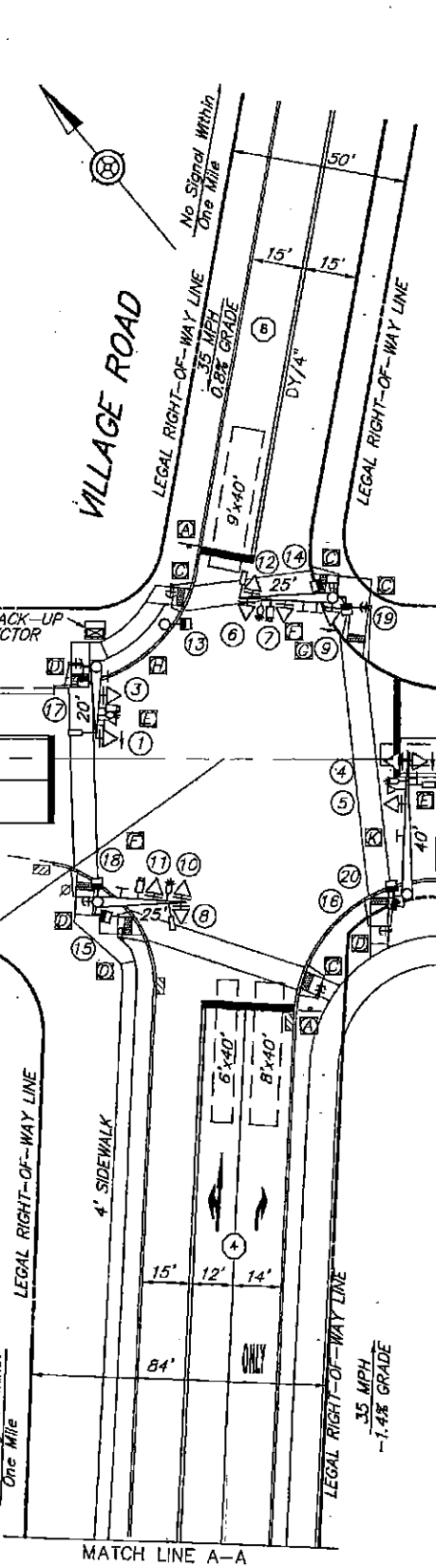
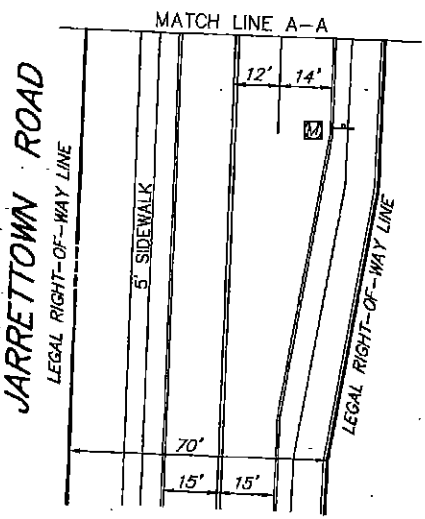

TOTALS		TOTALS	
1. 7:00AM TO 8:00AM	76	53	33
2. 8:00AM TO 9:00AM			
3. 9:00AM TO 10:00AM			
4. 10:00AM TO 11:00AM			
5. 11:00AM TO 12:00PM			
6. 12:00PM TO 1:00PM			
7. 1:00PM TO 2:00PM			
8. 2:00PM TO 3:00PM			
9. 3:00PM TO 4:00PM			
10. 4:00PM TO 5:00PM			
11. 5:00PM TO 6:00PM			
12. 6:00PM TO 7:00PM			

2016 PROJECTED TRAFFIC VOLUMES

GENERAL NOTES

NO MODIFICATIONS OF THIS INSTALLATION ARE PERMITTED UNLESS PRIOR APPROVAL IS GRANTED IN WRITING BY A REPRESENTATIVE OF THE DEPARTMENT OF TRANSPORTATION.

ALL MAINTENANCE WORK INCLUDING TRIMMING OF TREES, NECESSARY FOR PROPER VISIBILITY OF THE SIGNALS IS THE RESPONSIBILITY OF THE PERMITTEE.

ALL SIGNS AND PAVEMENT MARKINGS INDICATED ON THIS DRAWING ARE CONSIDERED PART OF THE PERMIT AND SHALL BE INSTALLED AND MAINTAINED IN ACCORDANCE WITH PUBLICATION NO. 212.

POST MOUNTED SIGNALS SHALL BE INSTALLED WITH THE SIGNAL HEADS A MINIMUM OF 2 FEET BEHIND THE FACE OF CURB OR THE EDGE OF THE SHOULDER. SUPPORT POLES FOR OVERHEAD SIGNALS SHALL ALSO HAVE A MINIMUM CLEARANCE HORIZONTALLY OF 2 FEET.

SIGNALS ERECTED OVER THE ROADWAY SHALL HAVE A MINIMUM VERTICAL CLEARANCE OF 16 FT, ABOVE THE ROADWAY. POST MOUNTED SIGNALS SHALL BE A MINIMUM OF 8 FT. ABOVE THE SIDEWALK OR PAVEMENT.

ALL OVERHEAD SIGNALS MUST BE RIGIDLY MOUNTED, TOP AND BOTTOM, AND EQUIPPED WITH BACKPLATES.

THE MINIMUM HORIZONTAL DISTANCE BETWEEN SIGNALS MEASURED AT RIGHT ANGLES TO THE APPROACH SHALL BE 6 FEET.

EXACT LOCATION OF DETECTORS SHALL BE DETERMINED PRIOR TO INSTALLATION BY A REPRESENTATIVE OF PENNDOT.

CURBING TO BE INSTALLED BY MUNICIPALITY AND WHERE NOTED, SHALL BE PLAIN CEMENT CONCRETE OR GRANITE CURB, INSTALLED IN ACCORDANCE WITH DEPARTMENT SPECIFICATIONS FORM 408.

PRIOR TO INSTALLATION THE CONTRACTOR SHALL CONSULT WITH THE LOCAL OFFICIALS AND UTILITY COMPANIES TO RESOLVE ANY PROBLEMS WHICH MAY BE CREATED DUE TO THE LOCATION OF UTILITIES.

THIS DRAWING CANNOT BE USED AS A CONSTRUCTION DRAWING UNLESS THE PERMITTEE COMPLIES WITH THE PROVISIONS OF THE LATEST AMENDMENT TO ACT 287, PREVENTION OF DAMAGE TO UNDERGROUND UTILITIES, DATED DECEMBER 20, 1974.

WHEN LIQUID FUELS MONEY IS USED, SIGNAL INSTALLATION MUST CONFORM TO FORM 408 AND A COPY OF THE PROPOSED SPECIFICATIONS MUST BE SUBMITTED TO THE DISTRICT TRAFFIC UNIT, FOR REVIEW, PRIOR TO BIDDING.

PERMITTEE SHALL OBTAIN A HIGHWAY OCCUPANCY PERMIT FOR ANY CHANGES IN INTERSECTION GEOMETRY REGARDING EXCAVATION.

CONDUIT INSTALLED IN BITUMINOUS ROADWAY LESS THAN 5 YEARS OLD, OR CONCRETE ROADWAY REGARDLESS OF AGE, MUST BE BORED OR JACKED UNDER THE ROADWAY. INSTALL IN ACCORDANCE WITH TRAFFIC SIGNAL STANDARDS TC-8800 SERIES.

SYSTEM PERMIT # I-0098

PENNSYLVANIA DEPARTMENT OF TRANSPORTATION
ENGINEERING DISTRICT 6-0

COUNTY: MONTGOMERY
MUNICIPALITY: HORSHAM & UPPER DUBLIN TWPS.
INTERSECTION: WELSH ROAD (SR 0063)
& JARRETTOWN ROAD/VILLAGE ROAD

REVIEWED: *White* 7/8/2015
DATE

MUNICIPAL OFFICIAL: _____ DATE: _____
RECOMMENDED: **MARK L. KRAY** 5-23-97
MUNICIPAL SIGNALS ENGINEER: **DOUGLAS MAY** 5-23-97
DISTRICT TRAFFIC ENGINEER: _____ DATE: _____

NO.	REVISION	DES. REV.	DATE	REVW.	DATE	RECOM.	DATE
1	NEW CADD DWG/TIMING UPDATE	CB	4/23/98	MK	4/23/98	DWM	4/29/98
2	CHANGE V/D TIMINGS	NU	4/20/00	MK	4/20/00	WJE	5/14/00
3	REV. COORD.	TPD	1/10/05	MK	1/30/05	LRB	2/1/05
4	ADD. NB RT LANE, EXP. TIMING IMPR. VIDEO DET.	BURNS	6/17/05	DJA	7/14/05	WJE	7/15/05
5							
6							
7							
8							

EMERGENCY PRE-EMPTION MOVEMENT, SEQUENCE AND TIMING DIAGRAM

PHASE	6			2			4			8		
INTERVAL	13	14	15	16	17	18	19	20	21	22	23	24
1,2	G	Y	R	R	R	R	R	R	R	R	R	R
3	G	Y	R	R	R	R	R	R	R	R	R	R
4,5	R	R	R	G	Y	R	R	R	R	R	R	R
6,7,8	R	R	R	R	R	R	G	Y	R	R	R	R
9	R	R	R	R	R	R	G	Y	R	R	R	R
10,11,12	R	R	R	R	R	R	R	R	R	G	Y	R
13,14	H	H	H	H	H	H	H	H	H	H	H	H
15,16	H	H	H	H	H	H	H	H	H	H	H	H
17,18	H	H	H	H	H	H	H	H	H	H	H	H
19,20	H	H	H	H	H	H	H	H	H	H	H	H
SIGN J 'RED'	ON	ON	ON	OFF	OFF	OFF	ON	ON	ON	ON	ON	ON
FIXED	**	5	2	**	5	2	**	4	2	**	4	2

OPERATION NOTES:
 (a) G/Y IF FOLLOWED BY 2+6
 (b) G IF FOLLOWED BY 2+6

** DURATION OF PRE-EMPTION

NOTE: IF PRE-EMPTION EQUIPMENT HAS ENCODING CAPABILITIES FOR VEHICLE IDENTIFICATION, IT IS RECOMMENDED TO HAVE THE "OD" FEATURE ON, TO GIVE UNCODED EMITTERS THE ABILITY TO ACTIVATE THE EMERGENCY PRE-EMPTION.

EMERGENCY PRE-EMPTION NOTES:

- * CONTROLLER TO BE EQUIPPED WITH EMERGENCY PRE-EMPTION FOR THE NORTHBOUND APPROACH OF JARRETTOWN ROAD, THE SOUTHBOUND APPROACH OF VILLAGE ROAD AND THE EASTBOUND AND WESTBOUND APPROACHES OF WELSH ROAD WITH A FAIL SAFE DEVICE FOR EACH DIRECTION OF OPERATION.
- THIS EMERGENCY BEACON SHALL CONSIST OF A FLASHING WHITE FLOOD LIGHT, AND SHALL FLASH WHEN THE EMERGENCY VEHICLE HAS CONTROL OF THE INTERSECTION FOR THE APPROPRIATE APPROACH. LOCATION OF THE EMERGENCY VEHICLE DETECTORS ARE TO BE FIELD ADJUSTED TO ACHIEVE MAXIMUM OPERATION.
- * THE SIGNALS, WHEN ACTIVATED BY EMERGENCY VEHICLES, SHALL TERMINATE ALL GREEN INDICATIONS IMMEDIATELY, FOLLOWED BY THE COMPLETE YELLOW AND RED CLEARANCE INTERVALS, ACCORDINGLY. THEN THE GREEN INTERVAL FOR THE PRE-EMPTED PHASE SHALL FOLLOW.
- * THE SIGNALS, WHEN ACTIVATED BY EMERGENCY VEHICLE SHALL TIME OUT ALL YELLOW, HAND/MAN AND RED INDICATIONS, FOLLOWED BY THE GREEN INTERVAL OF THE PRE-EMPTION PHASE GOVERNED BY THE APPROACHING EMERGENCY VEHICLE.
- * IF THE SIGNAL HAS BEEN ACTUATED BY PEDESTRIAN PUSHBUTTON, AND THE SIGNAL IS PRE-EMPTED DURING THE "MAN" INTERVAL, THE MAN INTERVAL SHALL TERMINATE IMMEDIATELY FOLLOWED BY THE "FLASHING HAND" INDICATION IN ITS ENTIRETY, FOLLOWED BY THE APPROPRIATE SELECTIVE CLEARANCES BEFORE PROCEEDING TO THE PRE-EMPTION PHASE.
- * IF THE SIGNALS, WHEN ACTIVATED BY AN EMERGENCY VEHICLE ARE FLASHING, ALL SIGNALS SHALL REMAIN FLASHING.
- * IF ADDITIONAL PRE-EMPTION, PHASES ARE ACTIVATED WHILE IN PRE-EMPTION, THE ORIGINAL PRE-EMPTION PHASE SHALL TIME OUT BEFORE PROCEEDING TO THE NEXT PRE-EMPTION PHASE.
- * UPON COMPLETION OF PRE-EMPTION PHASES 2,4,6,8 IN RETURNING TO NORMAL OPERATION, PHASE 2+6 INTERVAL 4 SHALL FOLLOW.
- * IN EMERGENCY PRE-EMPTION, NO PRIORITY SHALL BE ESTABLISHED. PRE-EMPTION SHALL BE A "FIRST COME, FIRST SERVE" OPERATION.

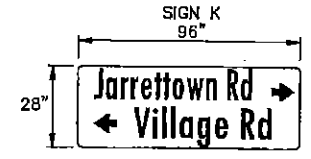

N.T.S.
 CLEARVIEW-ONE 1-W
 10.6" UPPER CASE
 8" LOWER CASE LETTERS

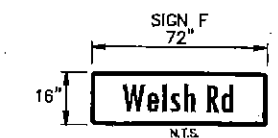

N.T.S.
 CLEARVIEW-ONE 1-W
 8" UPPER CASE
 6" LOWER CASE LETTERS

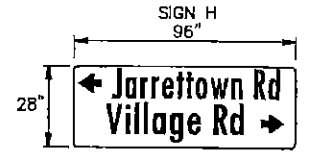

N.T.S.
 CLEARVIEW-ONE 1-W
 10.6" UPPER CASE
 8" LOWER CASE LETTERS

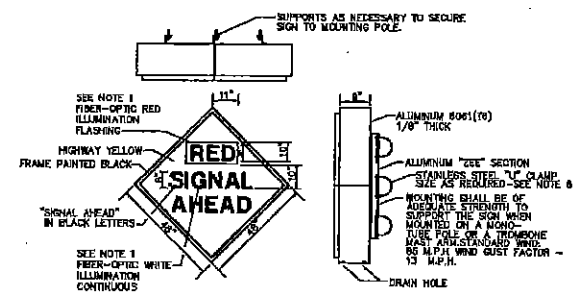

DETAIL "RED SIGNAL AHEAD" SIGN "V" MOUNTING ARRANGEMENTS NOT TO SCALE

GENERAL NOTES FOR "RED SIGNAL AHEAD" SIGN

- "RED SIGNAL AHEAD" SIGN SHALL BE FIBER-OPTIC WITH A MINIMUM OF TWO (2) LAMPS REQUIRED FOR EACH LINE OF THE SIGN LEGEND.
- THE FIBER-OPTIC BUNDLES SHALL BE ARRANGED SO THAT FAILURE OF ONE LAMP WILL NOT EXTINGUISH THE LINE OF THE LEGEND.
- "SIGNAL AHEAD" TO BE CONTINUOUSLY ILLUMINATED.
- THE WORD "RED" TO BE ILLUMINATED IN A FLASHING MODE AND AS SPECIFIED IN THE OPERATIONAL CHART.
- THE WORD "RED" SHALL NOT BE VISIBLE DURING THE GREEN INTERVAL.
- THE SIGN CASE SHALL BE FULLY SEALED AND WATER TIGHT.

OPERATIONAL NOTES:

- WHEN ACTIVATED, THE WORD "RED" SHALL FLASH 8 SECONDS BEFORE THE TERMINATION OF THE GREEN INTERVAL (INTERVAL 6) AND DURING THE ENTIRE YELLOW INTERVAL (INTERVAL 7).
- DURING THE INTERVALS 1,2,3,4,8,9,10,11 AND 12 THE "RED" SHALL BE A STEADY BURN OPERATION.
- (+) SIGN IS ON FOR FIRST 4 SECONDS OF INTERVAL #5, FLASH "RED" FOR 8 SECONDS AS INDICATED IN NOTE A.

GENERAL NOTES

NO MODIFICATIONS OF THIS INSTALLATION ARE PERMITTED UNLESS PRIOR APPROVAL IS GRANTED IN WRITING BY A REPRESENTATIVE OF THE DEPARTMENT OF TRANSPORTATION.

ALL MAINTENANCE WORK INCLUDING TRIMMING OF TREES, NECESSARY FOR PROPER VISIBILITY OF THE SIGNALS IS THE RESPONSIBILITY OF THE PERMITTEE.

ALL SIGNS AND PAVEMENT MARKINGS INDICATED ON THIS DRAWING ARE CONSIDERED PART OF THE PERMIT AND SHALL BE INSTALLED AND MAINTAINED IN ACCORDANCE WITH PUBLICATION NO. 212.

POST MOUNTED SIGNALS SHALL BE INSTALLED WITH THE SIGNAL HEADS A MINIMUM OF 2 FEET BEHIND THE FACE OF CURB OR THE EDGE OF THE SHOULDER. SUPPORT POLES FOR OVERHEAD SIGNALS SHALL ALSO HAVE A MINIMUM CLEARANCE HORIZONTALLY OF 2 FEET.

SIGNALS ERECTED OVER THE ROADWAY SHALL HAVE A MINIMUM VERTICAL CLEARANCE OF 16 FT. ABOVE THE ROADWAY. POST MOUNTED SIGNALS SHALL BE A MINIMUM OF 8 FT. ABOVE THE SIDEWALK OR PAVEMENT.

ALL OVERHEAD SIGNALS MUST BE RIGIDLY MOUNTED, TOP AND BOTTOM, AND EQUIPPED WITH BACKPLATES.

THE MINIMUM HORIZONTAL DISTANCE BETWEEN SIGNALS MEASURED AT RIGHT ANGLES TO THE APPROACH SHALL BE 8 FEET.

EXACT LOCATION OF DETECTORS SHALL BE DETERMINED PRIOR TO INSTALLATION BY A REPRESENTATIVE OF PENNDOT.

CURBING TO BE INSTALLED BY MUNICIPALITY AND WHERE NOTED, SHALL BE PLAIN CEMENT CONCRETE OR CRANITE CURB, INSTALLED IN ACCORDANCE WITH DEPARTMENT SPECIFICATIONS FORM 40B.

PRIOR TO INSTALLATION THE CONTRACTOR SHALL CONSULT WITH THE LOCAL OFFICIALS AND UTILITY COMPANIES TO RESOLVE ANY PROBLEMS WHICH MAY BE CREATED DUE TO THE LOCATION OF UTILITIES.

THIS DRAWING CANNOT BE USED AS A CONSTRUCTION DRAWING UNLESS THE PERMITTEE COMPLIES WITH THE PROVISIONS OF THE LATEST AMENDMENT TO ACT 287, PREVENTION OF DAMAGE TO UNDERGROUND UTILITIES, DATED DECEMBER 20, 1974.

WHEN LIQUID FUELS MONEY IS USED, SIGNAL INSTALLATION MUST CONFORM TO FORM 40B AND A COPY OF THE PROPOSED SPECIFICATIONS MUST BE SUBMITTED TO THE DISTRICT TRAFFIC UNIT, FOR REVIEW, PRIOR TO BIDDING.

PERMITTEE SHALL BE OBTAIN A HIGHWAY OCCUPANCY PERMIT FOR ANY CHANGES IN INTERSECTION GEOMETRY REGARDING EXCAVATION.

CONDUIT INSTALLED IN BITUMINOUS ROADWAY LESS THAN 5 YEARS OLD, OR CONCRETE ROADWAY REGARDLESS OF AGE, MUST BE BORED OR JACKED UNDER THE ROADWAY. INSTALL IN ACCORDANCE WITH TRAFFIC SIGNAL STANDARDS TC-8800 SERIES.

SYSTEM PERMIT # I-0098

PENNSYLVANIA DEPARTMENT OF TRANSPORTATION
 ENGINEERING DISTRICT 6-0

COUNTY: MONTGOMERY
 MUNICIPALITY: HORSHAM & UPPER DUBLIN TWPS.
 INTERSECTION: WELSH ROAD (SR 0063)
 & JARRETTOWN ROAD/VILLAGE ROAD

REVIEWED: [Signature] 7/8/2015
 DATE

MUNICIPAL OFFICIAL DATE

RECOMMENDED: MARK L. KRAY 5-23-97
 DATE

MUNICIPAL SIGNALS ENGINEER DOUGLAS MAY 5-23-97
 DATE

DISTRICT TRAFFIC ENGINEER DATE

NO.	REVISION	REV.	DATE	REV.	DATE	RECOM.	DATE
1	NEW CADD DWG/TIMING UPDATE	CB	4/23/98	MK	4/23/98	DWM	4/28/98
2	CHANGE V/O TIMINGS	NU	4/29/00	MK	4/29/00	WJE	5/14/00
3	REV. COORD.	TPD	1/10/03	MK	1/30/03	LRB	2/1/03
4	ADD. NB RT LANE, EXP. TIMING IMPR. VIDEO DET. SURVISE	BURNS	6/17/15	DLA	7/4/15	ghat	7/15/15
5							
6							
7							
8							

SIGN TABULATION			
PLAN SYMBOL	SERIES	SIZE	DESCRIPTION
A	R9-3	18"x18"	NO PEDESTRIAN CROSSING SIGN
B	D3-4	72"x16"	Welsh Rd
C	R3-7R	30"x30"	RIGHT LANE MUST TURN RIGHT
D	R10-3E(L)	9"x15"	EDUCATIONAL PUSH BUTTON ←
E	OM1-3	18"x18"	OBJECT MARKER
F	R10-3E(R)	9"x15"	EDUCATIONAL PUSH BUTTON →
G	R10-12	30"x36"	LEFT TURN YIELD ON GREEN ●
H	R3-5A	30"x36"	STRAIGHT THROUGH SIGN
I	R3-5R	30"x36"	RIGHT TURN SIGN
J	R3-5L	30"x36"	LEFT TURN SIGN
K	W1-7	48"x24"	LARGE DOUBLE ARROW SIGN
L	D3-4	72"x16"	Dresher Rd
M	R10-10R	30"x36"	RIGHT TURN SIGNAL
N	R3-7L	30"x30"	LEFT LANE MUST TURN RIGHT

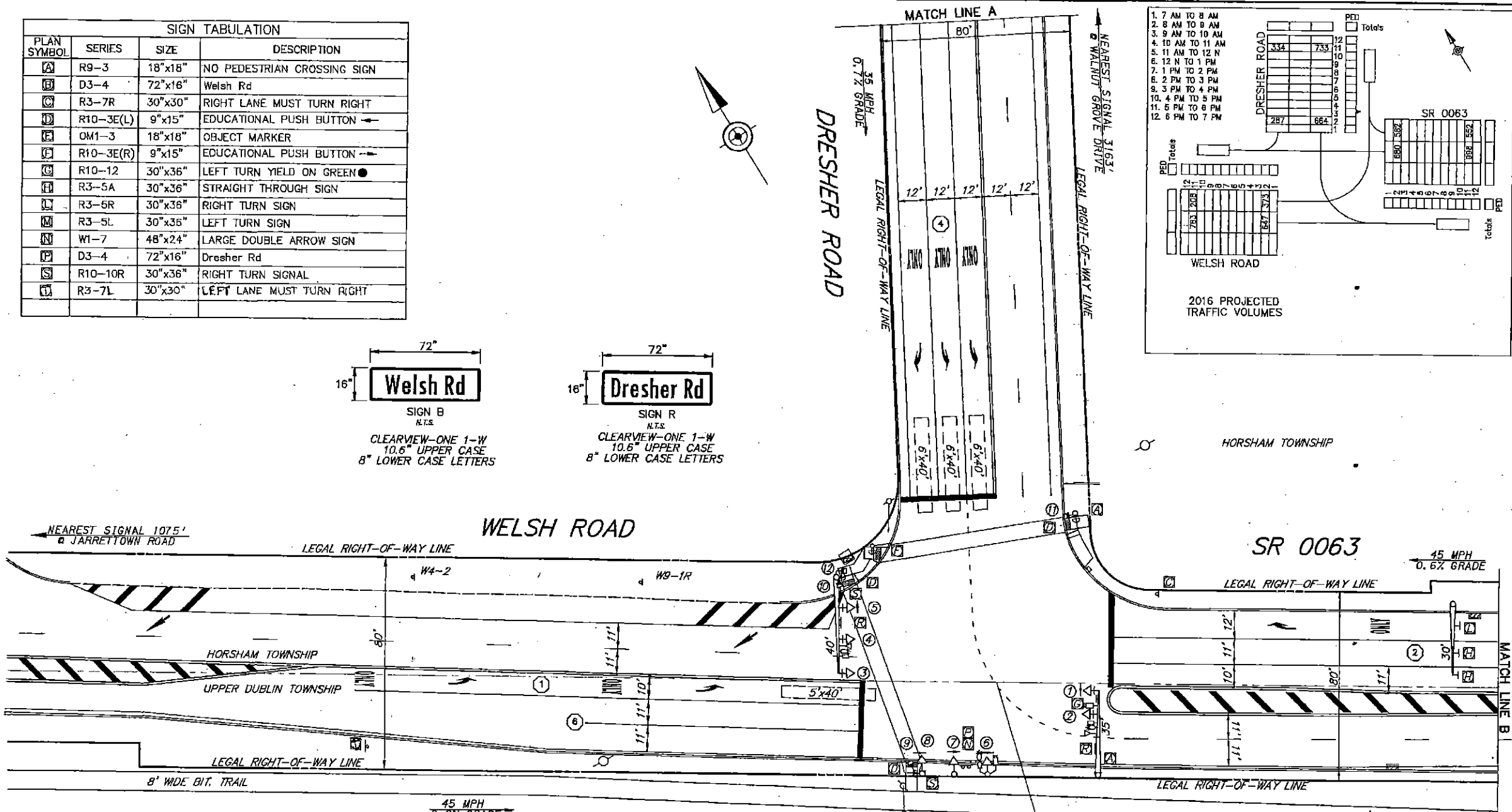
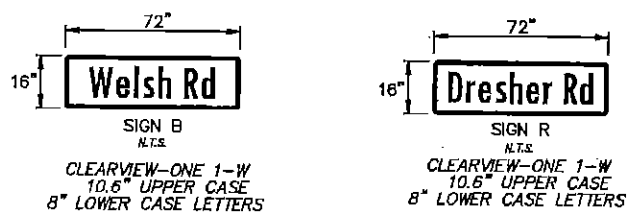

2016 PROJECTED TRAFFIC VOLUMES		Totals	
1. 7 AM TO 8 AM	334	12	12
2. 8 AM TO 8 AM	735	11	11
3. 9 AM TO 10 AM	110	10	10
4. 10 AM TO 11 AM	10	9	9
5. 11 AM TO 12 N	10	8	8
6. 12 N TO 1 PM	10	7	7
7. 1 PM TO 2 PM	10	6	6
8. 2 PM TO 3 PM	10	5	5
9. 3 PM TO 4 PM	10	4	4
10. 4 PM TO 5 PM	10	3	3
11. 5 PM TO 6 PM	10	2	2
12. 6 PM TO 7 PM	10	1	1

GENERAL NOTES

NO MODIFICATIONS OF THIS INSTALLATION ARE PERMITTED UNLESS PRIOR APPROVAL IS GRANTED IN WRITING BY A REPRESENTATIVE OF THE DEPARTMENT OF TRANSPORTATION.

ALL MAINTENANCE WORK INCLUDING TRIMMING OF TREES, NECESSARY FOR PROPER VISIBILITY OF THE SIGNALS IS THE RESPONSIBILITY OF THE PERMITTEE.

ALL SIGNS AND PAVEMENT MARKINGS INDICATED ON THIS DRAWING ARE CONSIDERED PART OF THE PERMIT AND SHALL BE INSTALLED AND MAINTAINED IN ACCORDANCE WITH PUBLICATION NO. 212.

POST MOUNTED SIGNALS SHALL BE INSTALLED WITH THE SIGNAL HEADS A MINIMUM OF 2 FEET BEHIND THE FACE OF CURB OR THE EDGE OF THE SHOULDER. SUPPORT POLES FOR OVERHEAD SIGNALS SHALL ALSO HAVE A MINIMUM CLEARANCE HORIZONTALLY OF 2 FEET.

SIGNALS ERECTED OVER THE ROADWAY SHALL HAVE A MINIMUM VERTICAL CLEARANCE OF 16 FT. ABOVE THE ROADWAY. POST MOUNTED SIGNALS SHALL BE A MINIMUM OF 8 FT. ABOVE THE SIDEWALK OR PAVEMENT.

ALL OVERHEAD SIGNALS MUST BE RIGIDLY MOUNTED, TOP AND BOTTOM, AND EQUIPPED WITH BACKPLATES.

THE MINIMUM HORIZONTAL DISTANCE BETWEEN SIGNALS MEASURED AT RIGHT ANGLES TO THE APPROACH SHALL BE 8 FEET.

EXACT LOCATION OF DETECTORS SHALL BE DETERMINED PRIOR TO INSTALLATION BY A REPRESENTATIVE OF PENNDOT.

CURBING TO BE INSTALLED BY MUNICIPALITY AND WHERE NOTED, SHALL BE PLAIN CEMENT CONCRETE OR GRANITE CURB, INSTALLED IN ACCORDANCE WITH DEPARTMENT SPECIFICATIONS FORM 408.

PRIOR TO INSTALLATION THE CONTRACTOR SHALL CONSULT WITH THE LOCAL OFFICIALS AND UTILITY COMPANIES TO RESOLVE ANY PROBLEMS WHICH MAY BE CREATED DUE TO THE LOCATION OF UTILITIES.

THIS DRAWING CANNOT BE USED AS A CONSTRUCTION DRAWING UNLESS THE PERMITTEE COMPLIES WITH THE PROVISIONS OF THE LATEST AMENDMENT TO ACT 287, PREVENTION OF DAMAGE TO UNDERGROUND UTILITIES, DATED DECEMBER 20, 1974.

WHEN LIQUID FUELS MONEY IS USED, SIGNAL INSTALLATION MUST CONFORM TO FORM 408 AND A COPY OF THE PROPOSED SPECIFICATIONS MUST BE SUBMITTED TO THE DISTRICT TRAFFIC UNIT, FOR REVIEW, PRIOR TO BIDDING.

PERMITTEE SHALL OBTAIN A HIGHWAY OCCUPANCY PERMIT FOR ANY CHANGES IN INTERSECTION GEOMETRY REGARDING EXCAVATION.

CONDUIT INSTALLED IN BITUMINOUS ROADWAY LESS THAN 5 YEARS OLD, OR CONCRETE ROADWAY REGARDLESS OF AGE, MUST BE BORED OR JACKED UNDER THE ROADWAY. INSTALL IN ACCORDANCE WITH TRAFFIC SIGNAL STANDARDS TC-8800 SERIES.

MOVEMENT, SEQUENCE, AND TIMING DIAGRAM

PHASE	1+6			2+6				4				FLASH
	INTERVAL	1	2	3	4	5	6	7	8	9	10	
1	1/2 G	Y	R	G	G	Y	R	R	R	R	R	Y
2	G	Y	R	G	G	Y	R	R	R	R	R	Y
3,4	R	R	R	G	G	Y	R	R	R	R	R	Y
5	R	R	R	G	G	Y	R	1/2 G	1/2 G	Y	R	OFF
6,7	R	R	R	R	R	R	R	1/2 G	1/2 G	Y	R	R
8	1/2 G	1/2 Y	R	R	R	R	R	G	G	Y	R	OFF
9,10	H	H	H	H	H	H	H	M	FH	H	H	OFF
11,12	H	H	H	M	FH	H	H	H	H	H	H	OFF

REFER TO SYSTEM PERMIT # I-0098 FOR PROGRAM TIMINGS AND WEEKLY PROGRAM CHARTS.

FIXED	4	2	4	2	4	3
MINIMUM	3		20		7	
PASSAGE	3		++		5	
MAX. 1	20		40		20	
PEDESTRIAN*			7	23	7	23
MEMORY	NL		MN		NL	

* UPON PEDESTRIAN ACTUATION ONLY

UPON PEDESTRIAN ACTUATION, OTHERWISE HAND SYMBOL AT ALL TIMES

OPERATION NOTES:

① G/Y IF FOLLOWED BY 2+6.

② G IF FOLLOWED BY 2+6.

++ ADVANCED DILEMMA ZONE DETECTION SYSTEM NOTES

EST. TIME OF ARRIVAL: MIN. 2.5-MAX. 5.5 SEC.

RANGE OF DETECTION: STOP BAR TO 450 FT.

SPEED BOUNDARY: MIN. 27-MAX. 100 MPH

DENSITY ZONE NOTES

RANGE OF DETECTION: STOP BAR TO 100 FT.

MINIMUM SPEED BOUNDARY: 5 MPH TO 30 MPH

SIGNAL INDICATIONS

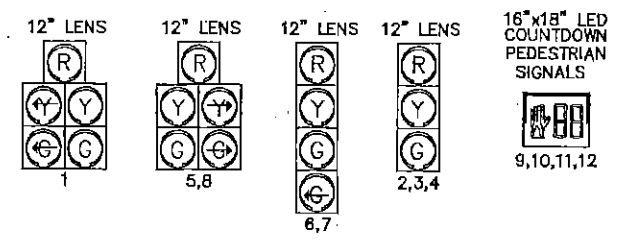

LEGEND

Symbol	Description	Symbol	Description
②	MAST ARM/IDENTIFYING LENGTH	②	DETECTION ZONE/SIZE
②	VEHICULAR SIGNAL HEAD/BACKPLATE/MSORS/DIRECTIONAL ARROW/IDENTIFYING NUMBER	②	PRE-EMPTION SYSTEM
②	PEDESTRIAN SIGNAL HEAD/IDENTIFYING NUMBER	②	FAIL-SAFE DEVICE
②	PEDESTRIAN PUSH-BUTTON/SIGN	②	CURB CUT RAMP
A	SIGN/IDENTIFYING LETTER	②	UTILITY POLE
		②	PHASE NUMBER
		②	VIDEO DETECTOR
		②	ADVANCE DILEMMA ZONE DETECTOR

SYSTEM PERMIT # I-0098

PENNSYLVANIA DEPARTMENT OF TRANSPORTATION
ENGINEERING DISTRICT 6-0

COUNTY: MONTGOMERY
MUNICIPALITY: HORSHAM & UPPER DUBLIN TWPS.
INTERSECTION: WELSH ROAD (SR 0063) & DRESHER ROAD

REVIEWED: *W. Lester* 7/8/2015 DATE

MUNICIPAL OFFICIAL: _____ DATE

RECOMMENDED: **JEFFREY GREENE** 7-6-81 DATE

MUNICIPAL SIGNALS ENGINEER: **STEPHEN B LESTER** 7-6-81 DATE

DISTRICT TRAFFIC ENGINEER: _____ DATE

NO.	REVISION	DES. REV.	DATE	REV.	DATE	REC'D	DATE
1	ADDING WB ORLT SIGN & PAVT MARKINGS	NV	9/11/00	RP	8/18/00	LRB	9/22/00
2	NEW DWG; REV COORD	TPD	1/10/05	MLK	1/20/05	LRB	2/1/05
3	ADD. EB L.T., EXP. TIMING IMPR., VIDEO DET.	BURNS	8/17/15	D.L.A.	7/24/15	W.L.	7/15/15
4							
5							
6							
7							
8							

EMERGENCY PRE-EMPTION
MOVEMENT, SEQUENCE, AND TIMING DIAGRAM

PHASE	6			2			4		
INTERVAL	12	13	14	15	16	17	18	19	20
1	Y	Y	R	R	R	R	R	R	R
2	G	Y	R	R	R	R	R	R	R
3,4	R	R	R	G	Y	R	R	R	R
5	R	R	R	G	Y	R	R	R	R
6,7	R	R	R	R	R	R	G	Y	R
8	R	R	R	R	R	R	G	Y	R
9,10	H	H	H	H	H	H	H	H	H
11,12	H	H	H	H	H	H	H	H	H

OPERATION NOTES:
 (a) SIGNAL TO INDICATE G WHEN RETURNING TO NORMAL OPERATION
 (b) SIGNAL TO INDICATE Y WHEN RETURNING TO NORMAL OPERATION

NOTE:
 IF PRE-EMPTION EQUIPMENT HAS ENCODING CAPABILITIES FOR VEHICLE IDENTIFICATION, IT IS RECOMMENDED TO HAVE THE ZERO "00" FEATURE ON, TO GIVE UNCODED EMITTERS THE ABILITY TO ACTIVATE THE EMERGENCY PRE-EMPTION.

EMERGENCY PRE-EMPTION NOTES:

- * CONTROLLER TO BE EQUIPPED WITH EMERGENCY PRE-EMPTION FOR THE SOUTHBOUND APPROACH OF DRESHER ROAD AND THE EASTBOUND AND WESTBOUND APPROACHES OF WELSH ROAD (SR 0063) WITH A FAIL SAFE DEVICE FOR EACH DIRECTION OF OPERATION.
- * THIS EMERGENCY BEACON SHALL CONSIST OF A FLASHING WHITE FLOOD LIGHT, AND SHALL FLASH WHEN THE EMERGENCY VEHICLE HAS CONTROL OF THE INTERSECTION FOR THE APPROPRIATE APPROACH. LOCATION OF THE EMERGENCY VEHICLE DETECTORS ARE TO BE FIELD ADJUSTED TO ACHIEVE MAXIMUM OPERATION.
- * THE SIGNALS, WHEN ACTIVATED BY EMERGENCY VEHICLES, SHALL TERMINATE ALL GREEN INDICATIONS IMMEDIATELY, FOLLOWED BY THE COMPLETE YELLOW AND RED CLEARANCE INTERVALS, ACCORDINGLY. THEN THE GREEN INTERVAL FOR THE PRE-EMPTED PHASE SHALL FOLLOW. ONLY THOSE PHASES NOT POSING A YELLOW TRAP CONDITION (PHASES 1+6, 6 AND 4) MAY REMAIN GREEN.
- * THE SIGNALS, WHEN ACTIVATED BY EMERGENCY VEHICLE SHALL TIME OUT ALL YELLOW, HAND/MAN AND RED INDICATIONS, FOLLOWED BY THE GREEN INTERVAL OF THE PRE-EMPTION PHASE GOVERNED BY THE APPROACHING EMERGENCY VEHICLE.
- * IF THE SIGNAL HAS BEEN ACTUATED BY PEDESTRIAN PUSHBUTTON, AND THE SIGNAL IS PRE-EMPTED DURING THE "MAN" INTERVAL, THE MAN INTERVAL SHALL TERMINATE IMMEDIATELY FOLLOWED BY THE "FLASHING HAND" INDICATION IN ITS ENTIRETY, FOLLOWED BY THE APPROPRIATE SELECTIVE CLEARANCES BEFORE PROCEEDING TO THE PRE-EMPTION PHASE.
- * IF THE SIGNALS, WHEN ACTIVATED BY AN EMERGENCY VEHICLE ARE FLASHING, ALL SIGNALS SHALL REMAIN FLASHING.
- * IF ADDITIONAL PRE-EMPTION PHASES ARE ACTIVATED WHILE IN PRE-EMPTION, THE ORIGINAL PRE-EMPTION PHASE SHALL TIME OUT BEFORE PROCEEDING TO THE NEXT PRE-EMPTION PHASE.
- * UPON COMPLETION OF PRE-EMPTION PHASES 2,4 OR 6 IN RETURNING TO NORMAL OPERATION, PHASE 2+6 INTERVAL 4 SHALL FOLLOW.
- * IN EMERGENCY PRE-EMPTION, NO PRIORITY SHALL BE ESTABLISHED. PRE-EMPTION SHALL BE A "FIRST COME, FIRST SERVE" OPERATION.

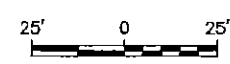
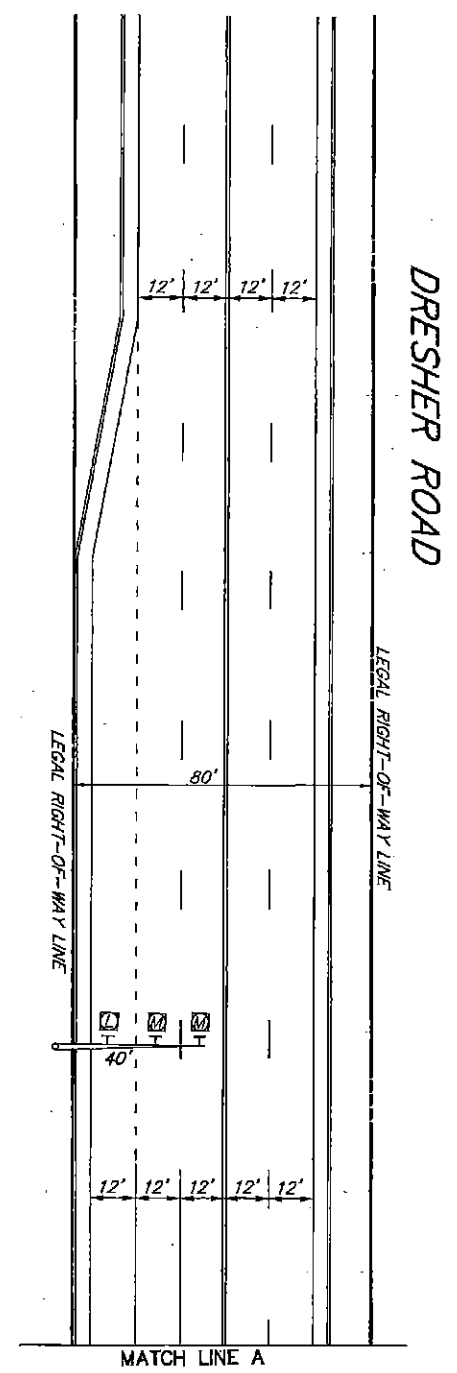
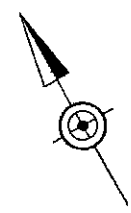
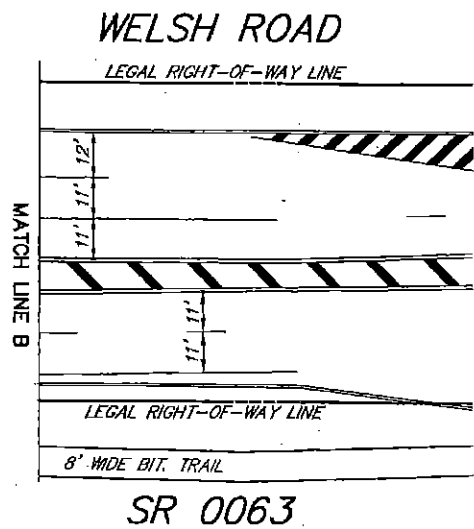

LEGEND

②	MAST ARM/IDENTIFYING LENGTH	②	DETECTION ZONE/SIZE
②	VEHICULAR SIGNAL HEAD/BACKPLATE/VISORS/DIRECTIONAL ARROW/IDENTIFYING NUMBER	②	PRE-EMPTION SYSTEM
②	PEDESTRIAN SIGNAL HEAD/IDENTIFYING NUMBER	②	FAIL-SAFE DEVICE
②	PEDESTRIAN PUSH-BUTTON/SIGN	②	CURB CUT RAMP
A	SIGN/IDENTIFYING LETTER	②	UTILITY POLE
		②	PHASE NUMBER
		②	VIDEO DETECTOR
		②	ADVANCE DILEMA ZONE DETECTOR

GENERAL NOTES

NO MODIFICATIONS OF THIS INSTALLATION ARE PERMITTED UNLESS PRIOR APPROVAL IS GRANTED IN WRITING BY A REPRESENTATIVE OF THE DEPARTMENT OF TRANSPORTATION.

ALL MAINTENANCE WORK INCLUDING TRIMMING OF TREES, NECESSARY FOR PROPER VISIBILITY OF THE SIGNALS IS THE RESPONSIBILITY OF THE PERMITTEE.

ALL SIGNS AND PAVEMENT MARKINGS INDICATED ON THIS DRAWING ARE CONSIDERED PART OF THE PERMIT AND SHALL BE INSTALLED AND MAINTAINED IN ACCORDANCE WITH PUBLICATION NO. 212.

POST MOUNTED SIGNALS SHALL BE INSTALLED WITH THE SIGNAL HEADS A MINIMUM OF 2 FEET BEHIND THE FACE OF CURB OR THE EDGE OF THE SHOULDER. SUPPORT POLES FOR OVERHEAD SIGNALS SHALL ALSO HAVE A MINIMUM CLEARANCE HORIZONTALLY OF 2 FEET.

SIGNALS ERECTED OVER THE ROADWAY SHALL HAVE A MINIMUM VERTICAL CLEARANCE OF 16 FT. ABOVE THE ROADWAY. POST MOUNTED SIGNALS SHALL BE A MINIMUM OF 8 FT. ABOVE THE SIDEWALK OR PAVEMENT.

ALL OVERHEAD SIGNALS MUST BE RIGIDLY MOUNTED, TOP AND BOTTOM, AND EQUIPPED WITH BACKPLATES.

THE MINIMUM HORIZONTAL DISTANCE BETWEEN SIGNALS MEASURED AT RIGHT ANGLES TO THE APPROACH SHALL BE 8 FEET.

EXACT LOCATION OF DETECTORS SHALL BE DETERMINED PRIOR TO INSTALLATION BY A REPRESENTATIVE OF PENNDOT.

CURBING TO BE INSTALLED BY MUNICIPALITY AND WHERE NOTED, SHALL BE PLAIN CEMENT CONCRETE OR GRANITE CURB, INSTALLED IN ACCORDANCE WITH DEPARTMENT SPECIFICATIONS FORM 408.

PRIOR TO INSTALLATION THE CONTRACTOR SHALL CONSULT WITH THE LOCAL OFFICIALS AND UTILITY COMPANIES TO RESOLVE ANY PROBLEMS WHICH MAY BE CREATED DUE TO THE LOCATION OF UTILITIES.

THIS DRAWING CANNOT BE USED AS A CONSTRUCTION DRAWING UNLESS THE PERMITTEE COMPLIES WITH THE PROVISIONS OF THE LATEST AMENDMENT TO ACT 287, PREVENTION OF DAMAGE TO UNDERGROUND UTILITIES, DATED DECEMBER 20, 1974.

WHEN LIQUID FUELS MONEY IS USED, SIGNAL INSTALLATION MUST CONFORM TO FORM 408 AND A COPY OF THE PROPOSED SPECIFICATIONS MUST BE SUBMITTED TO THE DISTRICT TRAFFIC UNIT, FOR REVIEW, PRIOR TO BIDDING.

PERMITTEE SHALL OBTAIN A HIGHWAY OCCUPANCY PERMIT FOR ANY CHANGES IN INTERSECTION GEOMETRY REGARDING EXCAVATION.

CONDUIT INSTALLED IN BITUMINOUS ROADWAY LESS THAN 5 YEARS OLD, OR CONCRETE ROADWAY REGARDLESS OF AGE, MUST BE BORED OR JACKED UNDER THE ROADWAY. INSTALL IN ACCORDANCE WITH TRAFFIC SIGNAL STANDARDS TC-8800 SERIES.

SYSTEM PERMIT # I-0098

PENNSYLVANIA DEPARTMENT OF TRANSPORTATION
ENGINEERING DISTRICT 6-0

COUNTY: MONTGOMERY
 MUNICIPALITY: HORSHAM & UPPER DUBLIN TWP.
 INTERSECTION: WELSH ROAD (SR 0063) & DRESHER ROAD

REVIEWED: *W. J. New* 7/8/2015 DATE

MUNICIPAL OFFICIAL: _____ DATE
 RECOMMENDED: JEFFREY GREENE 7-6-81 DATE
 MUNICIPAL SIGNALS ENGINEER: STEPHEN B LESTER 7-6-81 DATE
 DISTRICT TRAFFIC ENGINEER: _____ DATE

NO.	REVISION	DES. REV.	DATE	REV. DATE	RECOM. DATE
1	ADDING THE CHLC SIGN & PWT MARKINGS	NV	9/11/00	RP 9/18/00	LRB 9/22/00
2	NEW DWG; REV COORD	TPD	1/10/05	MLK 1/20/05	LRB 2/1/05
3	ADD. EB LTL, EPT, TIMING IMPR., VIDEO DET. BURNS	BURNS	6/17/05	DLA 7/1/05	LRB 7/15/05
4					
5					
6					
7					
8					

SIGN TABULATION			
PLAN SYMBOL	SERIES NUMBER	SIZE	REMARKS
A	R9-3	18"x18"	NO PEDESTRIAN CROSSING
B	R3-5L	30"x36"	LEFT TURN
C	R3-5R	30"x36"	RIGHT TURN
D	R3-7L	30"x30"	LEFT LANE MUST TURN LEFT
E	W1-7	48"x24"	LARGE DOUBLE ARROW
F	R10-12	30"x36"	LEFT TURN YIELD ON GREEN
G	D3-4	72"x16"	Welsh Rd
H	D3-4	96"x16"	Dreshertown Rd
I	R10-10R	24"x30"	RIGHT TURN SIGNAL
J	R10-10L	24"x30"	LEFT TURN SIGNAL
K	R10-3E	9"x15"	EDUCATIONAL PUSH BUTTON
L	R10-3E	9"x15"	EDUCATIONAL PUSH BUTTON
M	R10-11	30"x36"	NO TURN ON RED
N	R3-7R	30"x30"	RIGHT LANE MUST TURN RIGHT

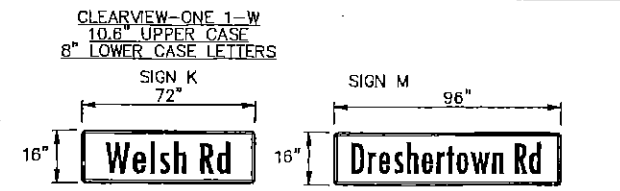

EMERGENCY PRE-EMPTION PHASING MOVEMENT, SEQUENCE AND TIMING DIAGRAM

PHASE	2	6	8
1	R R R	Y G R	R R R
2	R R R	Y G R	R R R
3,4,5	G Y R	R R R	R R R
6	R R R	R R R	G Y R
7,8	R R R	R R R	G Y R
9	R R R	R R R	G Y R
10,11	H H H	H H H	H H H
12,13	H H H	H H H	H H H
FIXED	* 5 2	* 5 2	* 4 2

* FOR DURATION OF PRE-EMPTION
 (G) G/Y WHEN RETURNING TO NORMAL OPERATION.
 (R) G WHEN RETURNING TO NORMAL OPERATION.

NOTE:
 IF PRE-EMPTION EQUIPMENT HAS ENCODING CAPABILITIES FOR VEHICLE IDENTIFICATION, IT IS RECOMMENDED TO HAVE THE ZERO "00" FEATURE ON TO GIVE UNCODED EMITTERS THE ABILITY TO ACTIVATE THE EMERGENCY PRE-EMPTION.

EMERGENCY PRE-EMPTION NOTES:

- CONTROLLER TO BE EQUIPPED WITH EMERGENCY PRE-EMPTION FOR THE EASTBOUND & WESTBOUND APPROACHES OF WELSH ROAD AND THE NORTHBOUND APPROACH OF DRESHERTOWN ROAD WITH A FAIL SAFE DEVICE FOR EACH DIRECTION OF OPERATION.
- THIS EMERGENCY BEACON SHALL CONSIST OF A FLASHING WHITE FLOOD LIGHT, AND SHALL FLASH WHEN THE EMERGENCY VEHICLE HAS CONTROL OF THE INTERSECTION FOR THE APPROPRIATE APPROACH.
- THE SIGNALS, WHEN ACTIVATED BY EMERGENCY VEHICLE, SHALL TERMINATE ALL INDICATIONS, FOLLOWED BY SELECTIVE CLEARANCES DEPENDENT UPON THE PHASE IN WHICH THE PRE-EMPTION OCCURS. THE "GREEN" INDICATIONS FOR THE PRE-EMPTED PHASE SHALL REMAIN "GREEN" FOR THE DURATION OF SIGNAL PRE-EMPTION AND "RED" INDICATIONS DISPLAYED FOR ALL OTHER PHASES. ONLY THOSE PHASES NOT POSING A YELLOW TRAP CONDITION (PHASES 1+6 AND 8) MAY REMAIN GREEN.
- THE SIGNALS, WHEN ACTIVATED BY EMERGENCY VEHICLE SHALL TIME OUT ALL YELLOW AND RED INDICATIONS, FOLLOWED BY THE GREEN INTERVAL OF THE PRE-EMPTION PHASE GOVERNED BY THE APPROACHING EMERGENCY VEHICLE.
- IF THE SIGNAL HAS BEEN ACTIVATED BY A PEDESTRIAN PUSH BUTTON AND THE SIGNAL IS PRE-EMPTED THE PEDESTRIAN TIME SHALL BE SPLIT BETWEEN "PED WALK" AND "PED CLEAR". THE "PED WALK" INTERVAL SHALL TERMINATE IMMEDIATELY FOLLOWED BY THE "PED CLEAR" INTERVAL. THIS INTERVAL SHALL TIME OUT FOLLOWED BY THE APPROPRIATE SELECTIVE CLEARANCES BEFORE PROCEEDING TO THE PRE-EMPTION PHASE.
- IF THE SIGNALS, WHEN ACTIVATED BY AN EMERGENCY VEHICLE, ARE FLASHING ALL SIGNALS SHALL REMAIN FLASHING.
- IF ADDITIONAL PRE-EMPTION PHASES ARE ACTIVATED WHILE IN PRE-EMPTION, THE ORIGINAL PRE-EMPTION PHASE SHALL TIME OUT BEFORE PROCEEDING TO THE NEXT PRE-EMPTION PHASE.
- UPON COMPLETION OF PRE-EMPTION, PHASE 2, 6, OR 8 IN RETURNING TO NORMAL OPERATION, PHASE 2+6 INTERVAL 4 SHALL FOLLOW.
- IN EMERGENCY PRE-EMPTION, NO PRIORITY SHALL BE ESTABLISHED, PRE-EMPTION SHALL BE A "FIRST COME, FIRST SERVE" OPERATION.

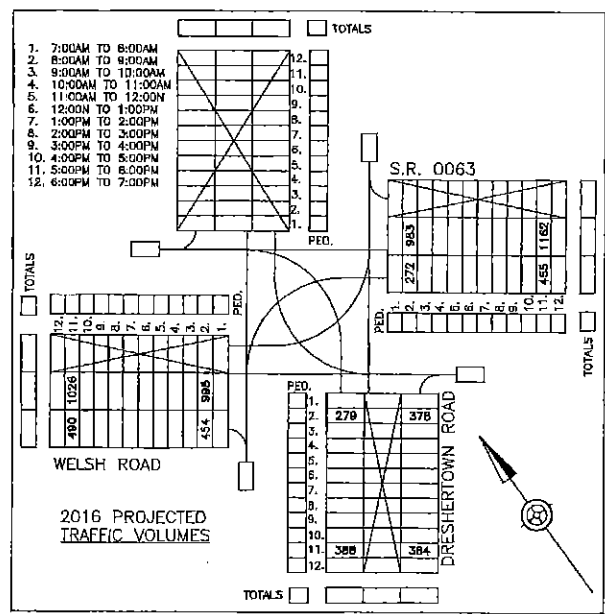

GENERAL NOTES

- NO MODIFICATIONS OF THIS INSTALLATION ARE PERMITTED UNLESS PRIOR APPROVAL IS GRANTED IN WRITING BY A REPRESENTATIVE OF THE DEPARTMENT OF TRANSPORTATION.
- ALL MAINTENANCE WORK INCLUDING TRIMMING OF TREES, NECESSARY FOR PROPER VISIBILITY OF THE SIGNALS IS THE RESPONSIBILITY OF THE PERMITTEE.
- ALL SIGNS AND PAVEMENT MARKINGS INDICATED ON THIS DRAWING ARE CONSIDERED PART OF THE PERMIT AND SHALL BE INSTALLED AND MAINTAINED IN ACCORDANCE WITH PUBLICATION NO. 212.
- POST MOUNTED SIGNALS SHALL BE INSTALLED WITH THE SIGNAL HEADS A MINIMUM OF 2 FEET BEHIND THE FACE OF CURB OR THE EDGE OF THE SHOULDER. SUPPORT POLES FOR OVERHEAD SIGNALS SHALL ALSO HAVE A MINIMUM CLEARANCE HORIZONTALLY OF 2 FEET.
- SIGNALS ERECTED OVER THE ROADWAY SHALL HAVE A MINIMUM VERTICAL CLEARANCE OF 16 FT. ABOVE THE ROADWAY. POST MOUNTED SIGNALS SHALL BE A MINIMUM OF 8 FT. ABOVE THE SIDEWALK OR PAVEMENT.
- ALL OVERHEAD SIGNALS MUST BE RIGIDLY MOUNTED, TOP AND BOTTOM, AND EQUIPPED WITH BACKPLATES.
- THE MINIMUM HORIZONTAL DISTANCE BETWEEN SIGNALS MEASURED AT RIGHT ANGLES TO THE APPROACH SHALL BE 8 FEET.
- EXACT LOCATION OF DETECTORS SHALL BE DETERMINED PRIOR TO INSTALLATION BY A REPRESENTATIVE OF PENNDOT.
- CURBING TO BE INSTALLED BY MUNICIPALITY AND WHERE NOTED, SHALL BE PLAN CEMENT CONCRETE CURB OR GRANITE CURB, INSTALLED IN ACCORDANCE WITH DEPARTMENT SPECIFICATIONS FORM 408.
- PRIOR TO INSTALLATION THE CONTRACTOR SHALL CONSULT WITH THE LOCAL OFFICIALS AND UTILITY COMPANIES TO RESOLVE ANY PROBLEMS WHICH MAY BE CREATED DUE TO THE LOCATION OF UTILITIES.
- THIS DRAWING CANNOT BE USED AS A CONSTRUCTION DRAWING UNLESS THE PERMITTEE COMPLIES WITH THE PROVISIONS OF THE LATEST AMENDMENT TO ACT 287, PREVENTION OF DAMAGE TO UNDERGROUND UTILITIES, EFFECTIVE DATE DECEMBER 20, 1974.
- WHEN LIQUID FUELS MONEY IS USED, SIGNAL INSTALLATION MUST CONFORM TO FORM 408 AND A COPY OF THE PROPOSED SPECIFICATIONS MUST BE SUBMITTED TO THE DISTRICT TRAFFIC UNIT FOR REVIEW PRIOR TO BIDDING.
- PERMITTEE SHALL OBTAIN A HIGHWAY OCCUPANCY PERMIT FOR ANY CHANGES IN INTERSECTION GEOMETRY REGARDING EXCAVATION.
- CONDUIT INSTALLED IN BITUMINOUS ROADWAY LESS THAN 5 YEARS OLD, OR CONCRETE ROADWAY REGARDLESS OF AGE, MUST BE BORED OR JACKED UNDER THE ROADWAY. INSTALL IN ACCORDANCE WITH TRAFFIC SIGNAL STANDARDS TO-8600 SERIES.

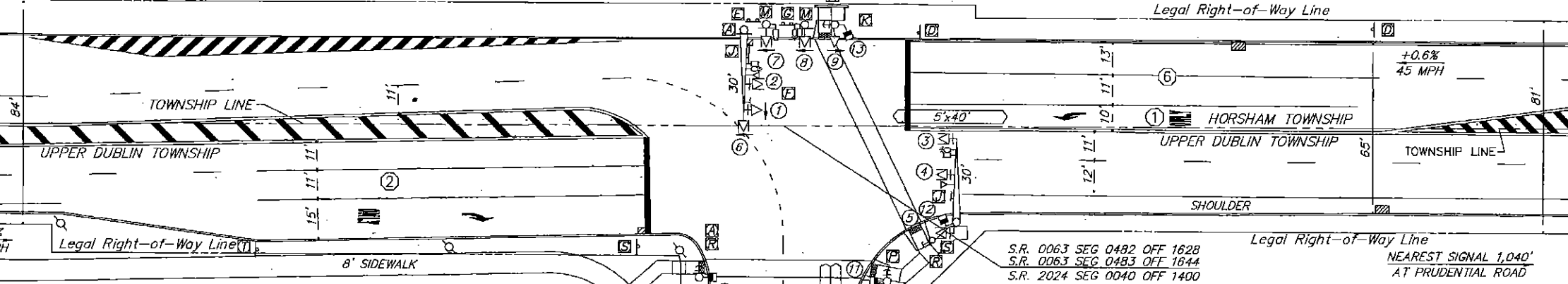

MOVEMENT, SEQUENCE AND TIMING DIAGRAM

PHASE	1+6	2+6	8
1	G Y R	G G Y R R R R R R Y	R R R
2	G Y R	G G Y R R R R R R Y	R R R
3,4,5	R R R	G G Y R R R R R R Y	R R R
6	R R R	R R R R R R R R R Y	G Y R
7,8	R R R	R R R R R R R R R Y	G Y R
9	R R R	R R R R R R R R R Y	G Y R
10,11	H H H	M F H H H H H H H OFF	H H H
12,13	H H H	H H H H H H H H H OFF	H H H

OPERATION NOTES:
 (1) G/Y IF FOLLOWED BY 2+6
 (2) G IF FOLLOWED BY 2+6
 (3) G IF FOLLOWED BY 2+6

FIXED	5	2	5	2	4	3
MINIMUM	3		20		7	
PASSAGE	3		++		5	
MAX. 1	20		40		20	

* UPON PEDESTRIAN ACTUATION, OTHERWISE HAND SYMBOL AT ALL TIMES

++ ADVANCED DILEMMA ZONE DETECTION SYSTEM NOTES
 EST. TIME OF ARRIVAL: MIN. 2.5-MAX. 5.5 SEC.
 RANGE OF DETECTION: STOP BAR TO 450 FT.
 SPEED BOUNDARY: MIN. 27-MAX. 100 MPH

DENSITY ZONE NOTES
 RANGE OF DETECTION: STOP BAR TO 100 FT.
 MINIMUM SPEED BOUNDARY: 5 MPH TO 30 MPH

SIGNAL INDICATIONS

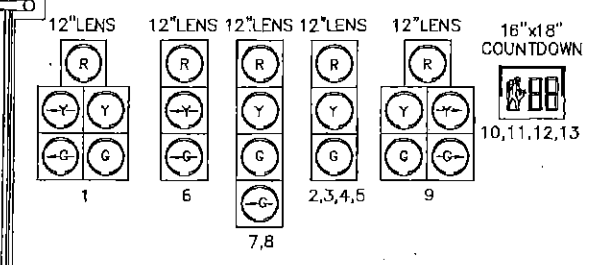

SIGNALS TO BE EQUIPPED WITH TUNNEL VISORS 2,3,4,5,6,7,8
 SIGNALS TO BE EQUIPPED WITH TUNNEL VISORS & LOUVERS

LEGEND

- MAST ARM/IDENTIFYING LENGTH (12x6)
- VEHICULAR SIGNAL HEAD/BACKPLATE/VISORS/DIRECTIONAL ARROW/IDENTIFYING NUMBER
- PEDESTRIAN SIGNAL HEAD/IDENTIFYING NUMBER
- PEDESTRIAN PUSH-BUTTON/SIGN
- SIGN/IDENTIFYING LETTER
- LOOP SENSOR/SIZE
- PRE-EMPTION SYSTEM
- FAIL-SAFE DEVICE
- CURB CUT RAMP
- UTILITY POLE
- PHASE NUMBER
- ADVANCE DILEMMA ZONE DETECTOR

SYSTEM PERMIT # I-0098

PENNSYLVANIA DEPARTMENT OF TRANSPORTATION
 ENGINEERING DISTRICT 6-0

COUNTY: MONTGOMERY
 MUNICIPALITY: UPPER DUBLIN/HORSHAM TWPS.
 INTERSECTION: WELSH ROAD (S.R. 0063) AND DRESHERTOWN ROAD (S.R. 2024)

REVIEWED: [Signature] 7/1/2015
 DATE: 7/1/2015

MUNICIPAL OFFICIAL: [Signature] DATE: 5/30/96
 RECOMMENDED: MARK KRAY SIGNALS ENGINEER DATE: 5/30/96
 DOUGLAS W. MAY, PE DISTRICT TRAFFIC ENGINEER DATE: 5/30/96

NO.	REVISION	DES/REV.	DATE	REV.	DATE	RECOM.	DATE
1	NEW GEOMETRY						
2	RE-LOCATED M.A. POLES	NV	9/00	MLK	9/00	LRB	9/00
3	CHNG MA FOR OHLG DRSHRTWN RD	MGM	10/01	MLK	11/2/01	LRB	11/15/01
4	REV. COORD.	TPD	1/10/05	MLK	1/20/05	LRB	2/1/05
5	ADD EB RGT TURN LN. DILEMMA DET. D.TOWN APPR RESTRIPE, TIMING CHNGS	BURNS	6/17/15	DWA	7/1/15	apw	7/15/15
6							
7							
8							

SHEET 2 OF 2 PERMIT # 64-1893 FILE # 1893

WELSH ROAD BUSINESS CENTER

Time	WELSH ROAD	DRYDEN ROAD	Totals
8 AM - 9 AM	107	88	195
9 AM - 10 AM	107	88	195
10 AM - 11 AM	107	88	195
11 AM - 12 PM	107	88	195
12 PM - 1 PM	107	88	195
1 PM - 2 PM	107	88	195
2 PM - 3 PM	107	88	195
3 PM - 4 PM	107	88	195
4 PM - 5 PM	107	88	195
5 PM - 6 PM	107	88	195
6 PM - 7 PM	107	88	195
Totals	1070	880	1950

4 PROJECTED TRAFFIC VOLUMES SATURDAY

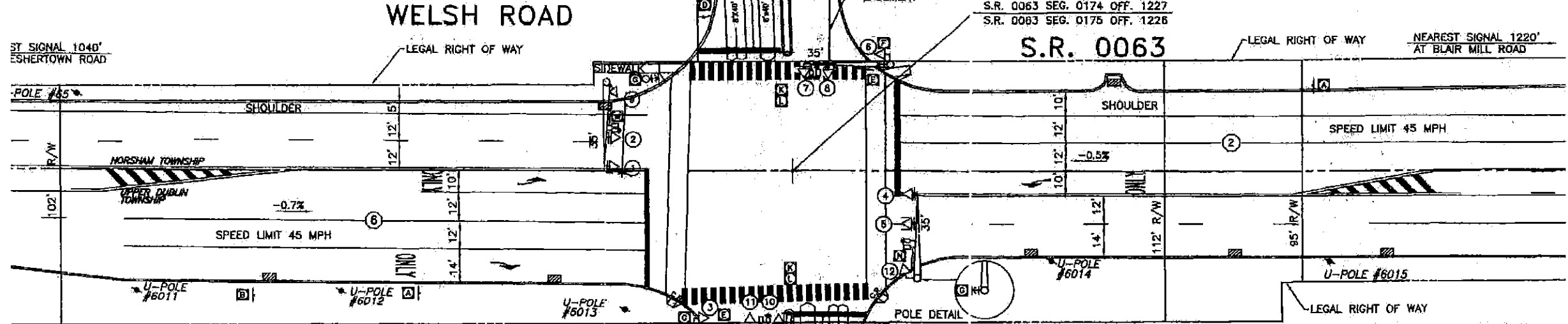

SIGN TABULATION

PLAN SYMBOL	SERIES NUMBER	SIZE	REMARKS
A	R3-7L	30X30	LEFT LANE MUST TURN LEFT
B	R3-7R	30X30	RIGHT LANE MUST TURN RIGHT
C	R3-8(L-SR)	30X30	LANE USE CONTROL
D	D3-4	78X16	Welsh Rd
E	R10-3(R)	9X12	PUSH BUTTON FOR GREEN LIGHT
F	R10-3(L)	9X12	PUSH BUTTON FOR GREEN LIGHT
G	R4-7	24X30	KEEP RIGHT
H	W16-1	18X18	HAZARD MARKER
I	D3-4	78X16	Dryden Rd
J	D3-4	78X16	Dryden Rd

#3215 GENERAL NOTES

NO MODIFICATIONS OF THIS INSTALLATION ARE PERMITTED UNLESS PRIOR APPROVAL IS GRANTED IN WRITING BY A REPRESENTATIVE OF THE DEPARTMENT OF TRANSPORTATION.

ALL MAINTENANCE WORK INCLUDING TRIMMING OF TREES, NECESSARY FOR PROPER VISIBILITY OF THE SIGNALS IS THE RESPONSIBILITY OF THE PERMITTEE.

ALL SIGNS AND PAVEMENT MARKINGS INDICATED ON THIS DRAWING ARE CONSIDERED PART OF THE PERMIT AND SHALL BE INSTALLED AND MAINTAINED IN ACCORDANCE WITH PUBLICATION NO. 68.

POST MOUNTED SIGNALS SHALL BE INSTALLED WITH THE SIGNAL HEADS A MINIMUM OF 2 FEET BEHIND THE FACE OF CURB OR THE EDGE OF THE SHOULDER. SUPPORT POLES FOR OVERHEAD SIGNALS SHALL ALSO HAVE A MINIMUM CLEARANCE HORIZONTALLY OF 2 FEET.

SIGNALS ERECTED OVER THE ROADWAY SHALL HAVE A MINIMUM VERTICAL CLEARANCE OF 16 FT. ABOVE THE ROADWAY. POST MOUNTED SIGNALS SHALL BE A MINIMUM OF 8 FT. ABOVE THE SIDEWALK OR PAVEMENT.

ALL OVERHEAD SIGNALS MUST BE RIGIDLY MOUNTED, TOP AND BOTTOM, AND EQUIPPED WITH BACKPLATES.

THE MINIMUM HORIZONTAL DISTANCE BETWEEN SIGNALS MEASURED AT RIGHT ANGLES TO THE APPROACH SHALL BE 8 FEET.

EXACT LOCATION OF DETECTORS SHALL BE DETERMINED PRIOR TO INSTALLATION BY A REPRESENTATIVE OF PENNDOT.

CURBING TO BE INSTALLED BY MUNICIPALITY AND WHERE NOTED, SHALL BE PLAIN CEMENT CONCRETE CURB OR GRANITE CURB, INSTALLED IN ACCORDANCE WITH DEPARTMENT SPECIFICATIONS FORM 408.

PRIOR TO INSTALLATION THE CONTRACTOR SHALL CONSULT WITH THE LOCAL OFFICIALS AND UTILITY COMPANIES TO RESOLVE ANY PROBLEMS WHICH MAY BE CREATED DUE TO THE LOCATION OF UTILITIES.

THIS DRAWING CANNOT BE USED AS A CONSTRUCTION DRAWING UNLESS THE PERMITTEE COMPLIES WITH THE PROVISIONS OF ACT 187, PREVENTION OF DAMAGE TO UNDERGROUND UTILITIES, EFFECTIVE DATE DECEMBER 18, 1986.

WHEN LIQUID FUELS MONEY IS USED, SIGNAL INSTALLATION MUST CONFORM TO FORM 408 AND A COPY OF THE PROPOSED SPECIFICATIONS MUST BE SUBMITTED TO THE DISTRICT TRAFFIC UNIT, FOR REVIEW, PRIOR TO BIDDING.

PERMITTEE SHALL OBTAIN A HIGHWAY OCCUPANCY PERMIT FOR ANY CHANGES IN INTERSECTION GEOMETRY REGARDING EXCAVATION.

CONDUIT INSTALLED IN BITUMINOUS ROADWAY LESS THAN 5 YEARS OLD, OR CONCRETE ROADWAY REGARDLESS OF AGE, MUST BE BORED OR JACKED UNDER THE ROADWAY. INSTALL IN ACCORDANCE WITH TRAFFIC SIGNAL STANDARDS 10-7800 SERIES.

MOVEMENT, SEQUENCE AND TIMING DIAGRAM

PHASE	2+6			4+8			FLASH
	1	2	3	4	5	6	
1,2	G	Y	R	R	R	R	Y
3	G	Y	R	R	R	R	OFF
4,5	G	Y	R	R	R	R	Y
6	G	Y	R	R	R	R	OFF
7,8	R	R	R	G	Y	R	R
9	R	R	R	G	Y	R	OFF
10,11	R	R	R	G	Y	R	R
12	R	R	R	R	R	R	OFF

FIXED	4	2	3	3
MINIMUM	21		5	
PASSAGE			3	
MAX. 1	45		25	
PEDESTRIAN*			25	
MEMORY	NX		NL 3 3	

NOTE: REFER TO INTERCONNECT PERMIT #10098 FOR PROGRAM TIMINGS & WEEKLY PROGRAM CHART.

* UPON PEDESTRIAN ACTUATION ONLY.

* MINIMUM GREEN TIME, ACTUAL GREEN TIME TO BE DETERMINED BY CONTROLLER AND TBC.

* SIGNAL TO DWELL IN PHASE 2+6 UNTIL ACTUATED BY PHASE 4+8

EMERGENCY PRE-EMPTION NOTES:

- CONTROLLER TO BE EQUIPPED WITH EMERGENCY PRE-EMPTION FOR THE NORTHBOUND OF DRYDEN ROAD AND THE SOUTHBOUND APPROACH OF WELSH ROAD BUSINESS CENTER AND THE EASTBOUND AND WESTBOUND APPROACHES OF WELSH ROAD (SR 0063) WITH A FAIL SAFE DEVICE FOR EACH DIRECTION OF OPERATION. THIS EMERGENCY BEACON SHALL CONSIST OF A FLASHING WHITE FLOOD LIGHT, AND SHALL FLASH WHEN THE EMERGENCY VEHICLE HAS CONTROL OF THE INTERSECTION FOR THE APPROPRIATE APPROACH.
- THE SIGNALS, WHEN ACTIVATED BY EMERGENCY VEHICLE, SHALL TERMINATE ALL GREEN INDICATIONS IMMEDIATELY, FOLLOWED BY THE COMPLETE YELLOW AND RED CLEARANCE INTERVALS, ACCORDINGLY. THEN THE GREEN INTERVAL FOR THE PRE-EMPTION PHASES SHALL FOLLOW.
- THE SIGNALS, WHEN ACTIVATED BY EMERGENCY VEHICLE SHALL TIME OUT ALL YELLOW AND RED INDICATIONS, FOLLOWED BY THE GREEN INTERVAL OF THE PRE-EMPTION PHASES GOVERNED BY THE APPROACHING EMERGENCY VEHICLE.
- IF THE SIGNAL HAS BEEN ACTUATED BY A PEDESTRIAN PUSH BUTTON AND THE SIGNAL IS PRE-EMPTED THE PEDESTRIAN TIME SHALL BE SPLIT BETWEEN "PED WALK" AND "PED CLEAR". THE "PED WALK" INTERVAL SHALL TERMINATE IMMEDIATELY FOLLOWED BY THE "PED CLEAR" INTERVAL. THIS INTERVAL SHALL TIME OUT FOLLOWED BY THE APPROPRIATE SELECTIVE CLEARANCES BEFORE PROCEEDING TO THE PRE-EMPTION PHASE.
- IF THE SIGNALS, WHEN ACTIVATED BY AN EMERGENCY VEHICLE, ARE FLASHING ALL SIGNALS SHALL REMAIN FLASHING.
- IF ADDITIONAL PRE-EMPTION PHASES ARE ACTIVATED WHILE IN PRE-EMPTION, THE ORIGINAL PRE-EMPTION PHASE SHALL TIME OUT BEFORE PROCEEDING TO THE NEXT PRE-EMPTION PHASE.
- UPON COMPLETION OF PRE-EMPTION PHASE 2, 4, 6 OR 8 IN RETURNING TO NORMAL OPERATION, PHASE 2+6 INTERVAL 1 SHALL FOLLOW.
- IN EMERGENCY PRE-EMPTION, NO PRIORITY SHALL BE ESTABLISHED, PRE-EMPTION SHALL BE A "FIRST COME, FIRST SERVED" OPERATION.
- LOCATION OF EMERGENCY VEHICLE DETECTORS ARE TO BE FIELD ADJUSTED TO ACHIEVE MAXIMUM OPERATION.

EMERGENCY PRE-EMPTION PHASING

MOVEMENT, SEQUENCE AND TIMING DIAGRAM

PHASE	2			4			6			8		
	7	8	9	10	11	12	13	14	15	16	17	18
1,2	O	Y	R	R	R	R	R	R	R	R	R	R
3	R	R	R	R	R	R	R	R	R	R	R	R
4,5	R	R	R	R	R	R	G	Y	R	R	R	R
6	R	R	R	R	R	R	R	R	R	R	R	R
7,8	R	R	R	O	Y	R	R	R	R	R	R	R
9	R	R	R	R	R	R	R	R	R	R	R	R
10,11	R	R	R	R	R	R	R	R	R	R	R	R
12	R	R	R	R	R	R	R	R	R	R	R	R

LEGEND

- ② MAST ARM/IDENTIFYING LENGTH
- ④ VEHICULAR SIGNAL HEAD/BACKPLATE/SENSOR/DIRECTIONAL ARROW/IDENTIFYING NUMBER
- ⑥ PEDESTRIAN SIGNAL HEAD/IDENTIFYING NUMBER
- ⑧ PEDESTRIAN PUSHBUTTON/SIGN
- ⑩ SIGN/IDENTIFYING LETTER
- ⑫ LOOP SENSOR/SIZE
- ⑭ MICROWAVE PRESENCE DETECTOR
- ⑮ EMERGENCY PRE-EMPTION FLASHING BEACON
- ⑯ EMERGENCY PRE-EMPTION DEVICE
- ⑰ CURB RAMP
- ⑱ UTILITY POLE
- ⑳ PHASE NUMBER
- ㉑ INLET

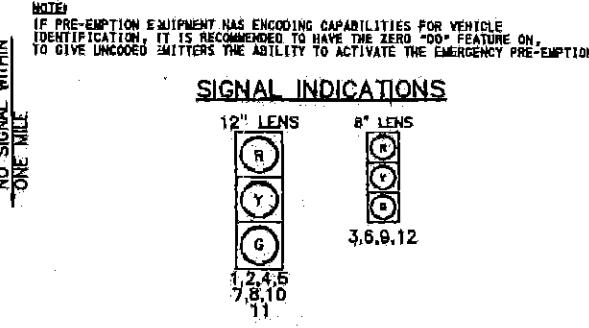

SCALE IN FEET: 25' 0' 25' 50'

SYSTEM PERMIT # 10098

PENNSYLVANIA DEPARTMENT OF TRANSPORTATION
ENGINEERING DISTRICT 6-0

COUNTY: MONTGOMERY

MUNICIPALITY: UPPER DUBLIN/HORSHAM TWP.

INTERSECTION: WELSH ROAD (S.R. 0063) AND DRYDEN ROAD/WELSH RD BUSINESS CTR

REVIEWED: _____ DATE _____

MUNICIPAL OFFICIAL: _____ DATE _____

RECOMMENDED: MARK L. KRAY 9/18/00

DISTRICT TRAFFIC ENGINEER: L. R. BELMONTE 9/22/00

NO.	REVISION	DATE	BY	DATE	BY
1	REVISED COORDINATION	8/19/00	MCM	11/22/00	MLC
2	REV. BUSINESS CTR ACCESS DESIGN	8/19/00	MCM	11/22/00	MLC
3	REV COORD.	11/24/00	MLC	1/20/01	MLC
4					
5					
6					
7					
8					

SHEET 2 OF 2 PERMIT # 64-3215 FILE # 3215

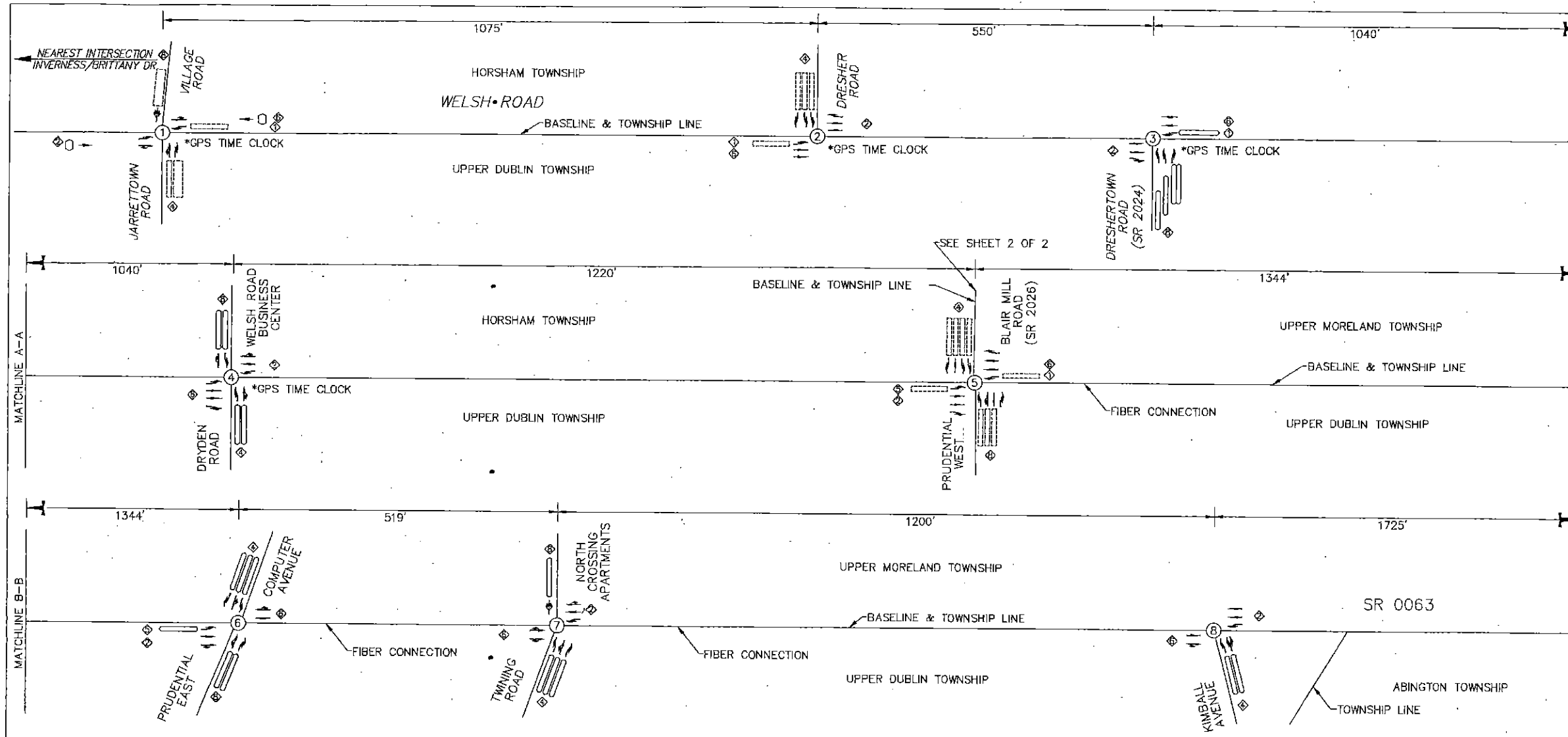

GENERAL NOTES

NO MODIFICATIONS OF THIS INSTALLATION ARE PERMITTED UNLESS PRIOR APPROVAL IS GRANTED IN WRITING BY A REPRESENTATIVE OF THE DEPARTMENT OF TRANSPORTATION.

REFER TO TRAFFIC SIGNAL PERMIT DRAWING FOR INDIVIDUAL INTERSECTION OPERATION, GEOMETRY, PHASING AND CRITICAL TIMES.

FOR CONSTRUCTION AND INSPECTION THE SYSTEM PERMIT SHOULD ALWAYS BE ACCOMPANIED WITH TRAFFIC SIGNAL PERMIT DRAWING.

TEST THE SYSTEM AT LOCAL INTERSECTION LEVEL, SUBSYSTEM LEVEL MASTER CONTROLLER LEVEL AND PERSONAL COMPUTER REMOTE DIAL UP LEVEL.

GATHER THE SYSTEM FAILURE CRITICAL ALARMS REPORT AND ARCHIVE THEM WHERE APPLICABLE.

SET UP PENNDOT DISTRICT 6-0 COMPUTER WITH THE SYSTEM DATABASE AND GRAPHICS. MODIFY THE DATABASE AND GRAPHICS FOR SYSTEMS REVISIONS.

ASSIGN LOOP DETECTORS AND PROGRAM THE CONTROLLERS TO GATHER TRAFFIC VOLUMES IN 15 MINUTE INTERVAL, WHERE APPLICABLE.

EXACT LOCATION OF DETECTORS SHALL BE DETERMINED PRIOR TO INSTALLATION BY A REPRESENTATIVE OF PENNDOT.

OBTAIN POLE ATTACHMENT PERMIT FOR AERIAL FIBER OPTIC INSTALLATION.

MAINTAIN MASTER CONTROLLER COMMUNICATION SUCH AS PHONE DROPS.

PRIOR TO INSTALLATION THE CONTRACTOR SHALL CONSULT WITH THE LOCAL OFFICIALS AND UTILITY COMPANIES TO RESOLVE ANY PROBLEMS WHICH MAY BE CREATED DUE TO THE LOCATION OF UTILITIES.

THIS DRAWING CANNOT BE USED AS A CONSTRUCTION DRAWING UNLESS THE PERMITTEE COMPLIES WITH THE LATEST PROVISIONS OF ACT 267, PREVENTION OF DAMAGE TO UNDERGROUND UTILITIES EFFECTIVE DATE DECEMBER 10, 1974.

WHEN LIQUID FUELS MONEY IS USED, SIGNAL INSTALLATION MUST CONFORM TO FORM 408 AND A COPY OF THE PROPOSED SPECIFICATIONS MUST BE SUBMITTED TO THE DISTRICT TRAFFIC UNIT FOR REVIEW PRIOR TO BIDDING.

PERMITTEE SHALL OBTAIN A HIGHWAY OCCUPANCY PERMIT FOR ANY CHANGES IN INTERSECTION GEOMETRY REGARDING EXCAVATION.

CONDUIT INSTALLED IN BITUMINOUS ROADWAY LESS THAN 5 YEARS OLD, OR CONCRETE ROADWAY REGARDLESS OF AGE, MUST BE BORED OR JACKED UNDER THE ROADWAY. INSTALL IN ACCORDANCE WITH TRAFFIC SIGNAL STANDARDS TC-8800 SERIES.

CYCLE / SPLIT / OFFSET

PROGRAM 1-		FILE #	PHASE								CYCLE	OFFSET#1	OFFSET#2	OFFSET REFERENCE
INTERSECTIONS			1	2	3	4	5	6	7	8				
52	BLAIR MILL RD/WIMMER RD/COMMERCE AVE	1914									MAX 2	FREE		
51	BLAIR MILL RD/SHOPPING CENTER DR	3579									MAX 1	FREE		
9	WELSH RD / FITZWATERTOWN RD	0148	13(LEAD)	35	14(LEAD)	38	19(LEAD)	29	14(LEAD)	38	100	79	TS2 1ST GREEN	
8	WELSH RD / KIMBALL AVE	1645		73		27		73			100	47	TS2 1ST GREEN	
7	WELSH RD / TWINING RD	1644		61		28(SPLIT)		61		13(SPLIT)	100	97	TS2 1ST GREEN	
6	WELSH RD / COMPUTER AVE	0526		33		32(SPLIT)	13(LEAD)	40		15(SPLIT)	100	0	TS2 1ST GREEN	
5	WELSH RD / BLAIR MILL RD	1046	14(LEAD)	51		19(SPLIT)	28(LEAD)	37		16(SPLIT)	100	41	TS2 1ST GREEN	
4	WELSH RD / DRYDEN RD	3215		69		31		69		31	100	41	TS2 1ST GREEN	
3	WELSH RD / DRESHERTOWN RD	1683	27(LEAD)	48				75		25	100	28	TS2 1ST GREEN	
2	WELSH RD / DRESHER RD	2071	14(LEAD)	56		30		70			100	38	TS2 1ST GREEN	
1	WELSH RD / JARRETTOWN RD	2385	14(LEAD)	67		25		75		25	100	26	TS2 1ST GREEN	

PROGRAM 2-		FILE #	PHASE								CYCLE	OFFSET#1	OFFSET#2	OFFSET REFERENCE
INTERSECTIONS			1	2	3	4	5	6	7	8				
52	BLAIR MILL RD/WIMMER RD/COMMERCE AVE	1914									MAX 2	FREE		
51	BLAIR MILL RD/SHOPPING CENTER DR	3579									MAX 1	FREE		
9	WELSH RD / FITZWATERTOWN RD	0148	13(LEAD)	47	14(LEAD)	46	18(LEAD)	42	14(LEAD)	46	120	83	TS2 1ST GREEN	
8	WELSH RD / KIMBALL AVE	1645		75		45		75			120	74	TS2 1ST GREEN	
7	WELSH RD / TWINING RD	1644		74		33(SPLIT)		74		13(SPLIT)	120	118	TS2 1ST GREEN	
6	WELSH RD / COMPUTER AVE	0526		77		28(SPLIT)	13(LEAD)	64		15(SPLIT)	120	0	TS2 1ST GREEN	
5	WELSH RD / BLAIR MILL RD	1046	31(LEAD)	52		21(SPLIT)	31(LEAD)	52		16(SPLIT)	120	17	TS2 1ST GREEN	
4	WELSH RD / DRYDEN RD	3215		89		31		89		31	120	62	TS2 1ST GREEN	
3	WELSH RD / DRESHERTOWN RD	1683	35(LEAD)	51				85		34	120	85	TS2 1ST GREEN	
2	WELSH RD / DRESHER RD	2071	36(LEAD)	43		38		81			120	85	TS2 1ST GREEN	
1	WELSH RD / JARRETTOWN RD	2385	22(LEAD)	56		32		88		32	120	33	TS2 1ST GREEN	

PROGRAM 3-		FILE #	PHASE								CYCLE	OFFSET#1	OFFSET#2	OFFSET REFERENCE
INTERSECTIONS			1	2	3	4	5	6	7	8				
52	BLAIR MILL RD/WIMMER RD/COMMERCE AVE	1914									MAX 2	FREE		
51	BLAIR MILL RD/SHOPPING CENTER DR	3579									MAX 1	FREE		
9	WELSH RD / FITZWATERTOWN RD	0148	13(LEAD)	47	14(LEAD)	46	31(LEAD)	29	14(LEAD)	46	120	89	TS2 1ST GREEN	
8	WELSH RD / KIMBALL AVE	1645		99		21		99			120	48	TS2 1ST GREEN	
7	WELSH RD / TWINING RD	1644		81		28(SPLIT)		81		13(SPLIT)	120	0	TS2 1ST GREEN	
6	WELSH RD / COMPUTER AVE	0526		70		31(SPLIT)	13(LEAD)	57		19(SPLIT)	120	0	TS2 1ST GREEN	
5	WELSH RD / BLAIR MILL RD	1046	14(LEAD)	57		33(SPLIT)	28(LEAD)	44		16(SPLIT)	120	11	TS2 1ST GREEN	
4	WELSH RD / DRYDEN RD	3215		72		48		72		48	120	59	TS2 1ST GREEN	
3	WELSH RD / DRESHERTOWN RD	1683	14(LEAD)	49				93		27	120	29	TS2 1ST GREEN	
2	WELSH RD / DRESHER RD	2071	25(LEAD)	55		40		80			120	77	TS2 1ST GREEN	
1	WELSH RD / JARRETTOWN RD	2385	27(LEAD)	62		31		89		31	120	5	TS2 1ST GREEN	

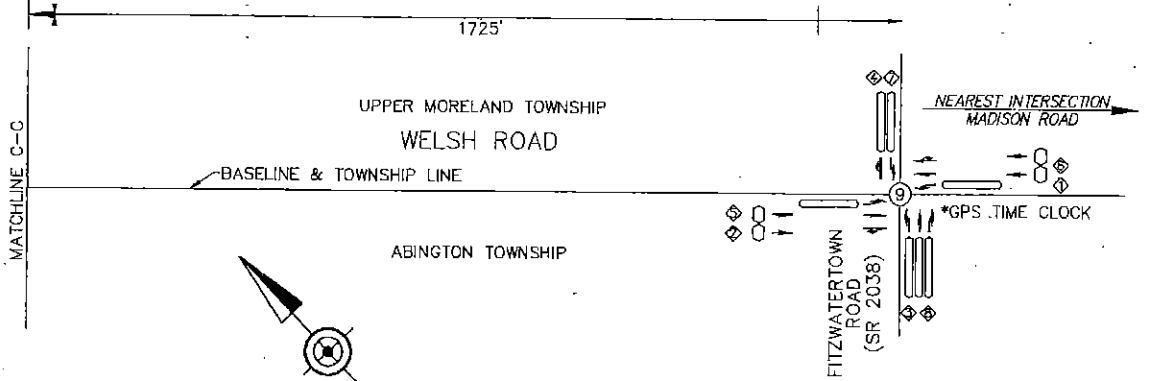

WEEKLY PROGRAM CHART

EVENT	DAY	TIME	PROGRAM	REMARKS
1	1-7	0000	MAXIMUM 1	FREE
2	1-5	0600	2	AM PEAK
3	1-5	0900	3	OFF PEAK
4	1-5	1500	3	PM PEAK
5	1-5	1900	1	OFF PEAK
6	6,7	0600	1	OFF PEAK

DAY 1 = MONDAY
 * MAX / FREE WHERE NOTED IN CYCLE / SPLIT / OFFSET MATRIX.

SYSTEM NOTES

- THE SIGNALS ALONG WELSH ROAD FROM JARRETTOWN ROAD TO FITZWATERTOWN ROAD ARE TO BE COORDINATED. THE SIGNALS ALONG WELSH ROAD FROM BLAIR MILL ROAD TO KIMBALL AVENUE ARE TO BE INTERCONNECTED. THE SIGNALS ALONG BLAIR MILL ROAD FROM WELSH ROAD TO WIMMER ROAD/COMMERCE AVENUE ARE TO BE INTERCONNECTED. ALL REMAINING SIGNALS ARE TO BE COORDINATED VIA GPS TIME CLOCK (INT #1-4 AND #9).
- PROGRAM TO BE SELECTED BY CLOSED LOOP SYSTEM (TIME OF DAY) OR TBC BACKUP.
- OFFSETS ARE REFERENCED TO EITHER THE BEGINNING OF YELLOW (PHASE 2+5) OR TO THE BEGINNING OF TS2 1ST GREEN (PHASE 2+6). PLEASE SEE CYCLE / SPLIT / OFFSET TABLE FOR APPROPRIATE OFFSET REFERENCE POINT.
- SYSTEM LIMITS: FOR EACH INTERSECTION, WELSH ROAD (SR 0063) - FROM JARRETTOWN ROAD TO FITZWATERTOWN ROAD (SR 2038). BLAIR MILL ROAD (SR 2026) - FROM WELSH ROAD (SR 0063) TO WIMMER ROAD/COMMERCE AVENUE. MASTER CONTROLLER: ON STREET MASTER WITH PHONE DROP AT WELSH ROAD (SR 0063) & COMPUTER AVENUE.
- PRIMARY COORDINATION: FIBER OPTIC CABLE. SECONDARY COORDINATION: TBC (DEFAULT TO BACKUP TBC).
- CYCLES, SPLITS & OFFSETS ARE IN SECONDS.

PENNSYLVANIA DEPARTMENT OF TRANSPORTATION
 ENGINEERING DISTRICT 6-0

COUNTY: MONTGOMERY
 MUNICIPALITY: UPPER DUBLIN & HORSHAM TWPS.
 UPPER MORELAND & ABINGTON TWPS.
 WELSH RD (SR 0063) JARRETTOWN TO FITZWATERTOWN

REVIEWED: *[Signature]* 7/16/05
 MUNICIPAL OFFICIAL

RECOMMENDED: *[Signature]* 12/14/04
 MUNICIPAL SIGNALS ENGINEER
 L. R. BELMONTE 12/14/04
 DISTRICT TRAFFIC ENGINEER

NO.	REVISION	DES/REV	DATE	REVW.	DATE	RECD	DATE
1	REVISED OFFSETS	TPD		KMC	3/11/05	LRB	3/15/05
2	RECONFIG LANES AT 5 & 6	KMC	5/22/06	KMC	5/22/06	LRB	5/22/06
3	ADD 80' BY 12" VPOLE BY PDS FOR 5' STAKE UP RETAINMENT POLE ON W. CORNER, CHANGING SIGN FOR SR 2 & 1, 2, 5 & 52. RELINE INT. 2, 3, 5	TPD	9/22/06	DK	9/28/06	LRB	10/2/08
4	PHASE LANE CONFIG FOR 04, INT 4, 1, 2, 5 & 52. RELINE INT. 2, 3, 5	TPD		DLA	1/19/10	AP	1/20/10
5	ADD CB LIT @ DRESHERTOWN, BL @ DRESHERTOWN ADD VIDEO DET. @ J-TURN & DRESHER	BURNS	8/17/15	DLA	7/4/16	AP	7/15/15

SHEET 1 OF 2 SYSTEM PERMIT # I-0098

APPENDIX C

Manual Turning Movement (MTM) Counts

McMahon Associates, Inc.

425 Commerce Drive, Suite 200
Fort Washington, P A 19034

Municipality: Upper Dublin Township
Location: Route 63 (Welsh Road) &
Jarrettown Road / Village Road
Counter/Board #: HP

File Name : prudential01w
Site Code : 81633301
Start Date : 2/18/2016
Page No : 1

Groups Printed- Passenger Vehicles - Heavy Vehicles

Start Time	Village Rd Southbound				Rt 63 (Welsh Rd) Westbound				Jarrettown Rd Northbound				Rt 63 (Welsh Rd) Eastbound				Int. Total
	Left	Thru	ROR	Right	Left	Thru	ROR	Right	Left	Thru	ROR	Right	Left	Thru	ROR	Right	
07:00	1	1	0	7	44	142	0	1	3	3	8	39	6	143	0	3	401
07:15	4	1	1	5	48	129	0	1	5	4	7	48	8	181	1	2	445
07:30	3	2	0	4	83	184	1	0	0	9	8	51	9	230	0	2	586
07:45	3	5	2	4	58	147	0	2	2	18	9	58	16	208	2	3	537
Total	11	9	3	20	233	602	1	4	10	34	32	196	39	762	3	10	1969
08:00	1	5	0	9	62	169	0	2	2	18	5	72	16	217	0	0	578
08:15	2	7	0	8	58	124	0	3	6	13	4	102	14	188	0	7	536
08:30	1	6	1	4	46	138	0	2	10	13	5	84	14	181	1	0	506
08:45	6	2	0	3	53	146	1	10	5	17	1	90	14	170	0	8	526
Total	10	20	1	24	219	577	1	17	23	61	15	348	58	756	1	15	2146
15:45	0	0	0	0	0	0	1	0	0	0	0	0	0	0	0	0	1
Total	0	0	0	0	0	0	1	0	0	0	0	0	0	0	0	0	1
16:00	3	5	1	16	49	202	0	3	5	5	4	44	5	140	1	1	484
16:15	5	3	0	8	45	210	0	8	3	5	4	50	3	166	0	0	510
16:30	6	2	2	16	53	217	0	4	0	6	5	34	4	150	0	2	501
16:45	2	13	4	13	52	227	0	5	3	9	6	52	7	144	1	7	545
Total	16	23	7	53	199	856	0	20	11	25	19	180	19	600	2	10	2040
17:00	17	26	3	30	54	241	0	3	8	8	5	42	2	167	0	4	610
17:15	10	30	4	25	68	225	1	2	2	2	7	51	5	166	0	4	602
17:30	11	20	2	22	56	212	0	3	3	1	2	43	7	184	0	6	572
17:45	3	10	1	9	58	168	0	0	6	6	8	42	7	163	1	1	483
Total	41	86	10	86	236	846	1	8	19	17	22	178	21	680	1	15	2267
Grand Total	78	138	21	183	887	2881	4	49	63	137	88	902	137	2798	7	50	8423
Apprch %	18.6	32.9	5	43.6	23.2	75.4	0.1	1.3	5.3	11.5	7.4	75.8	4.6	93.5	0.2	1.7	
Total %	0.9	1.6	0.2	2.2	10.5	34.2	0	0.6	0.7	1.6	1	10.7	1.6	33.2	0.1	0.6	
Passenger Vehicles	75	138	21	179	874	2819	4	49	61	136	88	891	134	2745	7	48	8269
% Passenger Vehicles	96.2	100	100	97.8	98.5	97.8	100	100	96.8	99.3	100	98.8	97.8	98.1	100	96	98.2
Heavy Vehicles	3	0	0	4	13	62	0	0	2	1	0	11	3	53	0	2	154
% Heavy Vehicles	3.8	0	0	2.2	1.5	2.2	0	0	3.2	0.7	0	1.2	2.2	1.9	0	4	1.8

McMahon Associates, Inc.

425 Commerce Drive, Suite 200
Fort Washington, P A 19034

Municipality: Upper Dublin Township
Location: Route 63 (Welsh Road) &
Jarrettown Road / Village Road
Counter/Board #: HP

File Name : prudential01w
Site Code : 81633301
Start Date : 2/18/2016
Page No : 2

Start Time	Village Rd Southbound					Rt 63 (Welsh Rd) Westbound					Jarrettown Rd Northbound					Rt 63 (Welsh Rd) Eastbound					Int. Total
	Left	Thru	ROR	Right	App. Total	Left	Thru	ROR	Right	App. Total	Left	Thru	ROR	Right	App. Total	Left	Thru	ROR	Right	App. Total	
Peak Hour Analysis From 07:00 to 11:45 - Peak 1 of 1																					
Peak Hour for Entire Intersection Begins at 07:30																					
07:30	3	2	0	4	9	83	184	1	0	268	0	9	8	51	68	9	230	0	2	241	586
07:45	3	5	2	4	14	58	147	0	2	207	2	18	9	58	87	16	208	2	3	229	537
08:00	1	5	0	9	15	62	169	0	2	233	2	18	5	72	97	16	217	0	0	233	578
08:15	2	7	0	8	17	58	124	0	3	185	6	13	4	102	125	14	188	0	7	209	536
Total Volume	9	19	2	25	55	261	624	1	7	893	10	58	26	283	377	55	843	2	12	912	2237
% App. Total	16.4	34.5	3.6	45.5		29.2	69.9	0.1	0.8		2.7	15.4	6.9	75.1		6	92.4	0.2	1.3		
PHF	.750	.679	.250	.694	.809	.786	.848	.250	.583	.833	.417	.806	.722	.694	.754	.859	.916	.250	.429	.946	.954
Passenger Vehicles	88.9	100	100	92.0	94.5	98.1	97.3	100	100	97.5	100	98.3	100	99.3	99.2	98.2	97.9	100	91.7	97.8	97.9
% Passenger Vehicles																					
Heavy Vehicles	11.1	0	0	8.0	5.5	1.9	2.7	0	0	2.5	0	1.7	0	0.7	0.8	1.8	2.1	0	8.3	2.2	2.1
% Heavy Vehicles																					

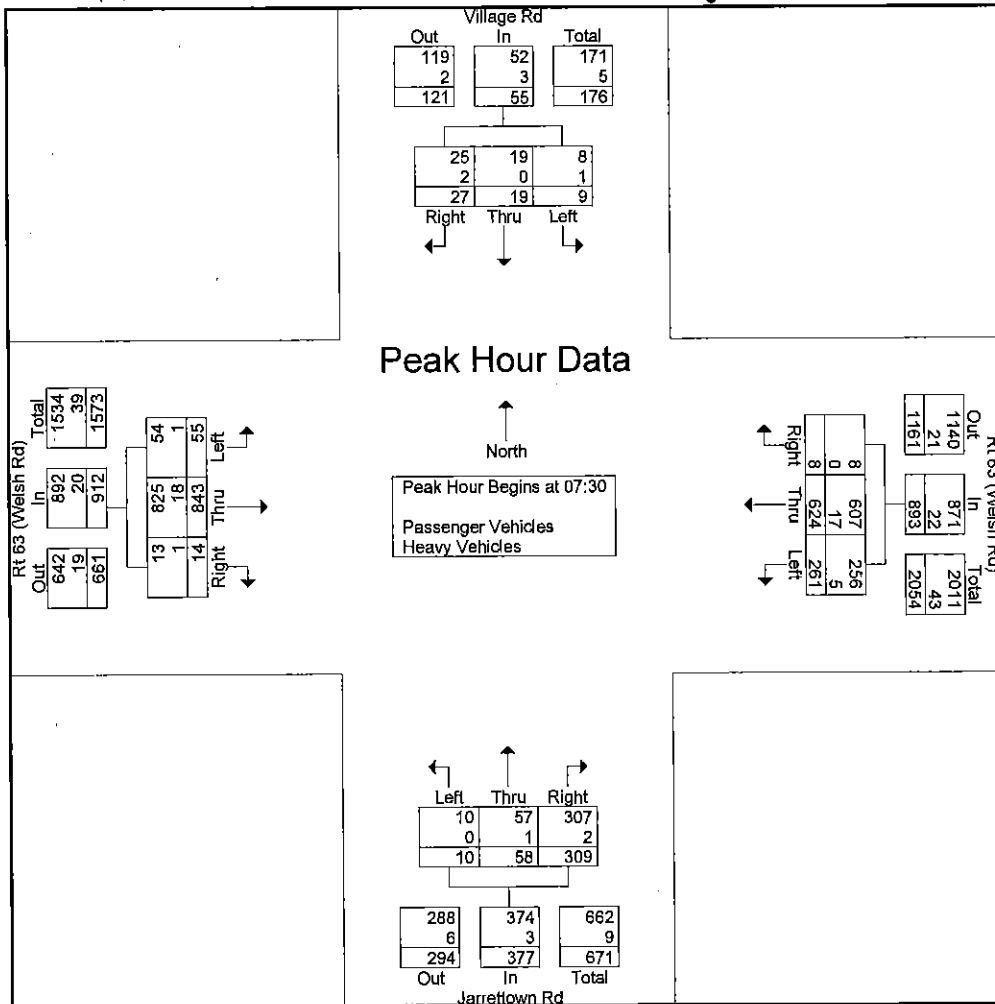

McMahon Associates, Inc.

425 Commerce Drive, Suite 200
Fort Washington, P A 19034

Municipality: Upper Dublin Township
Location: Route 63 (Welsh Road) &
Jarrettown Road / Village Road
Counter/Board #: HP

File Name : prudential01w
Site Code : 81633301
Start Date : 2/18/2016
Page No : 3

Start Time	Village Rd Southbound					Rt 63 (Welsh Rd) Westbound					Jarrettown Rd Northbound					Rt 63 (Welsh Rd) Eastbound					Int. Total
	Left	Thru	ROR	Right	App. Total	Left	Thru	ROR	Right	App. Total	Left	Thru	ROR	Right	App. Total	Left	Thru	ROR	Right	App. Total	
Peak Hour Analysis From 12:00 to 17:45 - Peak 1 of 1																					
Peak Hour for Entire Intersection Begins at 16:45																					
16:45	2	13	4	13	32	52	227	0	5	284	3	9	6	52	70	7	144	1	7	159	545
17:00	17	26	3	30	76	54	241	0	3	298	8	8	5	42	63	2	167	0	4	173	610
17:15	10	30	4	25	69	68	225	1	2	296	2	2	7	51	62	5	166	0	4	175	602
17:30	11	20	2	22	55	56	212	0	3	271	3	1	2	43	49	7	184	0	6	197	572
Total Volume	40	89	13	90	232	230	905	1	13	1149	16	20	20	188	244	21	661	1	21	704	2329
% App. Total	17.2	38.4	5.6	38.8		20	78.8	0.1	1.1		6.6	8.2	8.2	77		3	93.9	0.1	3		
PHF	.588	.742	.813	.750	.763	.846	.939	.250	.650	.964	.500	.556	.714	.904	.871	.750	.898	.250	.750	.893	.955
Passenger Vehicles																					
% Passenger Vehicles	97.5	100	100	100	99.6	99.6	99.6	100	100	99.6	100	100	100	99.5	99.6	100	99.2	100	100	99.3	99.5
Heavy Vehicles																					
% Heavy Vehicles	2.5	0	0	0	0.4	0.4	0.4	0	0	0.4	0	0	0	0.5	0.4	0	0.8	0	0	0.7	0.5

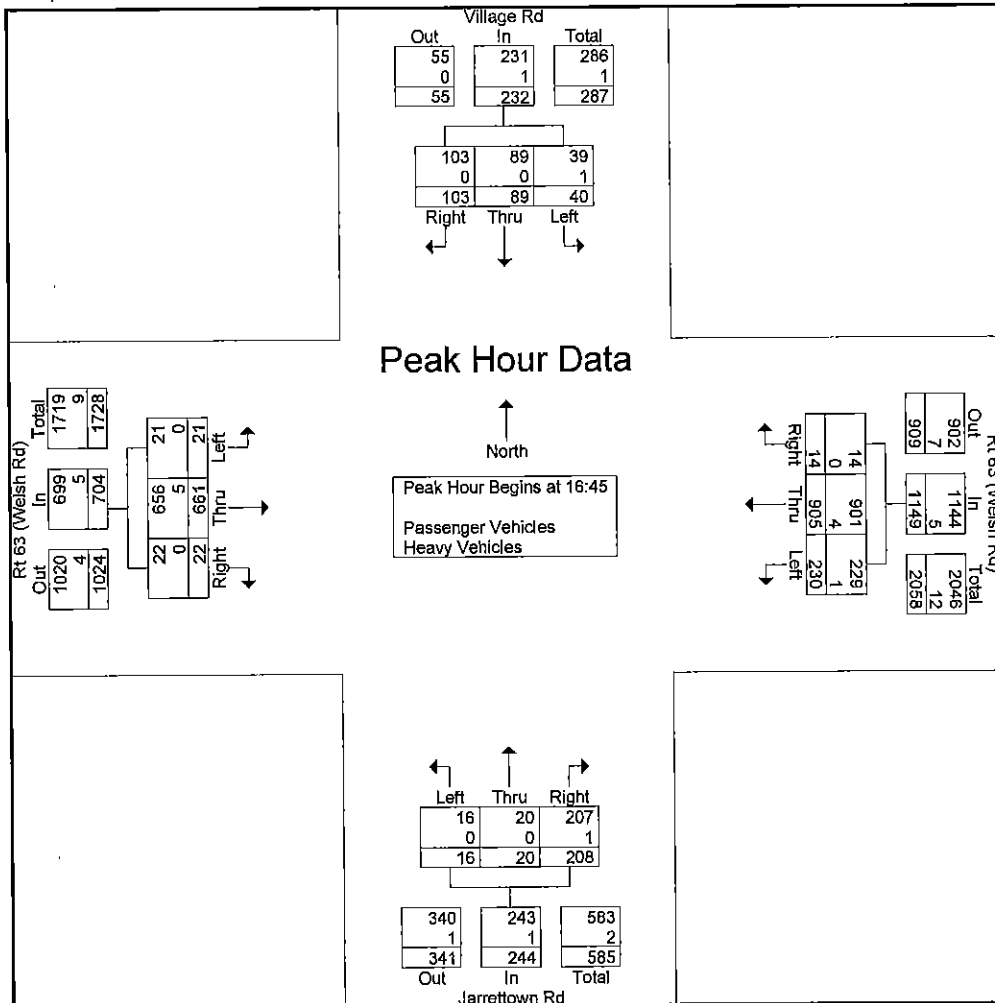

McMahon Associates, Inc.

425 Commerce Drive, Suite 200
Fort Washington, P A 19034

Municipality: Upper Dublin Township
Location: Route 63 (Welsh Road) &
Jarrettown Road / Village Road
Counter/Board #: HP

File Name : prudential01w
Site Code : 81633301
Start Date : 2/18/2016
Page No : 1

Groups Printed- Passenger Vehicles

Start Time	Village Rd Southbound				Rt 63 (Welsh Rd) Westbound				Jarrettown Rd Northbound				Rt 63 (Welsh Rd) Eastbound				Int. Total
	Left	Thru	ROR	Right	Left	Thru	ROR	Right	Left	Thru	ROR	Right	Left	Thru	ROR	Right	
07:00	1	1	0	7	44	135	0	1	3	3	8	39	5	139	0	2	388
07:15	4	1	1	3	48	127	0	1	5	4	7	46	8	179	1	2	437
07:30	3	2	0	3	83	180	1	0	0	9	8	50	9	224	0	2	574
07:45	3	5	2	4	57	144	0	2	2	18	9	58	16	204	2	3	529
Total	11	9	3	17	232	586	1	4	10	34	32	193	38	746	3	9	1928
08:00	1	5	0	9	60	162	0	2	2	17	5	71	16	213	0	0	563
08:15	1	7	0	7	56	121	0	3	6	13	4	102	13	184	0	6	523
08:30	1	6	1	4	45	131	0	2	8	13	5	84	14	170	1	0	485
08:45	5	2	0	3	51	128	1	10	5	17	1	88	13	168	0	8	500
Total	8	20	1	23	212	542	1	17	21	60	15	345	56	735	1	14	2071
15:45	0	0	0	0	0	0	1	0	0	0	0	0	0	0	0	0	1
Total	0	0	0	0	0	0	1	0	0	0	0	0	0	0	0	0	1
16:00	3	5	1	16	47	200	0	3	5	5	4	42	5	135	1	1	473
16:15	5	3	0	8	44	208	0	8	3	5	4	48	3	164	0	0	503
16:30	6	2	2	16	52	216	0	4	0	6	5	34	4	148	0	2	497
16:45	2	13	4	13	52	224	0	5	3	9	6	52	7	142	1	7	540
Total	16	23	7	53	195	848	0	20	11	25	19	176	19	589	2	10	2013
17:00	17	26	3	30	53	241	0	3	8	8	5	42	2	166	0	4	608
17:15	9	30	4	25	68	224	1	2	2	2	7	50	5	165	0	4	598
17:30	11	20	2	22	56	212	0	3	3	1	2	43	7	183	0	6	571
17:45	3	10	1	9	58	166	0	0	6	6	8	42	7	161	1	1	479
Total	40	86	10	86	235	843	1	8	19	17	22	177	21	675	1	15	2256
Grand Total	75	138	21	179	874	2819	4	49	61	136	88	891	134	2745	7	48	8269
Approch %	18.2	33.4	5.1	43.3	23.3	75.3	0.1	1.3	5.2	11.6	7.5	75.8	4.6	93.6	0.2	1.6	
Total %	0.9	1.7	0.3	2.2	10.6	34.1	0	0.6	0.7	1.6	1.1	10.8	1.6	33.2	0.1	0.6	

McMahon Associates, Inc.

425 Commerce Drive, Suite 200
Fort Washington, P A 19034

Municipality: Upper Dublin Township
Location: Route 63 (Welsh Road) &
Jarrettown Road / Village Road
Counter/Board #: HP

File Name : prudential01w
Site Code : 81633301
Start Date : 2/18/2016
Page No : 1

Groups Printed- Heavy Vehicles

Start Time	Village Rd Southbound				Rt 63 (Welsh Rd) Westbound				Jarrettown Rd Northbound				Rt 63 (Welsh Rd) Eastbound				Int. Total
	Left	Thru	ROR	Right	Left	Thru	ROR	Right	Left	Thru	ROR	Right	Left	Thru	ROR	Right	
07:00	0	0	0	0	0	7	0	0	0	0	0	0	1	4	0	1	13
07:15	0	0	0	2	0	2	0	0	0	0	0	2	0	2	0	0	8
07:30	0	0	0	1	0	4	0	0	0	0	0	1	0	6	0	0	12
07:45	0	0	0	0	1	3	0	0	0	0	0	0	0	4	0	0	8
Total	0	0	0	3	1	16	0	0	0	0	0	3	1	16	0	1	41
08:00	0	0	0	0	2	7	0	0	0	1	0	1	0	4	0	0	15
08:15	1	0	0	1	2	3	0	0	0	0	0	0	1	4	0	1	13
08:30	0	0	0	0	1	7	0	0	2	0	0	0	0	11	0	0	21
08:45	1	0	0	0	2	18	0	0	0	0	0	2	1	2	0	0	26
Total	2	0	0	1	7	35	0	0	2	1	0	3	2	21	0	1	75
16:00	0	0	0	0	2	2	0	0	0	0	0	2	0	5	0	0	11
16:15	0	0	0	0	1	2	0	0	0	0	0	2	0	2	0	0	7
16:30	0	0	0	0	1	1	0	0	0	0	0	0	0	2	0	0	4
16:45	0	0	0	0	0	3	0	0	0	0	0	0	0	2	0	0	5
Total	0	0	0	0	4	8	0	0	0	0	0	4	0	11	0	0	27
17:00	0	0	0	0	1	0	0	0	0	0	0	0	0	1	0	0	2
17:15	1	0	0	0	0	1	0	0	0	0	0	1	0	1	0	0	4
17:30	0	0	0	0	0	0	0	0	0	0	0	0	0	1	0	0	1
17:45	0	0	0	0	0	2	0	0	0	0	0	0	0	2	0	0	4
Total	1	0	0	0	1	3	0	0	0	0	0	1	0	5	0	0	11
Grand Total	3	0	0	4	13	62	0	0	2	1	0	11	3	53	0	2	154
Approch %	42.9	0	0	57.1	17.3	82.7	0	0	14.3	7.1	0	78.6	5.2	91.4	0	3.4	
Total %	1.9	0	0	2.6	8.4	40.3	0	0	1.3	0.6	0	7.1	1.9	34.4	0	1.3	

McMahon Associates, Inc.

425 Commerce Drive, Suite 200
Fort Washington, P A 19034

Municipality: Upper Dublin Township
Location: Route 63 (Welsh Rd) &
Jarrettown Road / Village Road
Counter/Board #: BW

File Name : prudential01s
Site Code : 81677701
Start Date : 2/20/2016
Page No : 1

Groups Printed- Passenger Vehicles - Heavy Vehicles

Start Time	Village Rd Southbound				Rt 63 (Welsh Rd) Westbound				Jarrettown Rd Northbound				Rt 63 (Welsh Rd) Eastbound				Int. Total
	Left	Thru	ROR	Right	Left	Thru	ROR	Right	Left	Thru	ROR	Right	Left	Thru	ROR	Right	
11:00	1	0	1	1	29	112	0	2	4	3	8	23	4	140	0	0	328
11:15	4	1	2	2	23	113	0	1	2	1	16	15	1	121	0	1	303
11:30	3	0	1	0	26	121	0	1	3	0	15	12	0	134	0	5	321
11:45	0	0	2	1	33	138	0	2	3	3	8	25	0	135	0	4	354
Total	8	1	6	4	111	484	0	6	12	7	47	75	5	530	0	10	1306
12:00	5	0	2	1	30	134	0	1	0	1	22	24	3	137	0	6	366
12:15	2	1	2	1	35	118	0	2	2	0	21	19	2	130	0	3	338
12:30	3	1	0	0	26	140	0	2	1	0	20	22	1	134	0	4	354
12:45	2	0	1	0	31	141	0	3	1	1	26	15	4	173	1	2	401
Total	12	2	5	2	122	533	0	8	4	2	89	80	10	574	1	15	1459
13:00	1	1	0	0	30	126	0	4	0	1	18	19	1	125	0	1	327
13:15	0	0	4	0	20	132	0	3	0	0	13	15	2	139	0	3	331
13:30	0	1	2	1	19	138	0	3	4	0	20	16	3	121	0	1	329
13:45	2	1	0	0	20	139	0	2	1	1	7	9	2	132	0	0	316
Total	3	3	6	1	89	535	0	12	5	2	58	59	8	517	0	5	1303
Grand Total	23	6	17	7	322	1552	0	26	21	11	194	214	23	1621	1	30	4068
Apprch %	43.4	11.3	32.1	13.2	16.9	81.7	0	1.4	4.8	2.5	44.1	48.6	1.4	96.8	0.1	1.8	
Total %	0.6	0.1	0.4	0.2	7.9	38.2	0	0.6	0.5	0.3	4.8	5.3	0.6	39.8	0	0.7	
Passenger Vehicles	23	5	17	7	320	1545	0	26	21	11	194	213	22	1610	1	26	4041
% Passenger Vehicles	100	83.3	100	100	99.4	99.5	0	100	100	100	100	99.5	95.7	99.3	100	86.7	99.3
Heavy Vehicles	0	1	0	0	2	7	0	0	0	0	0	1	1	11	0	4	27
% Heavy Vehicles	0	16.7	0	0	0.6	0.5	0	0	0	0	0	0.5	4.3	0.7	0	13.3	0.7

McMahon Associates, Inc.

425 Commerce Drive, Suite 200
Fort Washington, P A 19034

Municipality: Upper Dublin Township
Location: Route 63 (Welsh Rd) &
Jarrettown Road / Village Road
Counter/Board #: BW

File Name : prudential01s
Site Code : 81677701
Start Date : 2/20/2016
Page No : 2

Start Time	Village Rd Southbound					Rt 63 (Welsh Rd) Westbound					Jarrettown Rd Northbound					Rt 63 (Welsh Rd) Eastbound					Int. Total
	Left	Thru	ROR	Right	App. Total	Left	Thru	ROR	Right	App. Total	Left	Thru	ROR	Right	App. Total	Left	Thru	ROR	Right	App. Total	
Peak Hour Analysis From 11:00 to 13:45 - Peak 1 of 1																					
Peak Hour for Entire Intersection Begins at 12:00																					
12:00	5	0	2	1	8	30	134	0	1	165	0	1	22	24	47	3	137	0	6	146	366
12:15	2	1	2	1	6	35	118	0	2	155	2	0	21	19	42	2	130	0	3	135	338
12:30	3	1	0	0	4	26	140	0	2	168	1	0	20	22	43	1	134	0	4	139	354
12:45	2	0	1	0	3	31	141	0	3	175	1	1	26	15	43	4	173	1	2	180	401
Total Volume	12	2	5	2	21	122	533	0	8	663	4	2	89	80	175	10	574	1	15	600	1459
% App. Total	57.1	9.5	23.8	9.5		18.4	80.4	0	1.2		2.3	1.1	50.9	45.7		1.7	95.7	0.2	2.5		
PHF	.600	.500	.625	.500	.656	.871	.945	.000	.667	.947	.500	.500	.856	.833	.931	.625	.829	.250	.625	.833	.910
Passenger Vehicles																					
% Passenger Vehicles	100	100	100	100	100	98.4	99.6	0	100	99.4	100	100	100	100	100	100	99.0	100	73.3	98.3	99.0
Heavy Vehicles																					
% Heavy Vehicles	0	0	0	0	0	1.6	0.4	0	0	0.6	0	0	0	0	0	0	1.0	0	26.7	1.7	1.0

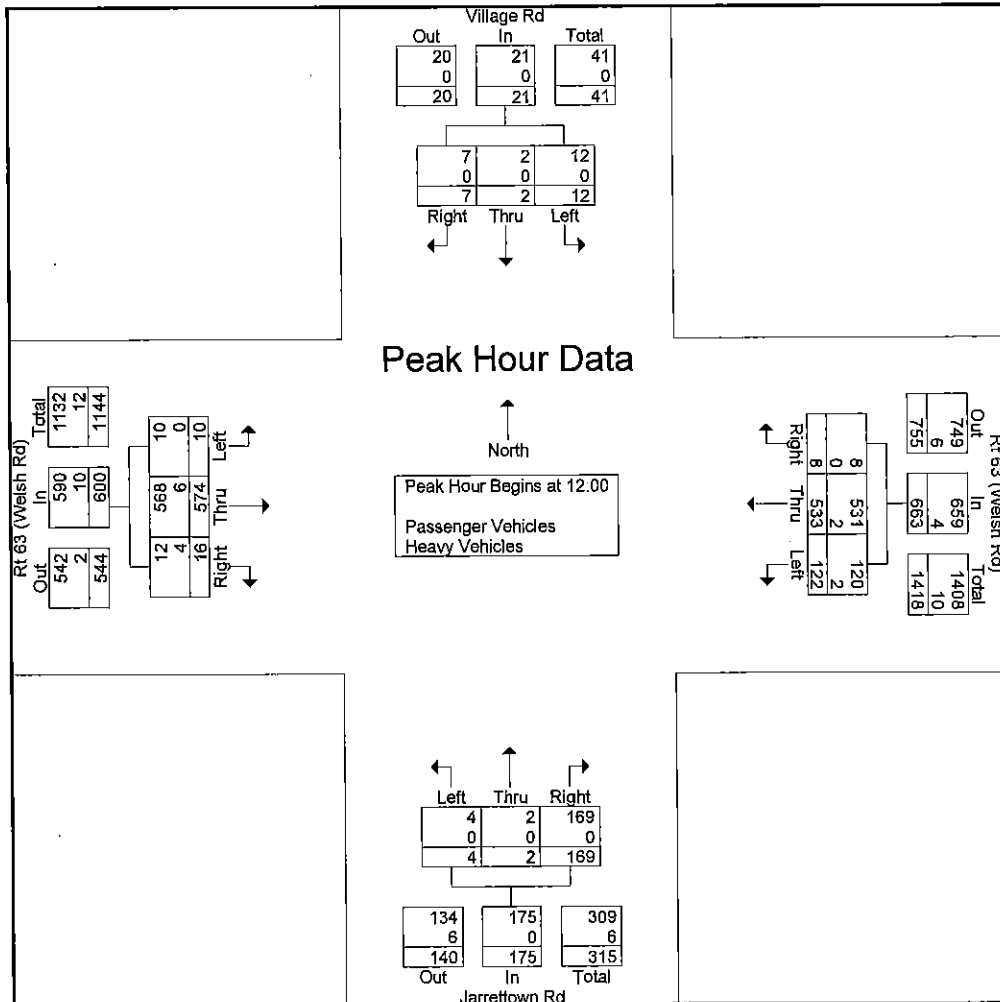

251

McMahon Associates, Inc.

425 Commerce Drive, Suite 200
Fort Washington, P A 19034

Municipality: Upper Dublin Township
Location: Route 63 (Welsh Rd) &
Jarrettown Road / Village Road
Counter/Board #: BW

File Name : prudential01s
Site Code : 81677701
Start Date : 2/20/2016
Page No : 1

Groups Printed- Passenger Vehicles

Start Time	Village Rd Southbound				Rt 63 (Welsh Rd) Westbound				Jarrettown Rd Northbound				Rt 63 (Welsh Rd) Eastbound				Int. Total
	Left	Thru	ROR	Right	Left	Thru	ROR	Right	Left	Thru	ROR	Right	Left	Thru	ROR	Right	
11:00	1	0	1	1	29	111	0	2	4	3	8	23	3	138	0	0	324
11:15	4	0	2	2	23	113	0	1	2	1	16	14	1	121	0	1	301
11:30	3	0	1	0	26	120	0	1	3	0	15	12	0	134	0	5	320
11:45	0	0	2	1	33	138	0	2	3	3	8	25	0	135	0	4	354
Total	8	0	6	4	111	482	0	6	12	7	47	74	4	528	0	10	1299
12:00	5	0	2	1	30	134	0	1	0	1	22	24	3	137	0	6	366
12:15	2	1	2	1	35	118	0	2	2	0	21	19	2	128	0	3	336
12:30	3	1	0	0	25	139	0	2	1	0	20	22	1	132	0	2	348
12:45	2	0	1	0	30	140	0	3	1	1	26	15	4	171	1	0	395
Total	12	2	5	2	120	531	0	8	4	2	89	80	10	568	1	11	1445
13:00	1	1	0	0	30	124	0	4	0	1	18	19	1	122	0	1	322
13:15	0	0	4	0	20	132	0	3	0	0	13	15	2	139	0	3	331
13:30	0	1	2	1	19	138	0	3	4	0	20	16	3	121	0	1	329
13:45	2	1	0	0	20	138	0	2	1	1	7	9	2	132	0	0	315
Total	3	3	6	1	89	532	0	12	5	2	58	59	8	514	0	5	1297
Grand Total	23	5	17	7	320	1545	0	26	21	11	194	213	22	1610	1	26	4041
Approch %	44.2	9.6	32.7	13.5	16.9	81.7	0	1.4	4.8	2.5	44.2	48.5	1.3	97	0.1	1.6	
Total %	0.6	0.1	0.4	0.2	7.9	38.2	0	0.6	0.5	0.3	4.8	5.3	0.5	39.8	0	0.6	

McMahon Associates, Inc.

425 Commerce Drive, Suite 200
Fort Washington, P A 19034

Municipality: Upper Dublin Township
Location: Route 63 (Welsh Rd) &
Jarrettown Road / Village Road
Counter/Board #: BW

File Name : prudential01s
Site Code : 81677701
Start Date : 2/20/2016
Page No : 1

Groups Printed- Heavy Vehicles

Start Time	Village Rd Southbound				Rt 63 (Welsh Rd) Westbound				Jarrettown Rd Northbound				Rt 63 (Welsh Rd) Eastbound				Int. Total
	Left	Thru	ROR	Right	Left	Thru	ROR	Right	Left	Thru	ROR	Right	Left	Thru	ROR	Right	
11:00	0	0	0	0	0	1	0	0	0	0	0	0	1	2	0	0	4
11:15	0	1	0	0	0	0	0	0	0	0	0	1	0	0	0	0	2
11:30	0	0	0	0	0	1	0	0	0	0	0	0	0	0	0	0	1
Total	0	1	0	0	0	2	0	0	0	0	0	1	1	2	0	0	7
12:15	0	0	0	0	0	0	0	0	0	0	0	0	0	2	0	0	2
12:30	0	0	0	0	1	1	0	0	0	0	0	0	0	2	0	2	6
12:45	0	0	0	0	1	1	0	0	0	0	0	0	0	2	0	2	6
Total	0	0	0	0	2	2	0	0	0	0	0	0	0	6	0	4	14
13:00	0	0	0	0	0	2	0	0	0	0	0	0	0	3	0	0	5
13:45	0	0	0	0	0	1	0	0	0	0	0	0	0	0	0	0	1
Total	0	0	0	0	0	3	0	0	0	0	0	0	0	3	0	0	6
Grand Total	0	1	0	0	2	7	0	0	0	0	0	1	1	11	0	4	27
Approch %	0	100	0	0	22.2	77.8	0	0	0	0	0	100	6.2	68.8	0	25	
Total %	0	3.7	0	0	7.4	25.9	0	0	0	0	3.7	3.7	40.7	0	14.8		

McMahon Associates, Inc.

425 Commerce Drive, Suite 200
Fort Washington, P A 19034

Municipality: Upper Dublin Township
Location: Welsh Road &
Dresher Road
Counter/Board#: JB

File Name : dryden03wr
Site Code : 81536703
Start Date : 12/3/2015
Page No : 1

Groups Printed- Passenger Vehicles - Heavy Vehicles

Start Time	Dresher Rd Southbound				Welsh Rd Westbound				Access Northbound				Welsh Rd Eastbound				Int. Total
	Left	Thru	ROR	Right	Left	Thru	ROR	Right	Left	Thru	ROR	Right	Left	Thru	ROR	Right	
07:00	159	0	15	48	0	176	5	66	0	0	0	0	48	141	0	0	658
07:15	161	0	8	50	0	166	9	73	0	0	0	0	66	142	0	0	675
07:30	148	0	1	86	0	189	0	118	0	0	0	0	81	194	0	0	817
07:45	164	0	1	72	0	168	0	174	0	0	0	0	98	211	0	0	888
Total	632	0	25	256	0	699	14	431	0	0	0	0	293	688	0	0	3038
08:00	159	0	0	65	0	178	3	139	0	0	0	0	92	192	0	0	828
08:15	150	0	1	52	0	153	3	131	0	0	0	0	116	206	0	0	812
08:30	144	0	1	53	0	159	0	137	0	0	0	0	102	207	0	0	803
08:45	146	0	0	36	0	185	0	192	0	0	0	0	100	187	0	0	846
Total	599	0	2	206	0	675	6	599	0	0	0	0	410	792	0	0	3289
16:00	142	0	0	72	0	205	0	109	0	0	0	0	38	180	0	0	746
16:15	144	0	1	63	0	206	0	120	0	0	0	0	43	170	0	0	747
16:30	185	0	0	87	0	227	0	129	0	0	0	0	58	188	0	0	874
16:45	195	0	0	74	0	231	0	115	0	0	0	0	65	187	0	0	867
Total	666	0	1	296	0	869	0	473	0	0	0	0	204	725	0	0	3234
17:00	212	0	0	130	0	237	0	146	0	0	0	0	49	203	0	0	977
17:15	215	0	0	94	0	232	0	139	0	0	0	0	80	211	0	0	971
17:30	197	0	0	86	0	181	0	127	0	0	0	0	78	219	0	0	888
17:45	173	0	0	62	0	198	0	119	0	0	0	0	73	203	0	0	828
Total	797	0	0	372	0	848	0	531	0	0	0	0	280	836	0	0	3664
Grand Total	2694	0	28	1130	0	3091	20	2034	0	0	0	0	1187	3041	0	0	13225
Apprch %	69.9	0	0.7	29.3	0	60.1	0.4	39.5	0	0	0	0	28.1	71.9	0	0	
Total %	20.4	0	0.2	8.5	0	23.4	0.2	15.4	0	0	0	0	9	23	0	0	
Passenger Vehicles	2657	0	28	1114	0	3043	20	1984	0	0	0	0	1168	2992	0	0	13006
% Passenger Vehicles	98.6	0	100	98.6	0	98.4	100	97.5	0	0	0	0	98.4	98.4	0	0	98.3
Heavy Vehicles	37	0	0	16	0	48	0	50	0	0	0	0	19	49	0	0	219
% Heavy Vehicles	1.4	0	0	1.4	0	1.6	0	2.5	0	0	0	0	1.6	1.6	0	0	1.7

McMahon Associates, Inc.

425 Commerce Drive, Suite 200
Fort Washington, P A 19034

Municipality: Upper Dublin Township
Location: Welsh Road &
Dresher Road
Counter/Board#: JB

File Name : dryden03wr
Site Code : 81536703
Start Date : 12/3/2015
Page No : 2

Start Time	Dresher Rd Southbound					Welsh Rd Westbound					Access Northbound					Welsh Rd Eastbound					Int. Total
	Left	Thru	ROR	Right	App. Total	Left	Thru	ROR	Right	App. Total	Left	Thru	ROR	Right	App. Total	Left	Thru	ROR	Right	App. Total	
Peak Hour Analysis From 07:00 to 11:45 - Peak 1 of 1																					
Peak Hour for Entire Intersection Begins at 07:30																					
07:30	148	0	1	86	235	0	189	0	118	307	0	0	0	0	0	81	194	0	0	275	817
07:45	164	0	1	72	237	0	168	0	174	342	0	0	0	0	0	98	211	0	0	309	888
08:00	159	0	0	65	224	0	178	3	139	320	0	0	0	0	0	92	192	0	0	284	828
08:15	150	0	1	52	203	0	153	3	131	287	0	0	0	0	0	116	206	0	0	322	812
Total Volume	621	0	3	275	899	0	688	6	562	1256	0	0	0	0	0	387	803	0	0	1190	3345
% App. Total	69.1	0	0.3	30.6		0	54.8	0.5	44.7		0	0	0	0	0	32.5	67.5	0	0		
PHF	.947	.000	.750	.799	.948	.000	.910	.500	.807	.918	.000	.000	.000	.000	.000	.834	.951	.000	.000	.924	.942
Passenger Vehicles	98.6	0	100	98.2	98.4	0	97.4	100	98.0	97.7	0	0	0	0	0	99.2	98.8	0	0	98.9	98.3
% Passenger Vehicles																					
Heavy Vehicles	1.4	0	0	1.8	1.6	0	2.6	0	2.0	2.3	0	0	0	0	0	0.8	1.2	0	0	1.1	1.7
% Heavy Vehicles																					

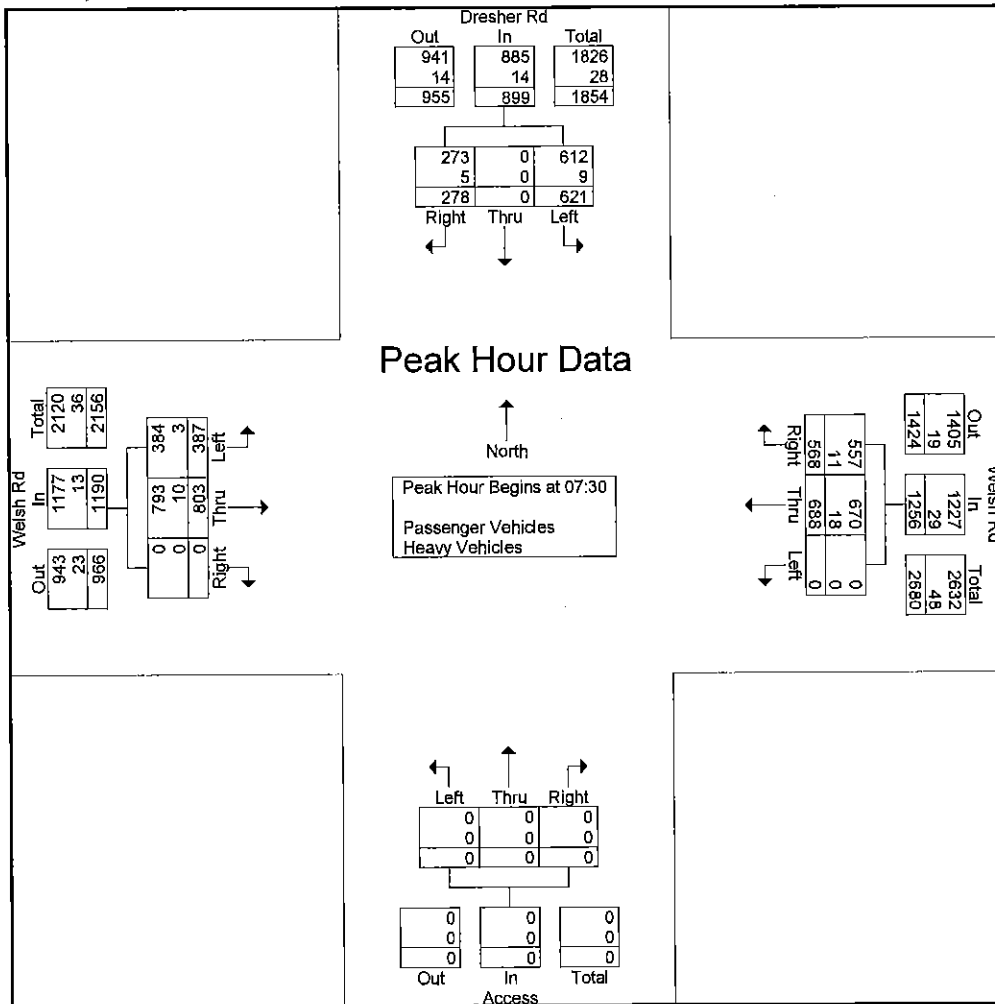

McMahon Associates, Inc.

425 Commerce Drive, Suite 200
Fort Washington, P A 19034

Municipality: Upper Dublin Township
Location: Welsh Road &
Dresher Road
Counter/Board#: JB

File Name : dryden03wr
Site Code : 81536703
Start Date : 12/3/2015
Page No : 3

Start Time	Dresher Rd Southbound					Welsh Rd Westbound					Access Northbound					Welsh Rd Eastbound					Int. Total
	Left	Thru	ROR	Right	App. Total	Left	Thru	ROR	Right	App. Total	Left	Thru	ROR	Right	App. Total	Left	Thru	ROR	Right	App. Total	
Peak Hour Analysis From 12:00 to 17:45 - Peak 1 of 1																					
Peak Hour for Entire Intersection Begins at 16:45																					
16:45	195	0	0	74	269	0	231	0	115	346	0	0	0	0	0	65	187	0	0	252	867
17:00	212	0	0	130	342	0	237	0	146	383	0	0	0	0	0	49	203	0	0	252	977
17:15	215	0	0	94	309	0	232	0	139	371	0	0	0	0	0	80	211	0	0	291	971
17:30	197	0	0	86	283	0	181	0	127	308	0	0	0	0	0	78	219	0	0	297	888
Total Volume	819	0	0	384	1203	0	881	0	527	1408	0	0	0	0	0	272	820	0	0	1092	3703
% App. Total	68.1	0	0	31.9		0	62.6	0	37.4		0	0	0	0	0	24.9	75.1	0	0		
PHF	.952	.000	.000	.738	.879	.000	.929	.000	.902	.919	.000	.000	.000	.000	.000	.850	.936	.000	.000	.919	.948
Passenger Vehicles	99.0	0	0	99.5	99.2	0	99.2	0	99.2	99.2	0	0	0	0	0	98.9	98.4	0	0	98.5	99.0
% Passenger Vehicles	1.0	0	0	0.5	0.8	0	0.8	0	0.8	0.8	0	0	0	0	0	1.1	1.6	0	0	1.5	1.0
% Heavy Vehicles																					

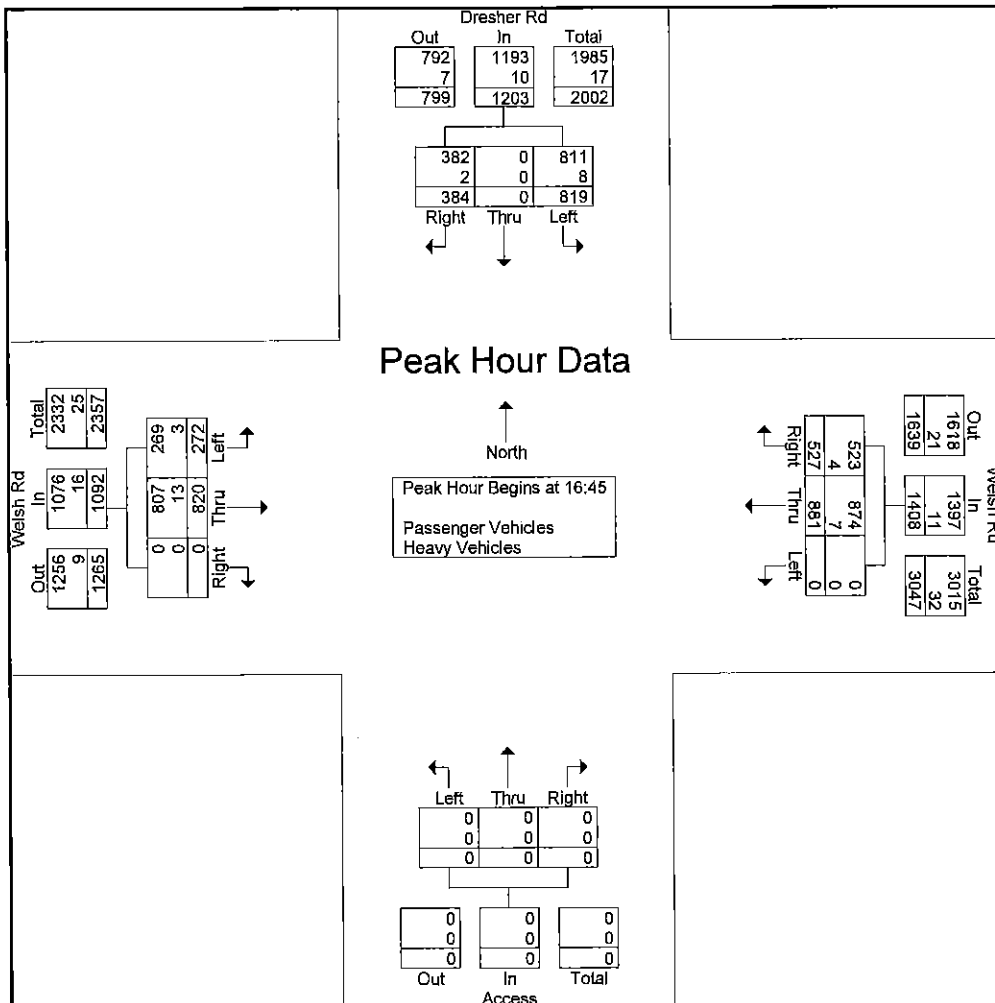

McMahon Associates, Inc.

425 Commerce Drive, Suite 200
Fort Washington, P A 19034

Municipality: Upper Dublin Township
Location: Welsh Road &
Dresher Road
Counter/Board#: JB

File Name : dryden03wr
Site Code : 81536703
Start Date : 12/3/2015
Page No : 1

Groups Printed- Passenger Vehicles

Start Time	Dresher Rd Southbound				Welsh Rd Westbound				Access Northbound				Welsh Rd Eastbound				Int. Total
	Left	Thru	ROR	Right	Left	Thru	ROR	Right	Left	Thru	ROR	Right	Left	Thru	ROR	Right	
07:00	159	0	15	43	0	176	5	64	0	0	0	0	46	139	0	0	647
07:15	157	0	8	49	0	163	9	72	0	0	0	0	65	138	0	0	661
07:30	147	0	1	85	0	186	0	114	0	0	0	0	81	193	0	0	807
07:45	161	0	1	70	0	162	0	171	0	0	0	0	97	209	0	0	871
Total	624	0	25	247	0	687	14	421	0	0	0	0	289	679	0	0	2986
08:00	158	0	0	65	0	174	3	138	0	0	0	0	91	188	0	0	817
08:15	146	0	1	50	0	148	3	128	0	0	0	0	115	203	0	0	794
08:30	139	0	1	53	0	155	0	136	0	0	0	0	100	203	0	0	787
08:45	145	0	0	36	0	180	0	176	0	0	0	0	97	183	0	0	817
Total	588	0	2	204	0	657	6	578	0	0	0	0	403	777	0	0	3215
16:00	139	0	0	71	0	203	0	106	0	0	0	0	37	178	0	0	734
16:15	142	0	1	63	0	204	0	112	0	0	0	0	40	169	0	0	731
16:30	182	0	0	85	0	222	0	127	0	0	0	0	57	185	0	0	858
16:45	194	0	0	73	0	228	0	114	0	0	0	0	64	185	0	0	858
Total	657	0	1	292	0	857	0	459	0	0	0	0	198	717	0	0	3181
17:00	211	0	0	130	0	235	0	145	0	0	0	0	48	199	0	0	968
17:15	213	0	0	94	0	231	0	138	0	0	0	0	80	208	0	0	964
17:30	193	0	0	85	0	180	0	126	0	0	0	0	77	215	0	0	876
17:45	171	0	0	62	0	196	0	117	0	0	0	0	73	197	0	0	816
Total	788	0	0	371	0	842	0	526	0	0	0	0	278	819	0	0	3624
Grand Total	2657	0	28	1114	0	3043	20	1984	0	0	0	0	1168	2992	0	0	13006
Apprch %	69.9	0	0.7	29.3	0	60.3	0.4	39.3	0	0	0	0	28.1	71.9	0	0	
Total %	20.4	0	0.2	8.6	0	23.4	0.2	15.3	0	0	0	0	9	23	0	0	

McMahon Associates, Inc.

425 Commerce Drive, Suite 200
Fort Washington, P A 19034

Municipality: Upper Dublin Township
Location: Welsh Road &
Dresher Road
Counter/Board#: JB

File Name : dryden03wr
Site Code : 81536703
Start Date : 12/3/2015
Page No : 1

Groups Printed- Heavy Vehicles

Start Time	Dresher Rd Southbound				Welsh Rd Westbound				Access Northbound				Welsh Rd Eastbound				Int. Total
	Left	Thru	ROR	Right	Left	Thru	ROR	Right	Left	Thru	ROR	Right	Left	Thru	ROR	Right	
07:00	0	0	0	5	0	0	0	2	0	0	0	0	2	2	0	0	11
07:15	4	0	0	1	0	3	0	1	0	0	0	0	1	4	0	0	14
07:30	1	0	0	1	0	3	0	4	0	0	0	0	0	1	0	0	10
07:45	3	0	0	2	0	6	0	3	0	0	0	0	1	2	0	0	17
Total	8	0	0	9	0	12	0	10	0	0	0	0	4	9	0	0	52
08:00	1	0	0	0	0	4	0	1	0	0	0	0	1	4	0	0	11
08:15	4	0	0	2	0	5	0	3	0	0	0	0	1	3	0	0	18
08:30	5	0	0	0	0	4	0	1	0	0	0	0	2	4	0	0	16
08:45	1	0	0	0	0	5	0	16	0	0	0	0	3	4	0	0	29
Total	11	0	0	2	0	18	0	21	0	0	0	0	7	15	0	0	74
16:00	3	0	0	1	0	2	0	3	0	0	0	0	1	2	0	0	12
16:15	2	0	0	0	0	2	0	8	0	0	0	0	3	1	0	0	16
16:30	3	0	0	2	0	5	0	2	0	0	0	0	1	3	0	0	16
16:45	1	0	0	1	0	3	0	1	0	0	0	0	1	2	0	0	9
Total	9	0	0	4	0	12	0	14	0	0	0	0	6	8	0	0	53
17:00	1	0	0	0	0	2	0	1	0	0	0	0	1	4	0	0	9
17:15	2	0	0	0	0	1	0	1	0	0	0	0	0	3	0	0	7
17:30	4	0	0	1	0	1	0	1	0	0	0	0	1	4	0	0	12
17:45	2	0	0	0	0	2	0	2	0	0	0	0	0	6	0	0	12
Total	9	0	0	1	0	6	0	5	0	0	0	0	2	17	0	0	40
Grand Total	37	0	0	16	0	48	0	50	0	0	0	0	19	49	0	0	219
Approch %	69.8	0	0	30.2	0	49	0	51	0	0	0	0	27.9	72.1	0	0	
Total %	16.9	0	0	7.3	0	21.9	0	22.8	0	0	0	0	8.7	22.4	0	0	

McMahon Associates, Inc.

425 Commerce Drive, Suite 200
Fort Washington, P A 19034

Municipality: Upper Dublin Township
Location: Welsh Road (Route 63) &
Dresher Road
Counter/Board #: BW

File Name : pru03s
Site Code : 81600001
Start Date : 1/9/2016
Page No : 1

Groups Printed- Passenger Vehicles - Heavy Vehicles

Start Time	Dresher Rd Southbound			Welsh Rd (Rt 63) Westbound			Welsh Rd (Rt 63) Eastbound		Int. Total
	Left	ROR	Right	Thru	ROR	Right	Left	Thru	
11:00	71	2	33	119	1	60	16	127	429
11:15	70	1	36	124	1	72	25	142	471
11:30	72	1	20	140	0	67	18	151	469
11:45	62	2	23	156	0	61	19	153	476
Total	275	6	112	539	2	260	78	573	1845
12:00	95	1	31	112	2	69	17	138	465
12:15	94	4	23	147	1	80	26	147	522
12:30	70	5	33	161	2	87	30	184	572
12:45	79	1	20	144	2	83	42	169	540
Total	338	11	107	564	7	319	115	638	2099
13:00	62	2	31	133	4	86	26	151	495
13:15	64	4	21	149	2	63	19	156	478
13:30	47	2	31	175	1	57	21	161	495
13:45	67	2	32	171	1	80	28	147	528
Total	240	10	115	628	8	286	94	615	1996
Grand Total	853	27	334	1731	17	865	287	1826	5940
Apprch %	70.3	2.2	27.5	66.2	0.7	33.1	13.6	86.4	
Total %	14.4	0.5	5.6	29.1	0.3	14.6	4.8	30.7	
Passenger Vehicles	845	27	329	1719	17	857	282	1814	5890
% Passenger Vehicles	99.1	100	98.5	99.3	100	99.1	98.3	99.3	99.2
Heavy Vehicles	8	0	5	12	0	8	5	12	50
% Heavy Vehicles	0.9	0	1.5	0.7	0	0.9	1.7	0.7	0.8

McMahon Associates, Inc.

425 Commerce Drive, Suite 200
Fort Washington, P A 19034

Municipality: Upper Dublin Township
Location: Welsh Road (Route 63) &
Dresher Road
Counter/Board #: BW

File Name : pr03s
Site Code : 81600001
Start Date : 1/9/2016
Page No : 2

Start Time	Dresher Rd Southbound				Welsh Rd (Rt 63) Westbound				Welsh Rd (Rt 63) Eastbound			Int. Total
	Left	ROR	Right	App. Total	Thru	ROR	Right	App. Total	Left	Thru	App. Total	
Peak Hour Analysis From 11:00 to 13:45 - Peak 1 of 1												
Peak Hour for Entire Intersection Begins at 12:15												
12:15	94	4	23	121	147	1	80	228	26	147	173	522
12:30	70	5	33	108	161	2	87	250	30	184	214	572
12:45	79	1	20	100	144	2	83	229	42	169	211	540
13:00	62	2	31	95	133	4	86	223	26	151	177	495
Total Volume	305	12	107	424	585	9	336	930	124	651	775	2129
% App. Total	71.9	2.8	25.2		62.9	1	36.1		16	84		
PHF	.811	.600	.811	.876	.908	.563	.966	.930	.738	.885	.905	.931
Passenger Vehicles	304	12	105	421	579	9	336	924	121	644	765	2110
% Passenger Vehicles	99.7	100	98.1	99.3	99.0	100	100	99.4	97.6	98.9	98.7	99.1
Heavy Vehicles	1	0	2	3	6	0	0	6	3	7	10	19
% Heavy Vehicles	0.3	0	1.9	0.7	1.0	0	0	0.6	2.4	1.1	1.3	0.9

24

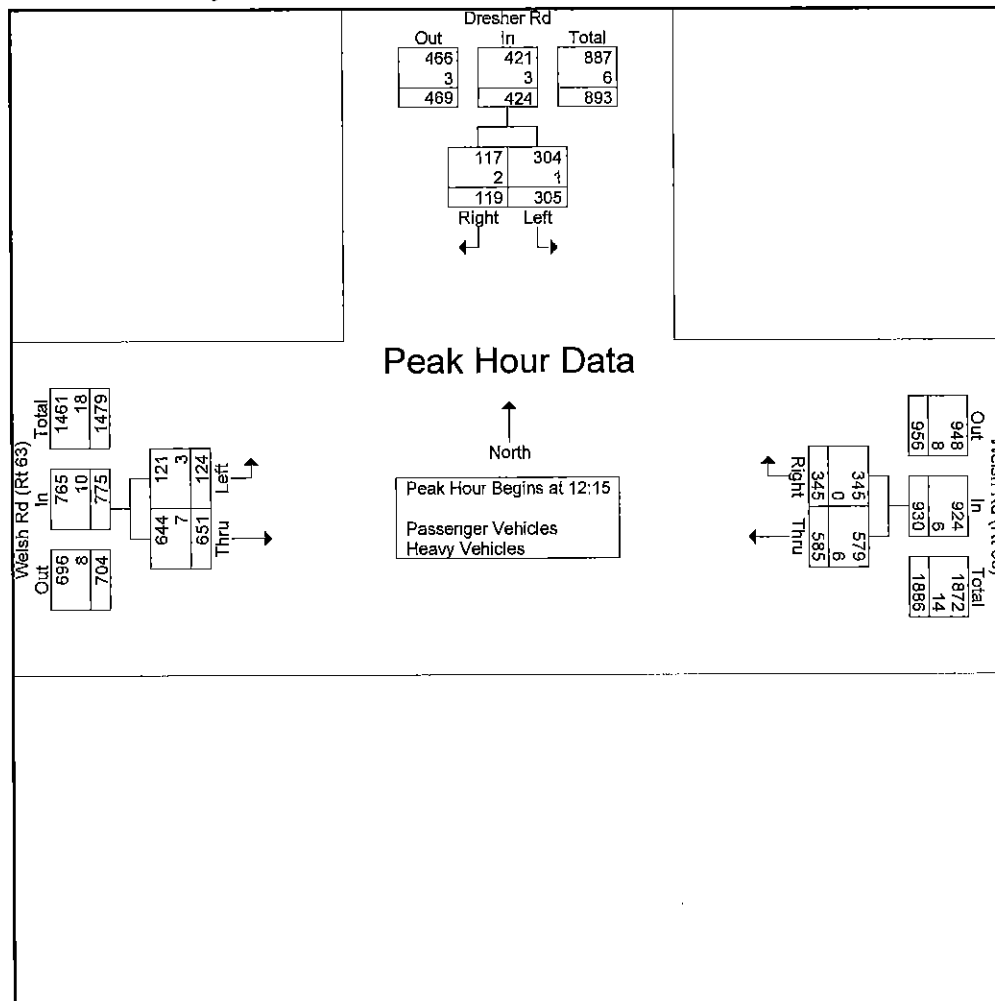

McMahon Associates, Inc.

425 Commerce Drive, Suite 200
Fort Washington, P A 19034

Municipality: Upper Dublin Township
Location: Welsh Road (Route 63) &
Dresher Road
Counter/Board #: BW

File Name : pru03s
Site Code : 81600001
Start Date : 1/9/2016
Page No : 1

Groups Printed- Passenger Vehicles

Start Time	Dresher Rd Southbound			Welsh Rd (Rt 63) Westbound			Welsh Rd (Rt 63) Eastbound		Int. Total
	Left	ROR	Right	Thru	ROR	Right	Left	Thru	
11:00	67	2	33	119	1	60	16	127	425
11:15	70	1	35	121	1	69	25	141	463
11:30	70	1	18	140	0	67	18	151	465
11:45	62	2	23	154	0	59	18	152	470
Total	269	6	109	534	2	255	77	571	1823
12:00	95	1	31	112	2	68	17	138	464
12:15	94	4	22	146	1	80	24	144	515
12:30	70	5	33	156	2	87	30	183	566
12:45	79	1	20	144	2	83	41	166	536
Total	338	11	106	558	7	318	112	631	2081
13:00	61	2	30	133	4	86	26	151	493
13:15	64	4	21	149	2	63	18	154	475
13:30	46	2	31	175	1	55	21	161	492
13:45	67	2	32	170	1	80	28	146	526
Total	238	10	114	627	8	284	93	612	1986
Grand Total	845	27	329	1719	17	857	282	1814	5890
Apprch %	70.4	2.2	27.4	66.3	0.7	33.1	13.5	86.5	
Total %	14.3	0.5	5.6	29.2	0.3	14.6	4.8	30.8	

McMahon Associates, Inc.

425 Commerce Drive, Suite 200
Fort Washington, P A 19034

Municipality: Upper Dublin Township
Location: Welsh Road (Route 63) &
Dresher Road
Counter/Board #: BW

File Name : pru03s
Site Code : 81600001
Start Date : 1/9/2016
Page No : 1

Groups Printed- Heavy Vehicles

Start Time	Dresher Rd Southbound			Welsh Rd (Rt 63) Westbound			Welsh Rd (Rt 63) Eastbound		Int. Total
	Left	ROR	Right	Thru	ROR	Right	Left	Thru	
11:00	4	0	0	0	0	0	0	0	4
11:15	0	0	1	3	0	3	0	1	8
11:30	2	0	2	0	0	0	0	0	4
11:45	0	0	0	2	0	2	1	1	6
Total	6	0	3	5	0	5	1	2	22
12:00	0	0	0	0	0	1	0	0	1
12:15	0	0	1	1	0	0	2	3	7
12:30	0	0	0	5	0	0	0	1	6
12:45	0	0	0	0	0	0	1	3	4
Total	0	0	1	6	0	1	3	7	18
13:00	1	0	1	0	0	0	0	0	2
13:15	0	0	0	0	0	0	1	2	3
13:30	1	0	0	0	0	2	0	0	3
13:45	0	0	0	1	0	0	0	1	2
Total	2	0	1	1	0	2	1	3	10
Grand Total	8	0	5	12	0	8	5	12	50
Apprch %	61.5	0	38.5	60	0	40	29.4	70.6	
Total %	16	0	10	24	0	16	10	24	

McMahon Associates, Inc.

425 Commerce Drive, Suite 200
Fort Washington, P A 19034

Municipality: Upper Dublin Township
Location: Welsh Road &
Dreshertown Road
Counter/Board #: LB

File Name : dryden02wR
Site Code : 81536702
Start Date : 12/3/2015
Page No : 1

Groups Printed- Passenger Vehicles - Heavy Vehicles

Start Time	Welsh Rd Westbound		Dreshertown Rd Northbound			Welsh Rd Eastbound			Int. Total
	Left	Thru	Left	ROR	Right	Thru	ROR	Right	
07:00	77	157	30	16	23	158	10	101	572
07:15	97	163	49	25	51	131	11	104	631
07:30	107	220	58	23	66	238	15	99	826
07:45	84	235	69	28	78	205	14	96	809
Total	365	775	206	92	218	732	50	400	2838
08:00	115	226	62	16	81	192	8	117	817
08:15	98	219	63	14	67	198	6	132	797
08:30	92	162	46	24	60	220	11	112	727
08:45	81	155	57	6	60	164	4	113	640
Total	386	762	228	60	268	774	29	474	2981
16:00	94	200	61	27	43	176	13	106	720
16:15	79	198	54	12	57	180	8	93	681
16:30	87	204	72	22	79	177	14	100	755
16:45	84	187	74	13	68	191	8	110	735
Total	344	789	261	74	247	724	43	409	2891
17:00	113	269	96	18	85	241	10	127	959
17:15	140	243	91	12	120	265	7	112	990
17:30	109	251	89	5	93	279	3	138	967
17:45	85	219	97	9	101	252	5	131	899
Total	447	982	373	44	399	1037	25	508	3815
Grand Total	1542	3308	1068	270	1132	3267	147	1791	12525
Apprch %	31.8	68.2	43.2	10.9	45.8	62.8	2.8	34.4	
Total %	12.3	26.4	8.5	2.2	9	26.1	1.2	14.3	
Passenger Vehicles	1506	3240	1042	270	1080	3208	147	1758	12251
% Passenger Vehicles	97.7	97.9	97.6	100	95.4	98.2	100	98.2	97.8
Heavy Vehicles	36	68	26	0	52	59	0	33	274
% Heavy Vehicles	2.3	2.1	2.4	0	4.6	1.8	0	1.8	2.2

McMahon Associates, Inc.

425 Commerce Drive, Suite 200
Fort Washington, P A 19034

Municipality: Upper Dublin Township
Location: Welsh Road &
Dreshertown Road
Counter/Board #: LB

File Name : dryden02wR
Site Code : 81536702
Start Date : 12/3/2015
Page No : 2

Start Time	Welsh Rd Westbound			Dreshertown Rd Northbound				Welsh Rd Eastbound				Int. Total
	Left	Thru	App. Total	Left	ROR	Right	App. Total	Thru	ROR	Right	App. Total	
Peak Hour Analysis From 07:00 to 11:45 - Peak 1 of 1												
Peak Hour for Entire Intersection Begins at 07:30												
07:30	107	220	327	58	23	66	147	238	15	99	352	826
07:45	84	235	319	69	28	78	175	205	14	96	315	809
08:00	115	226	341	62	16	81	159	192	8	117	317	817
08:15	98	219	317	63	14	67	144	198	6	132	336	797
Total Volume	404	900	1304	252	81	292	625	833	43	444	1320	3249
% App. Total	31	69		40.3	13	46.7		63.1	3.3	33.6		
PHF	.878	.957	.956	.913	.723	.901	.893	.875	.717	.841	.938	.983
Passenger Vehicles	394	872	1266	242	81	280	603	822	43	430	1295	3164
% Passenger Vehicles	97.5	96.9	97.1	96.0	100	95.9	96.5	98.7	100	96.8	98.1	97.4
Heavy Vehicles	10	28	38	10	0	12	22	11	0	14	25	85
% Heavy Vehicles	2.5	3.1	2.9	4.0	0	4.1	3.5	1.3	0	3.2	1.9	2.6

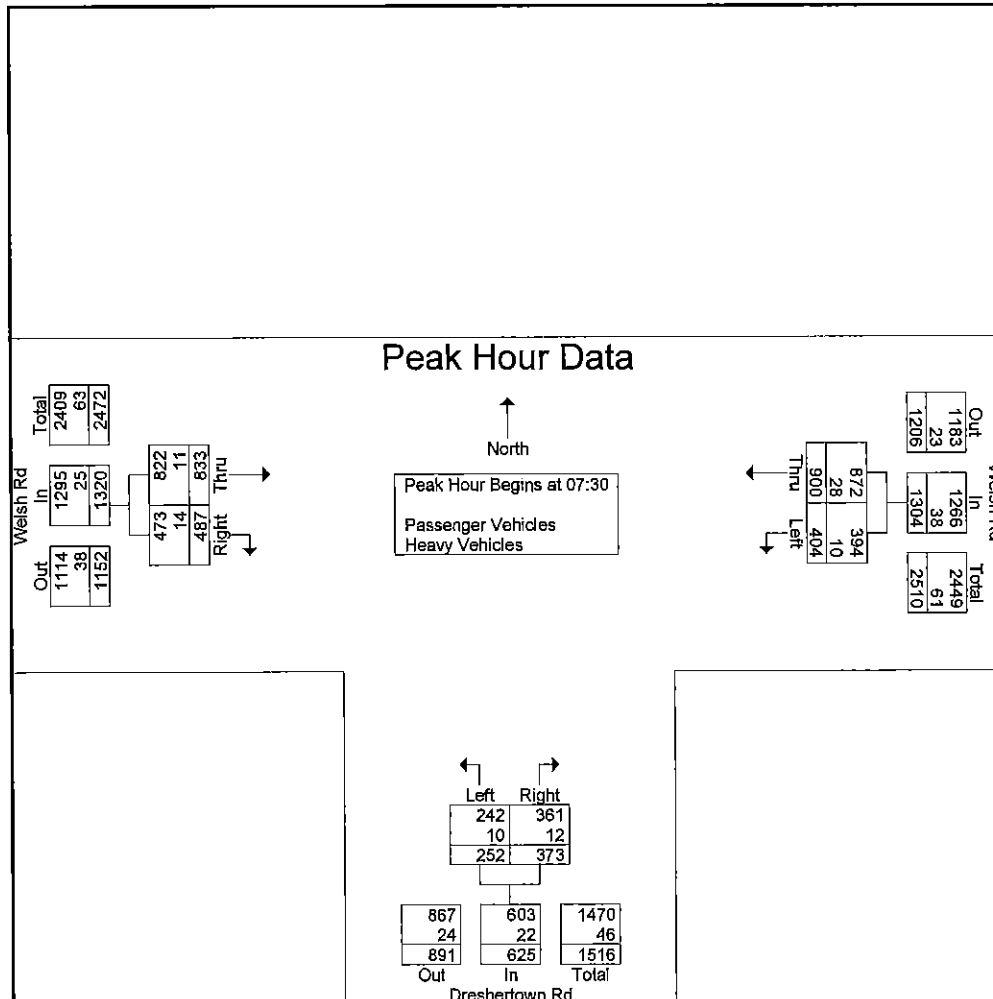

McMahon Associates, Inc.

425 Commerce Drive, Suite 200
Fort Washington, P A 19034

Municipality: Upper Dublin Township
Location: Welsh Road &
Dreshertown Road
Counter/Board #: LB

File Name : dryden02wR
Site Code : 81536702
Start Date : 12/3/2015
Page No : 3

Start Time	Welsh Rd Westbound			Dreshertown Rd Northbound				Welsh Rd Eastbound				Int. Total
	Left	Thru	App. Total	Left	ROR	Right	App. Total	Thru	ROR	Right	App. Total	
Peak Hour Analysis From 12:00 to 17:45 - Peak 1 of 1												
Peak Hour for Entire Intersection Begins at 17:00												
17:00	113	269	382	96	18	85	199	241	10	127	378	959
17:15	140	243	383	91	12	120	223	265	7	112	384	990
17:30	109	251	360	89	5	93	187	279	3	138	420	967
17:45	85	219	304	97	9	101	207	252	5	131	388	899
Total Volume	447	982	1429	373	44	399	816	1037	25	508	1570	3815
% App. Total	31.3	68.7		45.7	5.4	48.9		66.1	1.6	32.4		
PHF	.798	.913	.933	.961	.611	.831	.915	.929	.625	.920	.935	.963
Passenger Vehicles	437	971	1408	369	44	386	799	1013	25	503	1541	3748
% Passenger Vehicles	97.8	98.9	98.5	98.9	100	96.7	97.9	97.7	100	99.0	98.2	98.2
Heavy Vehicles	10	11	21	4	0	13	17	24	0	5	29	67
% Heavy Vehicles	2.2	1.1	1.5	1.1	0	3.3	2.1	2.3	0	1.0	1.8	1.8

3.1

1.1

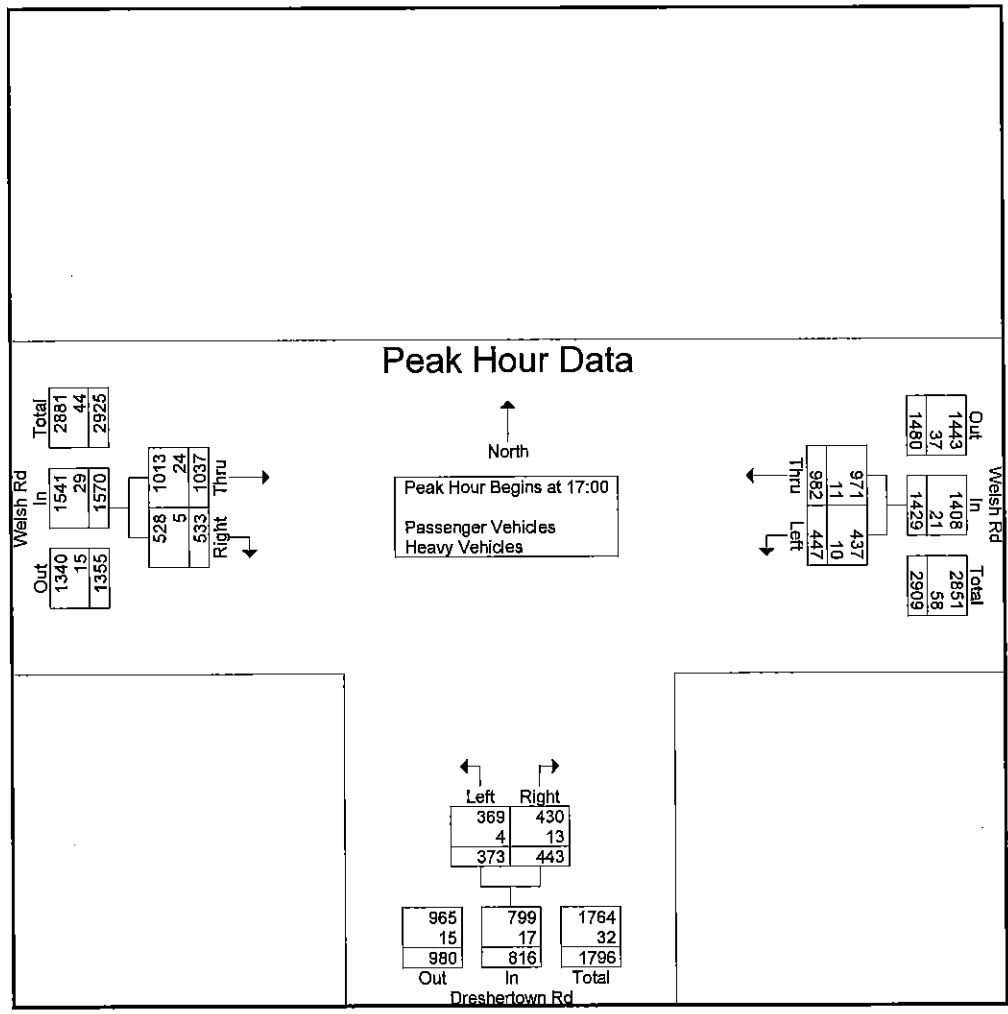

McMahon Associates, Inc.

425 Commerce Drive, Suite 200
Fort Washington, P A 19034

Municipality: Upper Dublin Township
Location: Welsh Road &
Dreshertown Road
Counter/Board #: LB

File Name : dryden02wR
Site Code : 81536702
Start Date : 12/3/2015
Page No : 1

Groups Printed- Passenger Vehicles

Start Time	Welsh Rd Westbound		Dreshertown Rd Northbound			Welsh Rd Eastbound			Int. Total
	Left	Thru	Left	ROR	Right	Thru	ROR	Right	
07:00	76	155	29	16	21	156	10	98	561
07:15	96	159	47	25	50	130	11	101	619
07:30	105	212	55	23	65	236	15	98	809
07:45	81	228	67	28	73	202	14	92	785
Total	358	754	198	92	209	724	50	389	2774
08:00	112	222	60	16	78	188	8	114	798
08:15	96	210	60	14	64	196	6	126	772
08:30	89	155	45	24	58	215	11	108	705
08:45	81	152	56	6	58	161	4	113	631
Total	378	739	221	60	258	760	29	461	2906
16:00	93	197	59	27	40	171	13	106	706
16:15	75	194	49	12	51	179	8	91	659
16:30	84	199	72	22	74	174	14	98	737
16:45	81	186	74	13	62	187	8	110	721
Total	333	776	254	74	227	711	43	405	2823
17:00	110	266	94	18	84	238	10	126	946
17:15	137	241	89	12	119	260	7	111	976
17:30	107	249	89	5	88	270	3	135	946
17:45	83	215	97	9	95	245	5	131	880
Total	437	971	369	44	386	1013	25	503	3748
Grand Total	1506	3240	1042	270	1080	3208	147	1758	12251
Apprch %	31.7	68.3	43.6	11.3	45.2	62.7	2.9	34.4	
Total %	12.3	26.4	8.5	2.2	8.8	26.2	1.2	14.3	

McMahon Associates, Inc.

425 Commerce Drive, Suite 200
Fort Washington, P A 19034

Municipality: Upper Dublin Township
Location: Welsh Road &
Dreshertown Road
Counter/Board #: LB

File Name : dryden02wR
Site Code : 81536702
Start Date : 12/3/2015
Page No : 1

Groups Printed- Heavy Vehicles

Start Time	Welsh Rd Westbound		Dreshertown Rd Northbound			Welsh Rd Eastbound			Int. Total
	Left	Thru	Left	ROR	Right	Thru	ROR	Right	
07:00	1	2	1	0	2	2	0	3	11
07:15	1	4	2	0	1	1	0	3	12
07:30	2	8	3	0	1	2	0	1	17
07:45	3	7	2	0	5	3	0	4	24
Total	7	21	8	0	9	8	0	11	64
08:00	3	4	2	0	3	4	0	3	19
08:15	2	9	3	0	3	2	0	6	25
08:30	3	7	1	0	2	5	0	4	22
08:45	0	3	1	0	2	3	0	0	9
Total	8	23	7	0	10	14	0	13	75
16:00	1	3	2	0	3	5	0	0	14
16:15	4	4	5	0	6	1	0	2	22
16:30	3	5	0	0	5	3	0	2	18
16:45	3	1	0	0	6	4	0	0	14
Total	11	13	7	0	20	13	0	4	68
17:00	3	3	2	0	1	3	0	1	13
17:15	3	2	2	0	1	5	0	1	14
17:30	2	2	0	0	5	9	0	3	21
17:45	2	4	0	0	6	7	0	0	19
Total	10	11	4	0	13	24	0	5	67
Grand Total	36	68	26	0	52	59	0	33	274
Apprch %	34.6	65.4	33.3	0	66.7	64.1	0	35.9	
Total %	13.1	24.8	9.5	0	19	21.5	0	12	

McMahon Associates, Inc.

425 Commerce Drive, Suite 200
Fort Washington, P A 19034

Municipality: Upper Dublin
Location: Welsh Rd (Rt 63) &
Dreshertown Road
Counter/Board #: KB

File Name : pru02s
Site Code : 81600002
Start Date : 1/9/2015
Page No : 1

Groups Printed- Passenger Vehicles - Heavy Vehicles

Start Time	Welsh Rd (Rt 63) Westbound		Dreshertown Rd Northbound			Welsh Rd (Rt 63) Eastbound			Int. Total
	Left	Thru	Left	ROR	Right	Thru	ROR	Right	
11:00	46	157	25	32	24	153	8	30	475
11:15	38	173	21	31	38	177	7	33	518
11:30	47	181	27	26	33	189	4	33	540
11:45	53	175	24	14	54	201	3	28	552
Total	184	686	97	103	149	720	22	124	2085
12:00	51	177	33	30	38	188	2	42	561
12:15	61	171	47	17	48	186	0	34	564
12:30	55	217	36	24	64	220	0	46	662
12:45	60	183	39	17	51	211	0	42	603
Total	227	748	155	88	201	805	2	164	2390
13:00	64	190	29	20	50	200	0	35	588
13:15	50	192	28	12	35	184	0	28	529
13:30	66	203	30	14	52	192	0	23	580
13:45	71	191	23	0	51	171	0	18	525
Total	251	776	110	46	188	747	0	104	2222
Grand Total	662	2210	362	237	538	2272	24	392	6697
Apprch %	23.1	76.9	31.8	20.8	47.3	84.5	0.9	14.6	
Total %	9.9	33	5.4	3.5	8	33.9	0.4	5.9	
Passenger Vehicles	659	2201	360	237	538	2268	24	389	6676
% Passenger Vehicles	99.5	99.6	99.4	100	100	99.8	100	99.2	99.7
Heavy Vehicles	3	9	2	0	0	4	0	3	21
% Heavy Vehicles	0.5	0.4	0.6	0	0	0.2	0	0.8	0.3

McMahon Associates, Inc.

425 Commerce Drive, Suite 200
Fort Washington, P A 19034

Municipality: Upper Dublin
Location: Welsh Rd (Rt 63) &
Dreshertown Road
Counter/Board #: KB

File Name : pruo2s
Site Code : 81600002
Start Date : 1/9/2015
Page No : 2

Start Time	Welsh Rd (Rt 63) Westbound			Dreshertown Rd Northbound				Welsh Rd (Rt 63) Eastbound				Int. Total
	Left	Thru	App. Total	Left	ROR	Right	App. Total	Thru	ROR	Right	App. Total	
Peak Hour Analysis From 11:00 to 13:30 - Peak 1 of 1												
Peak Hour for Entire Intersection Begins at 12:15												
12:15	61	171	232	47	17	48	112	186	0	34	220	564
12:30	55	217	272	36	24	64	124	220	0	46	266	662
12:45	60	183	243	39	17	51	107	211	0	42	253	603
13:00	64	190	254	29	20	50	99	200	0	35	235	588
Total Volume	240	761	1001	151	78	213	442	817	0	157	974	2417
% App. Total	24	76		34.2	17.6	48.2		83.9	0	16.1		
PHF	.938	.877	.920	.803	.813	.832	.891	.928	.000	.853	.915	.913
Passenger Vehicles	240	758	998	151	78	213	442	815	0	155	970	2410
% Passenger Vehicles	100	99.6	99.7	100	100	100	100	99.8	0	98.7	99.6	99.7
Heavy Vehicles	0	3	3	0	0	0	0	2	0	2	4	7
% Heavy Vehicles	0	0.4	0.3	0	0	0	0	0.2	0	1.3	0.4	0.3

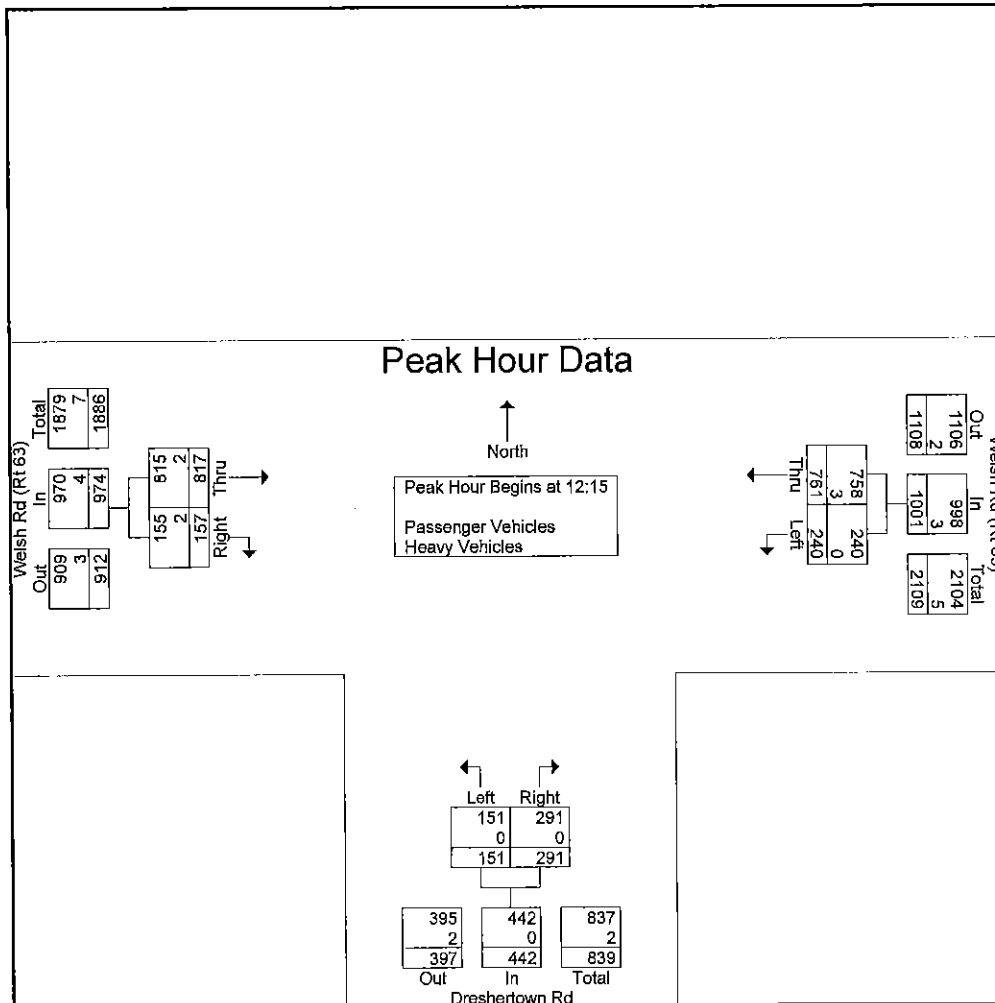

McMahon Associates, Inc.

425 Commerce Drive, Suite 200
Fort Washington, P A 19034

Municipality: Upper Dublin
Location: Welsh Rd (Rt 63) &
Dreshertown Road
Counter/Board #: KB

File Name : pru02s
Site Code : 81600002
Start Date : 1/9/2015
Page No : 1

Groups Printed- Passenger Vehicles

Start Time	Welsh Rd (Rt 63) Westbound		Dreshertown Rd Northbound			Welsh Rd (Rt 63) Eastbound			Int. Total
	Left	Thru	Left	ROR	Right	Thru	ROR	Right	
11:00	46	157	25	32	24	153	8	30	475
11:15	37	170	20	31	38	176	7	33	512
11:30	46	181	27	26	33	189	4	32	538
11:45	53	173	23	14	54	201	3	28	549
Total	182	681	95	103	149	719	22	123	2074
12:00	51	176	33	30	38	188	2	42	560
12:15	61	170	47	17	48	185	0	34	562
12:30	55	215	36	24	64	220	0	46	660
12:45	60	183	39	17	51	210	0	41	601
Total	227	744	155	88	201	803	2	163	2383
13:00	64	190	29	20	50	200	0	34	587
13:15	49	192	28	12	35	184	0	28	528
13:30	66	203	30	14	52	191	0	23	579
13:45	71	191	23	0	51	171	0	18	525
Total	250	776	110	46	188	746	0	103	2219
Grand Total	659	2201	360	237	538	2268	24	389	6676
Apprch %	23	77	31.7	20.9	47.4	84.6	0.9	14.5	
Total %	9.9	33	5.4	3.6	8.1	34	0.4	5.8	

McMahon Associates, Inc.

425 Commerce Drive, Suite 200
Fort Washington, P A 19034

Municipality: Upper Dublin
Location: Welsh Rd (Rt 63) &
Dreshertown Road
Counter/Board #: KB

File Name : pru02s
Site Code : 81600002
Start Date : 1/9/2015
Page No : 1

Groups Printed- Heavy Vehicles

Start Time	Welsh Rd (Rt 63) Westbound		Dreshertown Rd Northbound			Welsh Rd (Rt 63) Eastbound			Int. Total
	Left	Thru	Left	ROR	Right	Thru	ROR	Right	
11:15	1	3	1	0	0	1	0	0	6
11:30	1	0	0	0	0	0	0	1	2
11:45	0	2	1	0	0	0	0	0	3
Total	2	5	2	0	0	1	0	1	11
12:00	0	1	0	0	0	0	0	0	1
12:15	0	1	0	0	0	1	0	0	2
12:30	0	2	0	0	0	0	0	0	2
12:45	0	0	0	0	0	1	0	1	2
Total	0	4	0	0	0	2	0	1	7
13:00	0	0	0	0	0	0	0	1	1
13:15	1	0	0	0	0	0	0	0	1
13:30	0	0	0	0	0	1	0	0	1
Total	1	0	0	0	0	1	0	1	3
Grand Total	3	9	2	0	0	4	0	3	21
Apprch %	25	75	100	0	0	57.1	0	42.9	
Total %	14.3	42.9	9.5	0	0	19	0	14.3	

McMahon Associates, Inc.

425 Commerce Drive, Suite 200
Fort Washington, P A 19034

Municipality: Upper Dublin Township
Location: Welsh Road &
Dryden Road
Counter/Board #: GG

File Name : dryden01wR
Site Code : 81536701
Start Date : 12/3/2015
Page No : 1

Groups Printed- Passenger Vehicles - Heavy Vehicles

Start Time	Dryden Rd Southbound				Welsh Rd Westbound				Dryden Rd Northbound				Welsh Rd Eastbound				Int. Total
	Left	Thru	ROR	Right	Left	Thru	ROR	Right	Left	Thru	ROR	Right	Left	Thru	ROR	Right	
07:00	0	0	0	0	1	286	0	0	1	0	0	0	0	202	0	4	494
07:15	0	0	0	0	7	319	0	0	0	0	0	0	0	229	0	11	566
07:30	0	0	0	0	6	356	0	0	0	0	0	0	0	293	2	11	668
07:45	1	0	0	0	6	354	0	0	1	0	0	0	0	305	0	18	685
Total	1	0	0	0	20	1315	0	0	2	0	0	0	0	1029	2	44	2413
08:00	0	0	0	0	16	371	0	1	0	0	0	0	0	265	0	35	688
08:15	1	0	0	0	29	364	0	0	1	0	0	0	1	323	0	30	749
08:30	0	0	0	1	21	324	0	0	2	1	0	0	1	270	1	41	662
08:45	0	0	0	0	14	316	0	0	2	0	0	0	0	275	0	19	626
Total	1	0	0	1	80	1375	0	1	5	1	0	0	2	1133	1	125	2725
16:00	1	0	0	0	0	322	0	0	7	0	0	1	0	299	0	1	631
16:15	0	0	0	1	1	272	0	0	6	0	0	4	0	306	0	2	592
16:30	1	0	0	0	4	315	0	0	20	0	0	0	0	332	0	0	672
16:45	1	0	0	0	0	371	0	0	7	0	0	3	0	340	0	0	722
Total	3	0	0	1	5	1280	0	0	40	0	0	8	0	1277	0	3	2617
17:00	0	0	0	1	0	353	0	0	25	8	0	3	0	381	0	2	773
17:15	1	0	0	0	0	328	0	0	35	0	0	2	0	417	0	2	785
17:30	1	0	0	0	0	317	0	0	28	0	0	1	0	419	0	1	767
17:45	0	0	0	0	3	285	0	0	39	0	0	4	0	365	1	0	697
Total	2	0	0	1	3	1283	0	0	127	8	0	10	0	1582	1	5	3022
Grand Total	7	0	0	3	108	5253	0	1	174	9	0	18	2	5021	4	177	10777
Apprch %	70	0	0	30	2	98	0	0	86.6	4.5	0	9	0	96.5	0.1	3.4	
Total %	0.1	0	0	0	1	48.7	0	0	1.6	0.1	0	0.2	0	46.6	0	1.6	
Passenger Vehicles	7	0	0	3	107	5181	0	1	172	8	0	18	2	4957	4	177	10637
% Passenger Vehicles	100	0	0	100	99.1	98.6	0	100	98.9	88.9	0	100	100	98.7	100	100	98.7
Heavy Vehicles	0	0	0	0	1	72	0	0	2	1	0	0	0	64	0	0	140
% Heavy Vehicles	0	0	0	0	0.9	1.4	0	0	1.1	11.1	0	0	0	1.3	0	0	1.3

McMahon Associates, Inc.

425 Commerce Drive, Suite 200
Fort Washington, P A 19034

Municipality: Upper Dublin Township
Location: Welsh Road &
Dryden Road
Counter/Board #: GG

File Name : dryden01wR
Site Code : 81536701
Start Date : 12/3/2015
Page No : 2

Start Time	Dryden Rd Southbound					Welsh Rd Westbound					Dryden Rd Northbound					Welsh Rd Eastbound					Int. Total					
	Left	Thru	ROR	Right	App. Total	Left	Thru	ROR	Right	App. Total	Left	Thru	ROR	Right	App. Total	Left	Thru	ROR	Right	App. Total						
Peak Hour Analysis From 07:00 to 11:45 - Peak 1 of 1																										
Peak Hour for Entire Intersection Begins at 07:30																										
07:30	0	0	0	0	0	6	356	0	0	362	0	0	0	0	0	0	293	2	11	306	668					
07:45	1	0	0	0	1	6	354	0	0	360	1	0	0	0	1	0	305	0	18	323	685					
08:00	0	0	0	0	0	16	371	0	1	388	0	0	0	0	0	0	265	0	35	300	688					
08:15	1	0	0	0	1	29	364	0	0	393	1	0	0	0	1	1	323	0	30	354	749					
Total Volume	2	0	0	0	2	57	1445	0	1	1503	2	0	0	0	2	1	1186	2	94	1283	2790					
% App. Total	100	0	0	0	0	3.8	96.1	0	0.1	100	100	0	0	0	0	0.1	92.4	0.2	7.3	100	100					
PHF	.500	.000	.000	.000	.500	.491	.974	.000	.250	.956	.500	.000	.000	.000	.500	.250	.918	.250	.671	.906	.931					
Passenger Vehicles						1420										1169										
% Passenger Vehicles	100	0	0	0	100	98.2	98.3	0	100	98.3	100	0	0	0	100	100	98.6	100	100	98.7	98.5					
Heavy Vehicles						1.8					1.7										1.3					1.5
% Heavy Vehicles	0	0	0	0	0	1.8	1.7	0	0	1.7	0	0	0	0	0	0	1.4	0	0	1.3	1.5					

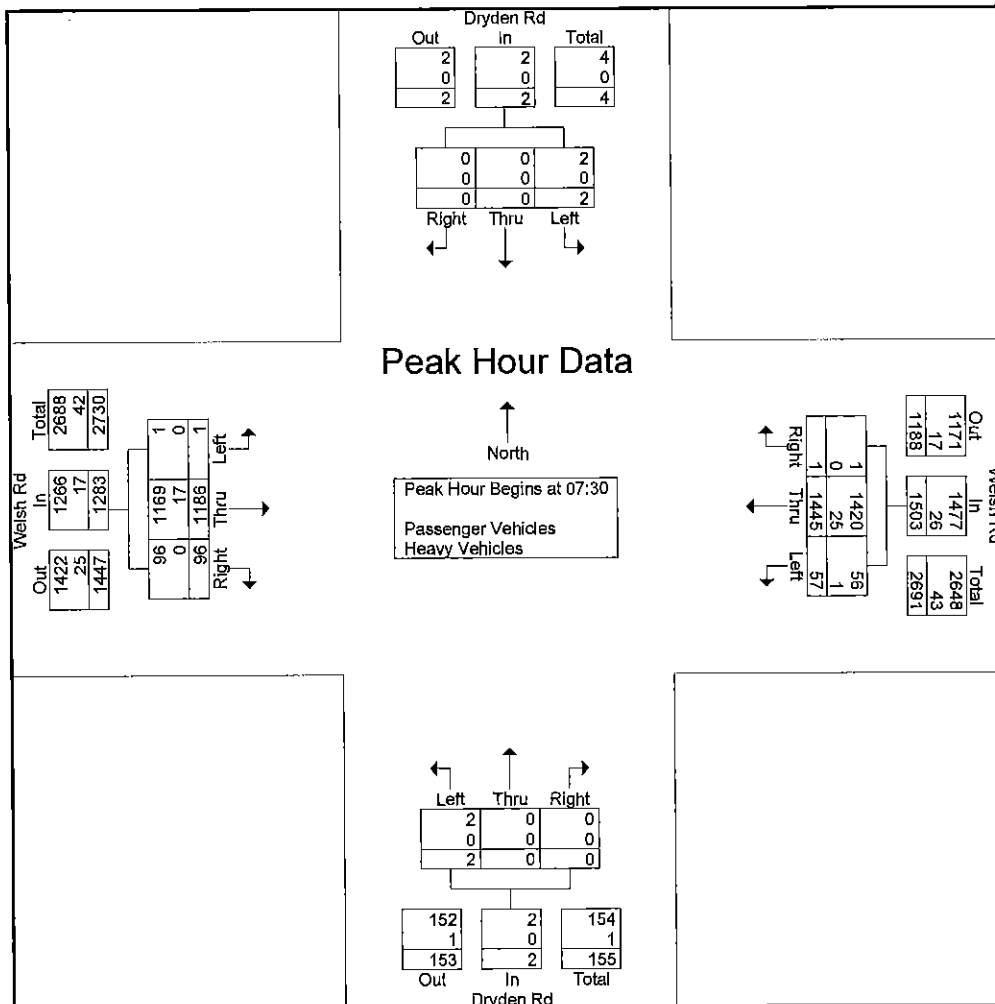

Peak Hour Begins at 07:30
Passenger Vehicles
Heavy Vehicles

McMahon Associates, Inc.

425 Commerce Drive, Suite 200
Fort Washington, P A 19034

Municipality: Upper Dublin Township
Location: Welsh Road &
Dryden Road
Counter/Board #: GG

File Name : dryden01wR
Site Code : 81536701
Start Date : 12/3/2015
Page No : 3

Start Time	Dryden Rd Southbound					Welsh Rd Westbound					Dryden Rd Northbound					Welsh Rd Eastbound					Int. Total
	Left	Thru	ROR	Right	App. Total	Left	Thru	ROR	Right	App. Total	Left	Thru	ROR	Right	App. Total	Left	Thru	ROR	Right	App. Total	
Peak Hour Analysis From 12:00 to 17:45 - Peak 1 of 1																					
Peak Hour for Entire Intersection Begins at 16:45																					
16:45	1	0	0	0	1	0	371	0	0	371	7	0	0	3	10	0	340	0	0	340	722
17:00	0	0	0	1	1	0	353	0	0	353	25	8	0	3	36	0	381	0	2	383	773
17:15	1	0	0	0	1	0	328	0	0	328	35	0	0	2	37	0	417	0	2	419	785
17:30	1	0	0	0	1	0	317	0	0	317	28	0	0	1	29	0	419	0	1	420	767
Total Volume	3	0	0	1	4	0	1369	0	0	1369	95	8	0	9	112	0	1557	0	5	1562	3047
% App. Total	75	0	0	25		0	100	0	0		84.8	7.1	0	8		0	99.7	0	0.3		
PHF	.750	.000	.000	.250	1.00	.000	.923	.000	.000	.923	.679	.250	.000	.750	.757	.000	.929	.000	.625	.930	.970
Passenger Vehicles						1349										1540					
% Passenger Vehicles	100	0	0	100	100	0	98.5	0	0	98.5	100	100	0	100	100	0	98.9	0	100	98.9	98.8
Heavy Vehicles						0					0					0					
% Heavy Vehicles	0	0	0	0	0	0	1.5	0	0	1.5	0	0	0	0	0	0	1.1	0	0	1.1	1.2

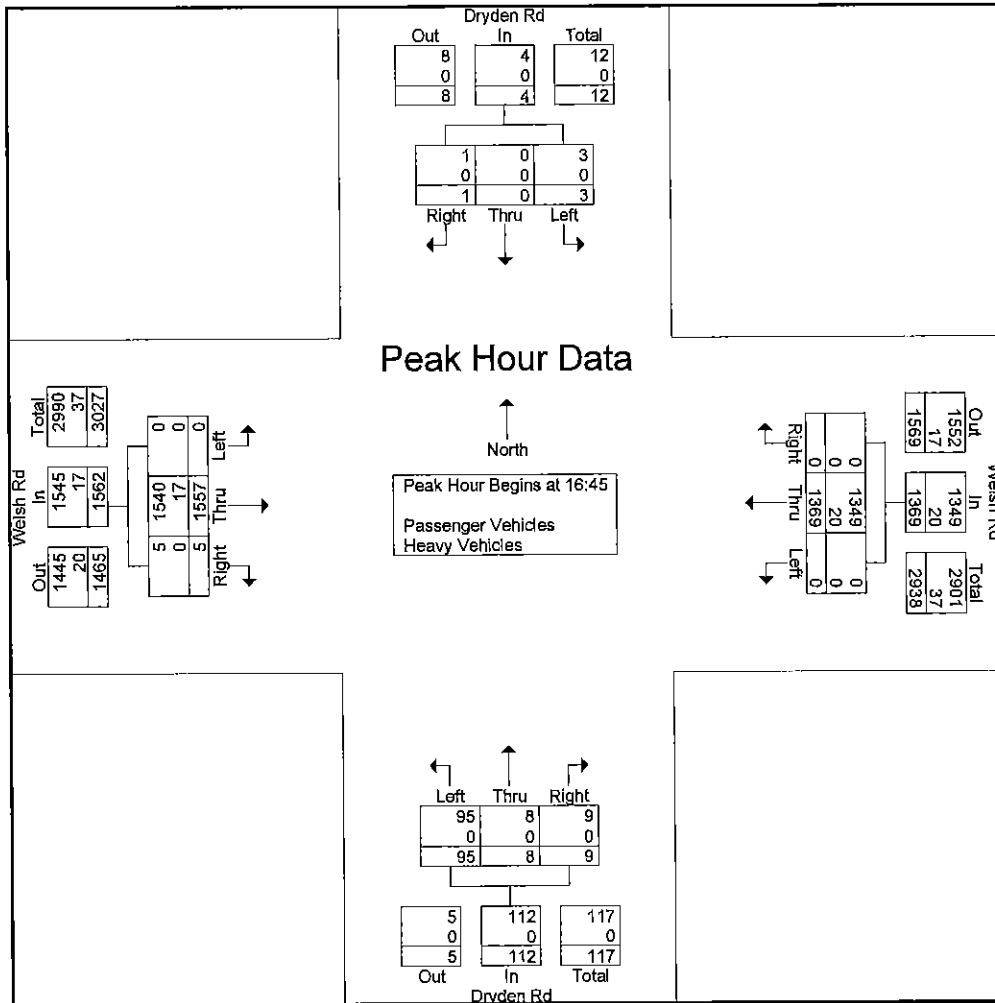

McMahon Associates, Inc.

425 Commerce Drive, Suite 200
Fort Washington, P A 19034

Municipality: Upper Dublin Township
Location: Welsh Road &
Dryden Road
Counter/Board #: GG

File Name : dryden01wR
Site Code : 81536701
Start Date : 12/3/2015
Page No : 1

Groups Printed- Passenger Vehicles

Start Time	Dryden Rd Southbound				Welsh Rd Westbound				Dryden Rd Northbound				Welsh Rd Eastbound				Int Total
	Left	Thru	ROR	Right	Left	Thru	ROR	Right	Left	Thru	ROR	Right	Left	Thru	ROR	Right	
07:00	0	0	0	0	1	284	0	0	1	0	0	0	0	201	0	4	491
07:15	0	0	0	0	7	316	0	0	0	0	0	0	0	226	0	11	560
07:30	0	0	0	0	6	350	0	0	0	0	0	0	0	287	2	11	656
07:45	1	0	0	0	6	346	0	0	1	0	0	0	0	301	0	18	673
Total	1	0	0	0	20	1296	0	0	2	0	0	0	0	1015	2	44	2380
08:00	0	0	0	0	16	366	0	1	0	0	0	0	0	260	0	35	678
08:15	1	0	0	0	28	358	0	0	1	0	0	0	1	321	0	30	740
08:30	0	0	0	1	21	319	0	0	1	0	0	0	1	269	1	41	654
08:45	0	0	0	0	14	312	0	0	1	0	0	0	0	266	0	19	612
Total	1	0	0	1	79	1355	0	1	3	0	0	0	2	1116	1	125	2684
16:00	1	0	0	0	0	320	0	0	7	0	0	1	0	292	0	1	622
16:15	0	0	0	1	1	268	0	0	6	0	0	4	0	303	0	2	585
16:30	1	0	0	0	4	311	0	0	20	0	0	0	0	328	0	0	664
16:45	1	0	0	0	0	362	0	0	7	0	0	3	0	336	0	0	709
Total	3	0	0	1	5	1261	0	0	40	0	0	8	0	1259	0	3	2580
17:00	0	0	0	1	0	347	0	0	25	8	0	3	0	381	0	2	767
17:15	1	0	0	0	0	327	0	0	35	0	0	2	0	413	0	2	780
17:30	1	0	0	0	0	313	0	0	28	0	0	1	0	410	0	1	754
17:45	0	0	0	0	3	282	0	0	39	0	0	4	0	363	1	0	692
Total	2	0	0	1	3	1269	0	0	127	8	0	10	0	1567	1	5	2993
Grand Total	7	0	0	3	107	5181	0	1	172	8	0	18	2	4957	4	177	10637
Apprch %	70	0	0	30	2	98	0	0	86.9	4	0	9.1	0	96.4	0.1	3.4	
Total %	0.1	0	0	0	1	48.7	0	0	1.6	0.1	0	0.2	0	46.6	0	1.7	

McMahon Associates, Inc.

425 Commerce Drive, Suite 200
Fort Washington, P A 19034

Municipality: Upper Dublin Township
Location: Welsh Road &
Dryden Road
Counter/Board #: GG

File Name : dryden01wR
Site Code : 81536701
Start Date : 12/3/2015
Page No : 1

Groups Printed- Heavy Vehicles

Start Time	Dryden Rd Southbound				Welsh Rd Westbound				Dryden Rd Northbound				Welsh Rd Eastbound				Int. Total
	Left	Thru	ROR	Right	Left	Thru	ROR	Right	Left	Thru	ROR	Right	Left	Thru	ROR	Right	
07:00	0	0	0	0	0	2	0	0	0	0	0	0	0	1	0	0	3
07:15	0	0	0	0	0	3	0	0	0	0	0	0	0	3	0	0	6
07:30	0	0	0	0	0	6	0	0	0	0	0	0	0	6	0	0	12
07:45	0	0	0	0	0	8	0	0	0	0	0	0	0	4	0	0	12
Total	0	0	0	0	0	19	0	0	0	0	0	0	0	14	0	0	33
08:00	0	0	0	0	0	5	0	0	0	0	0	0	0	5	0	0	10
08:15	0	0	0	0	1	6	0	0	0	0	0	0	0	2	0	0	9
08:30	0	0	0	0	0	5	0	0	1	1	0	0	0	1	0	0	8
08:45	0	0	0	0	0	4	0	0	1	0	0	0	0	9	0	0	14
Total	0	0	0	0	1	20	0	0	2	1	0	0	0	17	0	0	41
16:00	0	0	0	0	0	2	0	0	0	0	0	0	0	7	0	0	9
16:15	0	0	0	0	0	4	0	0	0	0	0	0	0	3	0	0	7
16:30	0	0	0	0	0	4	0	0	0	0	0	0	0	4	0	0	8
16:45	0	0	0	0	0	9	0	0	0	0	0	0	0	4	0	0	13
Total	0	0	0	0	0	19	0	0	0	0	0	0	0	18	0	0	37
17:00	0	0	0	0	0	6	0	0	0	0	0	0	0	0	0	0	6
17:15	0	0	0	0	0	1	0	0	0	0	0	0	0	4	0	0	5
17:30	0	0	0	0	0	4	0	0	0	0	0	0	0	9	0	0	13
17:45	0	0	0	0	0	3	0	0	0	0	0	0	0	2	0	0	5
Total	0	0	0	0	0	14	0	0	0	0	0	0	0	15	0	0	29
Grand Total	0	0	0	0	1	72	0	0	2	1	0	0	0	64	0	0	140
Apprch %	0	0	0	0	1.4	98.6	0	0	66.7	33.3	0	0	0	100	0	0	
Total %	0	0	0	0	0.7	51.4	0	0	1.4	0.7	0	0	0	45.7	0	0	

McMahon Associates, Inc.

425 Commerce Drive, Suite 200
Fort Washington, P A 19034

Municipality: Upper Dublin
Location: Welsh Road (Route 63)
& Dryden Road
Counter/Board #: AB

File Name : pru01s
Site Code : 81600001
Start Date : 1/9/2016
Page No : 1

Groups Printed- Passenger Vehicles - Heavy Vehicles

Start Time	Dryden Rd Southbound			Welsh Rd (Rt 63) Westbound			Dryden Rd Northbound			Welsh Rd (Rt 63) Eastbound			Int. Total
	Left	Thru	Right	Left	Thru	Right	Left	Thru	Right	Left	Thru	Right	
11:00	0	0	0	0	197	0	0	0	0	0	237	0	434
11:15	0	0	0	0	221	0	0	0	0	0	248	0	469
11:30	0	0	0	0	248	0	0	0	1	0	242	1	492
11:45	0	0	1	2	225	1	0	0	1	0	263	0	493
Total	0	0	1	2	891	1	0	0	2	0	990	1	1888
12:00	1	0	1	0	226	1	0	0	2	1	252	2	486
12:15	1	0	1	2	223	1	1	0	0	1	247	0	477
12:30	1	0	1	1	262	2	0	0	1	0	295	0	563
12:45	0	0	0	0	231	0	1	0	0	0	267	1	500
Total	3	0	3	3	942	4	2	0	3	2	1061	3	2026
13:00	0	0	0	0	257	1	0	0	1	0	264	1	524
13:15	1	0	2	0	228	0	0	0	0	2	241	0	474
13:30	1	0	0	1	311	1	0	0	0	0	262	1	577
13:45	2	0	0	2	252	2	0	0	1	1	216	2	478
Total	4	0	2	3	1048	4	0	0	2	3	983	4	2053
Grand Total	7	0	6	8	2881	9	2	0	7	5	3034	8	5967
Apprch %	53.8	0	46.2	0.3	99.4	0.3	22.2	0	77.8	0.2	99.6	0.3	
Total %	0.1	0	0.1	0.1	48.3	0.2	0	0	0.1	0.1	50.8	0.1	
Passenger Vehicles	7	0	6	8	2878	9	2	0	7	5	3032	8	5962
% Passenger Vehicles	100	0	100	100	99.9	100	100	0	100	100	99.9	100	99.9
Heavy Vehicles	0	0	0	0	3	0	0	0	0	0	2	0	5
% Heavy Vehicles	0	0	0	0	0.1	0	0	0	0	0	0.1	0	0.1

McMahon Associates, Inc.

425 Commerce Drive, Suite 200
Fort Washington, P A 19034

Municipality: Upper Dublin
Location: Welsh Road (Route 63)
& Dryden Road
Counter/Board #: AB

File Name : pr01s
Site Code : 81600001
Start Date : 1/9/2016
Page No : 2

Start Time	Dryden Rd Southbound				Welsh Rd (Rt 63) Westbound				Dryden Rd Northbound				Welsh Rd (Rt 63) Eastbound				Inl. Total
	Left	Thru	Right	App. Total	Left	Thru	Right	App. Total	Left	Thru	Right	App. Total	Left	Thru	Right	App. Total	
Peak Hour Analysis From 11:00 to 13:45 - Peak 1 of 1																	
Peak Hour for Entire Intersection Begins at 12:45																	
12:45	0	0	0	0	0	231	0	231	1	0	0	1	0	267	1	268	500
13:00	0	0	0	0	0	257	1	258	0	0	1	1	0	264	1	265	524
13:15	1	0	2	3	0	228	0	228	0	0	0	0	2	241	0	243	474
13:30	1	0	0	1	1	311	1	313	0	0	0	0	0	262	1	263	577
Total Volume	2	0	2	4	1	1027	2	1030	1	0	1	2	2	1034	3	1039	2075
% App. Total	50	0	50		0.1	99.7	0.2		50	0	50		0.2	99.5	0.3		
PHF	.500	.000	.250	.333	.250	.826	.500	.823	.250	.000	.250	.500	.250	.968	.750	.969	.899
Passenger Vehicles	2	0	2	4	1	1027	2	1030	1	0	1	2	2	1034	3	1039	2075
% Passenger Vehicles	100	0	100	100	100	100	100	100	100	0	100	100	100	100	100	100	100
Heavy Vehicles	0	0	0	0	0	0	0	0	0	0	0	0	0	0	0	0	0
% Heavy Vehicles	0	0	0	0	0	0	0	0	0	0	0	0	0	0	0	0	0

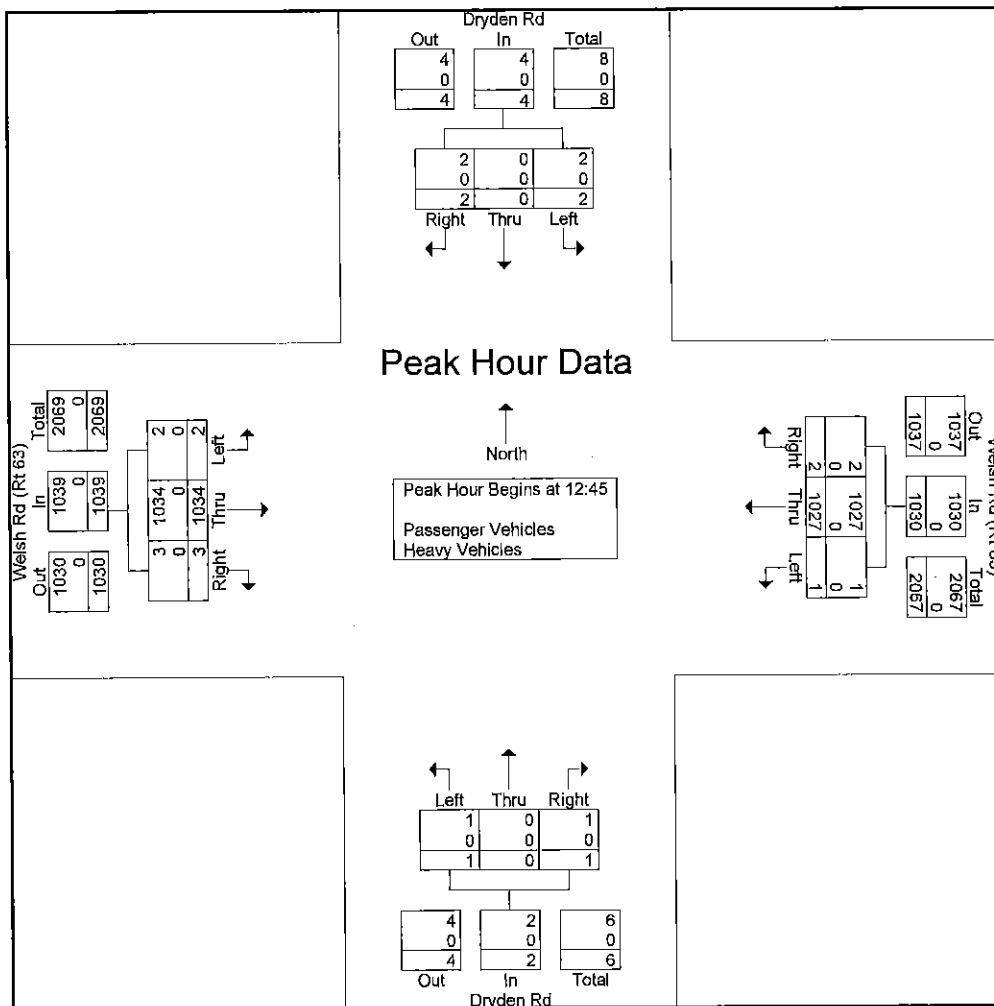

McMahon Associates, Inc.

425 Commerce Drive, Suite 200
Fort Washington, P A 19034

Municipality: Upper Dublin
Location: Welsh Road (Route 63)
& Dryden Road
Counter/Board #: AB

File Name : pru01s
Site Code : 81600001
Start Date : 1/9/2016
Page No : 1

Groups Printed- Passenger Vehicles

Start Time	Dryden Rd Southbound			Welsh Rd (Rt 63) Westbound			Dryden Rd Northbound			Welsh Rd (Rt 63) Eastbound			Int. Total
	Left	Thru	Right	Left	Thru	Right	Left	Thru	Right	Left	Thru	Right	
11:00	0	0	0	0	196	0	0	0	0	0	237	0	433
11:15	0	0	0	0	220	0	0	0	0	0	248	0	468
11:30	0	0	0	0	248	0	0	0	0	1	242	1	492
11:45	0	0	1	2	224	1	0	0	1	0	263	0	492
Total	0	0	1	2	888	1	0	0	2	0	990	1	1885
12:00	1	0	1	0	226	1	0	0	2	1	252	2	486
12:15	1	0	1	2	223	1	1	0	0	1	247	0	477
12:30	1	0	1	1	262	2	0	0	1	0	293	0	561
12:45	0	0	0	0	231	0	1	0	0	0	267	1	500
Total	3	0	3	3	942	4	2	0	3	2	1059	3	2024
13:00	0	0	0	0	257	1	0	0	1	0	264	1	524
13:15	1	0	2	0	228	0	0	0	0	2	241	0	474
13:30	1	0	0	1	311	1	0	0	0	0	262	1	577
13:45	2	0	0	2	252	2	0	0	1	1	216	2	478
Total	4	0	2	3	1048	4	0	0	2	3	983	4	2053
Grand Total	7	0	6	8	2878	9	2	0	7	5	3032	8	5962
Apprch %	53.8	0	46.2	0.3	99.4	0.3	22.2	0	77.8	0.2	99.6	0.3	
Total %	0.1	0	0.1	0.1	48.3	0.2	0	0	0.1	0.1	50.9	0.1	

McMahon Associates, Inc.

425 Commerce Drive, Suite 200
Fort Washington, P A 19034

Municipality: Upper Dublin
Location: Welsh Road (Route 63)
& Dryden Road
Counter/Board #: AB

File Name : pru01s
Site Code : 81600001
Start Date : 1/9/2016
Page No : 1

Groups Printed- Heavy Vehicles

Start Time	Dryden Rd Southbound			Welsh Rd (Rt 63) Westbound			Dryden Rd Northbound			Welsh Rd (Rt 63) Eastbound			Int. Total
	Left	Thru	Right	Left	Thru	Right	Left	Thru	Right	Left	Thru	Right	
11:00	0	0	0	0	1	0	0	0	0	0	0	0	1
11:15	0	0	0	0	1	0	0	0	0	0	0	0	1
11:45	0	0	0	0	1	0	0	0	0	0	0	0	1
Total	0	0	0	0	3	0	0	0	0	0	0	0	3
12:30	0	0	0	0	0	0	0	0	0	0	2	0	2
Total	0	0	0	0	0	0	0	0	0	0	2	0	2
Grand Total	0	0	0	0	3	0	0	0	0	0	2	0	5
Apprch %	0	0	0	0	100	0	0	0	0	0	100	0	
Total %	0	0	0	0	60	0	0	0	0	0	40	0	

APPENDIX D

HCM Methodology

CAPACITY/LEVEL-OF-SERVICE ANALYSIS METHODOLOGY

The detailed capacity/level-of-service analysis contained in this transportation impact study was performed in accordance with the standard techniques contained in the *Highway Capacity Manual 2010*. By definition, capacity represents "the maximum sustainable hourly flow rate at which persons or vehicles reasonably can be expected to traverse a point or a uniform section of a lane or roadway during a given time period under prevailing roadway, environmental, traffic, and control conditions." The level at which an intersection or a uniform section of a lane or roadway function can be expressed in terms of a level of service. Level of service (LOS) is defined as "a quantitative stratification of a performance measure or measures that represent quality of service, measured on an A-F scale, with LOS A representing the best operating conditions from the traveler's perspective and LOS F the worst."

Stop-Controlled Intersections

At unsignalized stop-controlled intersections, such as two-way stop-controlled (TWSC) or all-way stop-controlled (AWSC), a methodology for evaluating the relative functioning of these intersections is based upon the control delay. For these types of unsignalized intersections, the analysis of the control delay is based upon the following data:

- Number and configuration of lanes on each approach;
- Percentage of heavy vehicles on each approach;
- Demand flow rate for each entering vehicular movement and pedestrian crossing movement;
- Unique geometric factors such as, channelization aspects; two-way left-turn lanes, raised or striped median storage; approach grades, flared approaches on the minor street; and upstream signals within 0.25 miles.

At TWSC intersections, only drivers on the minor street approaches are required to stop before proceeding into the intersection and left-turning drivers from the major street may have to yield to on-coming major street through or right-turning traffic, but are not required to stop in the absence of on-coming traffic. The capacity at stop-controlled legs is based primarily on three factors: the distribution of gaps in the major stream, driver judgment in selecting the gaps, and the follow-up headways required by each driver in a queue.

At AWSC intersections, every vehicle is required to stop at the intersection before proceeding, and as a result, the decision to proceed is a function of the traffic conditions on the other approaches. Each driver proceeds only after determining that no vehicles are currently in the intersection and that it is the driver's turn to proceed. Capacity at an AWSC intersection is described by the saturation headway or time between departures of successive vehicles on a given approach for a particular case assuming a continuous queue; departure headway or the average time between departures of successive vehicles on a given approach accounting for the probability of each possible case; and service time or the average time sent by a vehicle in first position waiting to depart.

At both TWSC and AWSC intersections, the level of service is based upon the control delay, as well as the corresponding volume-to-capacity ratio for each movement/lane group. For TWSC intersections, the level of service is not calculated for major-street approaches or for the intersection as a whole; however, the intersection-wide level of service is calculated for AWSC intersections. The following table provides a summary of the relationship between the level of service, control delay, and volume-to-capacity ratio for TWSC and AWSC intersections.

Control Delay (Sec/Veh)	LOS by Volume-to-Capacity Ratio	
	v/c ≤ 1.0	v/c > 1.0
≤ 10	A	F
> 10 – 15	B	F
> 15 – 25	C	F
> 25 – 35	D	F
> 35 – 50	E	F
> 50	F	F

Signalized Intersections

At three or four-legged signalized intersections, a methodology for evaluating the capacity and quality of service provided to road users traveling through the signalized intersection. For signalized intersections, the level of service can be characterized for the entire intersection, each approach, and each lane group. The level of service is based upon the control delay and volume-to-capacity ratio. The delay quantifies the increase in travel time due to the traffic signal control and is a surrogate measure of driver discomfort and fuel consumption, while the volume-to-capacity ratio quantifies the degree to which a phase's capacity is utilized by a lane group. Input data in determining the delay and volume-to-capacity ratio include:

- Demand flow rate for each entering vehicular movement and pedestrian crossing movement, including right-turn on red volumes and percent of heavy vehicles;
- Initial queue for each lane group;
- Number and configuration of lanes on each approach;
- Type of signal control and phase sequence;
- Allocation of minimum/maximum green times and clearance intervals (Yellow plus All Red phases); and
- Phase recall.

At signalized intersections, the level of service is based upon the control delay, as well as the corresponding volume-to-capacity ratio for each movement/lane group. The following table provides a summary of the relationship between the level of service, control delay, and volume-to-capacity ratio for signalized intersections.

Control Delay (Sec/Veh)	LOS by Volume-to-Capacity Ratio	
	v/c ≤ 1.0	v/c > 1.0
≤ 10	A	F
> 10 – 20	B	F
> 20 – 35	C	F
> 35 – 55	D	F
> 55 – 80	E	F
> 80	F	F

APPENDIX E

**Existing
Capacity/Level-of-Service Analysis Worksheets**

BT Dreshertown, LP
1: Jarrettown Road/Village Road & Welsh Road

2015 Existing AM Peak



Lane Group	EBL	EBT	EBR	WBL	WBT	WBR	NBL	NBT	NBR	SBL	SET	SBR
Lane Configurations												
Volume (vph)	55	843	14	268	642	8	10	58	309	9	19	27
Ideal Flow (vphpl)	1800	1800	1800	1800	1800	1800	1800	1800	1800	1800	1800	1800
Lane Width (ft)	12	12	12	11	14	14	12	12	12	15	15	15
Grade (%)		-6%			1%			-1%			1%	
Storage Length (ft)	150		0	100		0	0		0	0		0
Storage Lanes	1		0	1		0	0		0	0		0
Taper Length (ft)	75			75			75			75		
Lane Util. Factor	1.00	1.00	1.00	1.00	1.00	1.00	1.00	1.00	1.00	1.00	1.00	1.00
Frt		0.998			0.998			0.889			0.934	
Flt Protected	0.950			0.950				0.999			0.992	
Satd. Flow (prot)	1727	1813	0	1612	1852	0	0	1602	0	0	1736	0
Flt Permitted	0.405			0.064				0.992			0.741	
Satd. Flow (perm)	736	1813	0	109	1852	0	0	1590	0	0	1296	0
Right Turn on Red			Yes			Yes			Yes			Yes
Satd. Flow (RTOR)		1			1			175			28	
Link Speed (mph)		45			45			35			35	
Link Distance (ft)		1263			605			421			431	
Travel Time (s)		19.1			9.2			8.2			8.4	
Peak Hour Factor	0.95	0.95	0.95	0.95	0.95	0.95	0.95	0.95	0.95	0.95	0.95	0.95
Heavy Vehicles (%)	2%	2%	7%	2%	3%	0%	0%	2%	0%	11%	0%	7%
Adj. Flow (vph)	58	887	15	282	676	8	11	61	325	9	20	28
Shared Lane Traffic (%)												
Lane Group Flow (vph)	58	902	0	282	684	0	0	397	0	0	57	0
Number of Detectors	1	2		1	2		1	1		1	1	
Detector Template	Left			Left			Left	Thru		Left	Thru	
Leading Detector (ft)	5	330		35	330		20	35		20	35	
Trailing Detector (ft)	0	0		-5	0		0	-5		0	-5	
Detector 1 Position(ft)	0	0		-5	0		0	-5		0	-5	
Detector 1 Size(ft)	5	6		40	6		20	40		20	40	
Detector 1 Type	CI+Ex	CI+Ex		CI+Ex	CI+Ex		CI+Ex	CI+Ex		CI+Ex	CI+Ex	
Detector 1 Channel												
Detector 1 Extend (s)	0.0	0.0		0.0	0.0		0.0	0.0		0.0	0.0	
Detector 1 Queue (s)	0.0	0.0		0.0	0.0		0.0	0.0		0.0	0.0	
Detector 1 Delay (s)	0.0	0.0		0.0	0.0		0.0	0.0		0.0	0.0	
Detector 2 Position(ft)		324			324							
Detector 2 Size(ft)		6			6							
Detector 2 Type		CI+Ex			CI+Ex							
Detector 2 Channel												
Detector 2 Extend (s)		0.0			0.0							
Turn Type	Perm	NA		pm+pt	NA		Perm	NA		Perm	NA	
Protected Phases		2		1	6			8			4	
Permitted Phases	2			6			8			4		
Detector Phase	2	2		1	6		8	8		4	4	
Switch Phase												
Minimum Initial (s)	15.0	15.0		3.0	15.0		7.0	7.0		7.0	7.0	
Minimum Split (s)	22.0	22.0		10.0	22.0		13.0	13.0		13.0	13.0	
Total Split (s)	66.0	66.0		22.0	88.0		32.0	32.0		32.0	32.0	
Total Split (%)	55.0%	55.0%		18.3%	73.3%		26.7%	26.7%		26.7%	26.7%	

BT Dreshertown, LP
 1: Jarrettown Road/Village Road & Welsh Road

2015 Existing AM Peak



Lane Group	EBL	EBT	EBR	WBL	WBT	WBR	NBL	NBT	NBR	SBL	SBT	SBR
Maximum Green (s)	59.0	59.0		15.0	81.0		26.0	26.0		26.0	26.0	
Yellow Time (s)	5.0	5.0		5.0	5.0		4.0	4.0		4.0	4.0	
All-Red Time (s)	2.0	2.0		2.0	2.0		2.0	2.0		2.0	2.0	
Lost Time Adjust (s)	-1.0	-1.0		-1.0	-1.0			-1.0			-1.0	
Total Lost Time (s)	6.0	6.0		6.0	6.0			5.0			5.0	
Lead/Lag	Lag	Lag		Lead								
Lead-Lag Optimize?												
Vehicle Extension (s)	3.0	3.0		3.0	3.0		3.0	3.0		3.0	3.0	
Recall Mode	C-Max	C-Max		None	C-Max		None	None		None	None	

Intersection Summary

Area Type: Other
 Cycle Length: 120
 Actuated Cycle Length: 120
 Offset: 33 (28%), Referenced to phase 2:EBTL and 6:WBTL, Start of 1st Green
 Natural Cycle: 75
 Control Type: Actuated-Coordinated

Splits and Phases: 1: Jarrettown Road/Village Road & Welsh Road



BT Dreshertown, LP
1: Jarrettown Road/Village Road & Welsh Road

2015 Existing AM Peak



Movement	EBL	EBT	EBR	WBL	WBT	WBR	NEL	NBT	NBR	SEL	SBT	SBR
Lane Configurations	↖	↗		↖	↗		↕	↕		↕	↕	
Volume (veh/h)	55	843	14	268	642	8	10	58	309	9	19	27
Number	5	2	12	1	6	16	3	8	18	7	4	14
Initial Q (Qb), veh	0	0	0	0	0	0	0	0	0	0	0	0
Ped-Bike Adj(A_pbT)	1.00		1.00	1.00		1.00	1.00		1.00	1.00		1.00
Parking Bus, Adj	1.00	1.00	1.00	1.00	1.00	1.00	1.00	1.00	1.00	1.00	1.00	1.00
Adj Sat Flow, veh/h/ln	1818	1816	1854	1756	1809	1863	1809	1803	1809	1863	1771	1863
Adj Flow Rate, veh/h	58	887	13	282	676	7	11	61	298	9	20	26
Adj No. of Lanes	1	1	0	1	1	0	0	1	0	0	1	0
Peak Hour Factor	0.95	0.95	0.95	0.95	0.95	0.95	0.95	0.95	0.95	0.95	0.95	0.95
Percent Heavy Veh, %	2	2	2	2	3	3	2	2	2	0	0	0
Cap, veh/h	445	893	13	289	1221	13	36	64	285	62	129	140
Arrive On Green	0.50	0.50	0.49	0.13	0.68	0.68	0.22	0.22	0.22	0.22	0.22	0.22
Sat Flow, veh/h	778	1785	26	1672	1787	19	21	286	1267	120	572	621
Grp Volume(v), veh/h	58	0	900	282	0	683	370	0	0	55	0	0
Grp Sat Flow(s),veh/h/ln	778	0	1812	1672	0	1806	1574	0	0	1313	0	0
Q Serve(g_s), s	4.9	0.0	59.2	15.4	0.0	23.1	11.5	0.0	0.0	0.0	0.0	0.0
Cycle Q Clear(g_c), s	5.5	0.0	59.2	15.4	0.0	23.1	26.0	0.0	0.0	3.3	0.0	0.0
Prop In Lane	1.00		0.01	1.00		0.01	0.03		0.81	0.16		0.47
Lane Grp Cap(c), veh/h	445	0	906	289	0	1234	372	0	0	319	0	0
V/C Ratio(X)	0.13	0.00	0.99	0.97	0.00	0.55	1.00	0.00	0.00	0.17	0.00	0.00
Avail Cap(c_a), veh/h	445	0	906	289	0	1234	372	0	0	319	0	0
HCM Platoon Ratio	1.00	1.00	1.00	1.00	1.00	1.00	1.00	1.00	1.00	1.00	1.00	1.00
Upstream Filter(I)	1.00	0.00	1.00	1.00	0.00	1.00	1.00	0.00	0.00	1.00	0.00	0.00
Uniform Delay (d), s/veh	16.5	0.0	29.8	40.1	0.0	9.7	47.1	0.0	0.0	37.6	0.0	0.0
Incr Delay (d2), s/veh	0.6	0.0	28.4	45.7	0.0	1.8	45.3	0.0	0.0	0.3	0.0	0.0
Initial Q Delay(d3),s/veh	0.0	0.0	0.0	0.0	0.0	0.0	0.0	0.0	0.0	0.0	0.0	0.0
%ile BackOfQ(95%),veh/ln	2.0	0.0	46.6	18.9	0.0	17.7	23.8	0.0	0.0	2.7	0.0	0.0
LnGrp Delay(d),s/veh	17.2	0.0	58.2	85.8	0.0	11.5	92.4	0.0	0.0	37.8	0.0	0.0
LnGrp LOS	B		E	F		B	F			D		
Approach Vol, veh/h		958			965			370				55
Approach Delay, s/veh		55.7			33.2			92.4				37.8
Approach LOS		E			C			F				D

Timer	1	2	3	4	5	6	7	8
Assigned Phs	1	2		4		6		8
Phs Duration (G+Y+Rc), s	22.0	66.0		32.0		88.0		32.0
Change Period (Y+Rc), s	7.0	7.0		6.0		7.0		6.0
Max Green Setting (Gmax), s	15.0	59.0		26.0		81.0		26.0
Max Q Clear Time (g_c+I1), s	17.9	61.2		5.3		25.1		28.0
Green Ext Time (p_c), s	0.0	0.0		1.6		46.7		0.0

Intersection Summary	
HCM 2010 Ctrl Delay	51.8
HCM 2010 LOS	D



Lane Group	EBL	EBT	WBT	WBR	SBL	SBR
Lane Configurations		↕↕	↕↕	↗	↖↖	↗
Volume (vph)	387	803	688	568	621	278
Ideal Flow (vphpl)	1800	1800	1800	1800	1800	1800
Lane Width (ft)	12	12	11	11	12	13
Grade (%)		-1%	1%		1%	
Storage Length (ft)	0			210	0	415
Storage Lanes	0			1	2	1
Taper Length (ft)	75				75	
Lane Util. Factor	0.95	0.95	0.95	1.00	0.97	1.00
Frnt				0.850		0.850
Flt Protected		0.984			0.950	
Satd. Flow (prot)	0	3349	3194	1443	3268	1542
Flt Permitted		0.563			0.950	
Satd. Flow (perm)	0	1916	3194	1443	3268	1542
Right Turn on Red				Yes		Yes
Satd. Flow (RTOR)				359		49
Link Speed (mph)		45	45		35	
Link Distance (ft)		475	550		970	
Travel Time (s)		7.2	8.3		18.9	
Peak Hour Factor	0.94	0.94	0.94	0.94	0.94	0.94
Heavy Vehicles (%)	1%	1%	3%	2%	1%	2%
Adj. Flow (vph)	412	854	732	604	661	296
Shared Lane Traffic (%)						
Lane Group Flow (vph)	0	1266	732	604	661	296
Number of Detectors	1	1	1	1	1	1
Detector Template						
Leading Detector (ft)	50	5	5	5	35	35
Trailing Detector (ft)	0	0	0	0	-5	-5
Detector 1 Position (ft)	0	0	0	0	-5	-5
Detector 1 Size (ft)	50	5	5	5	40	40
Detector 1 Type	CI+Ex	CI+Ex	CI+Ex	CI+Ex	CI+Ex	CI+Ex
Detector 1 Channel						
Detector 1 Extend (s)	0.0	0.0	0.0	0.0	0.0	0.0
Detector 1 Queue (s)	0.0	0.0	0.0	0.0	0.0	0.0
Detector 1 Delay (s)	0.0	0.0	0.0	0.0	0.0	0.0
Turn Type	pm+pt	NA	NA	pm+ov	Prot	pm+ov
Protected Phases	5	2	6	4	4	5
Permitted Phases	2			6		4
Detector Phase	5	2	6	4	4	5
Switch Phase						
Minimum Initial (s)	3.0	20.0	20.0	7.0	7.0	3.0
Minimum Split (s)	9.0	26.0	26.0	14.0	14.0	9.0
Total Split (s)	38.0	81.0	43.0	39.0	39.0	38.0
Total Split (%)	31.7%	67.5%	35.8%	32.5%	32.5%	31.7%
Maximum Green (s)	32.0	75.0	37.0	32.0	32.0	32.0
Yellow Time (s)	4.0	4.0	4.0	4.0	4.0	4.0
All-Red Time (s)	2.0	2.0	2.0	3.0	3.0	2.0
Lost Time Adjust (s)		-1.0	-1.0	-1.0	-1.0	-1.0
Total Lost Time (s)		5.0	5.0	6.0	6.0	5.0



Lane Group	EBL	EBT	WBT	WBR	SBL	SBR
Lead/Lag	Lead		Lag		Lead	
Lead-Lag Optimize?						
Vehicle Extension (s)	3.0	3.0	3.0	3.0	3.0	3.0
Recall Mode	None	C-Max	C-Max	None	None	None
Act Effct Green (s)		78.1	65.5	101.4	30.9	44.5
Actuated g/C Ratio		0.65	0.55	0.84	0.26	0.37
v/c Ratio		0.99dl	0.42	0.47	0.79	0.49
Control Delay		23.2	18.7	4.5	48.7	26.6
Queue Delay		8.2	0.0	0.2	0.0	0.0
Total Delay		31.4	18.7	4.6	48.7	26.6
LOS		C	B	A	D	C
Approach Delay		31.4	12.3		41.9	
Approach LOS		C	B		D	
Queue Length 50th (ft)		205	212	125	241	142
Queue Length 95th (ft)		m#330	269	228	309	222
Internal Link Dist (ft)		395	470		890	
Turn Bay Length (ft)				210		415
Base Capacity (vph)		1337	1744	1294	898	918
Starvation Cap Reductn		0	0	154	0	0
Spillback Cap Reductn		72	0	0	0	0
Storage Cap Reductn		0	0	0	0	0
Reduced v/c Ratio		1.00	0.42	0.53	0.74	0.32

Intersection Summary

Area Type: Other
 Cycle Length: 120
 Actuated Cycle Length: 120
 Offset: 85 (71%), Referenced to phase 2:EBTL and 6:WBT, Start of 1st Green
 Natural Cycle: 75
 Control Type: Actuated-Coordinated
 Maximum v/c Ratio: 0.95
 Intersection Signal Delay: 27.1
 Intersection Capacity Utilization 87.4%
 Analysis Period (min) 15
 # 95th percentile volume exceeds capacity, queue may be longer.
 Queue shown is maximum after two cycles.
 m Volume for 95th percentile queue is metered by upstream signal.
 dl Defacto Left Lane. Recode with 1 though lane as a left lane.

Intersection LOS: C
 ICU Level of Service E

Splits and Phases: 2: Welsh Road & Dresher Road

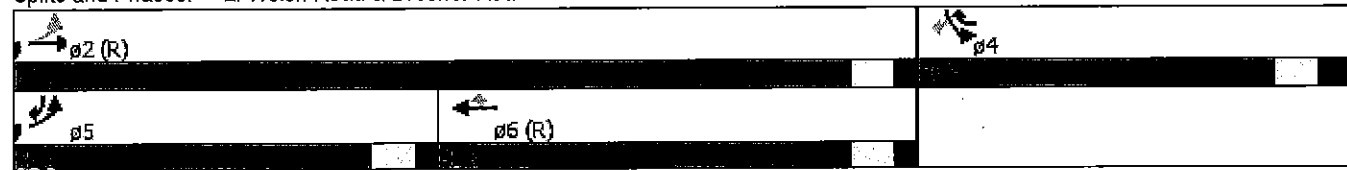

BT Dreshertown, LP
3: Dreshertown Road & Welsh Road

2015 Existing AM Peak



Lane Group	EFT	EBR	WBL	WBT	NBL	NBR
Lane Configurations	↑↑		↑	↑↑	↑↑	↑
Volume (vph)	899	525	404	981	275	373
Ideal Flow (vphpl)	1800	1800	1800	1800	1800	1800
Lane Width (ft)	12	12	10	12	12	15
Grade (%)	-2%			1%	1%	
Storage Length (ft)		0	175		0	350
Storage Lanes		0	1		2	2
Taper Length (ft)			75		75	
Lane Util. Factor	0.95	0.95	1.00	0.95	0.97	1.00
Friction	0.945					0.850
Flt Protected			0.950		0.950	
Satd. Flow (prot)	3208	0	1542	3304	3174	1626
Flt Permitted			0.064		0.950	
Satd. Flow (perm)	3208	0	104	3304	3174	1626
Right Turn on Red		Yes				Yes
Satd. Flow (RTOR)	112					41
Link Speed (mph)	45			45	40	
Link Distance (ft)	550			1040	778	
Travel Time (s)	8.3			15.8	13.3	
Peak Hour Factor	0.98	0.98	0.98	0.98	0.98	0.98
Heavy Vehicles (%)	1%	3%	3%	3%	4%	3%
Adj. Flow (vph)	917	536	412	1001	281	381
Shared Lane Traffic (%)						
Lane Group Flow (vph)	1453	0	412	1001	281	381
Number of Detectors	1		1	1	1	1
Detector Template						
Leading Detector (ft)	5		35	5	35	35
Trailing Detector (ft)	0		-5	0	-5	-5
Detector 1 Position(ft)	0		-5	0	-5	-5
Detector 1 Size(ft)	5		40	5	40	40
Detector 1 Type	CI+Ex		CI+Ex	CI+Ex	CI+Ex	CI+Ex
Detector 1 Channel						
Detector 1 Extend (s)	0.0		0.0	0.0	0.0	0.0
Detector 1 Queue (s)	0.0		0.0	0.0	0.0	0.0
Detector 1 Delay (s)	0.0		0.0	0.0	0.0	0.0
Turn Type	NA		pm+pt	NA	Prot	pm+ov
Protected Phases	2		1	6	8	1
Permitted Phases			6			8
Detector Phase	2		1	6	8	1
Switch Phase						
Minimum Initial (s)	20.0		3.0	20.0	7.0	3.0
Minimum Split (s)	27.0		10.0	27.0	14.0	10.0
Total Split (s)	51.0		35.0	86.0	34.0	35.0
Total Split (%)	42.5%		29.2%	71.7%	28.3%	29.2%
Maximum Green (s)	44.0		28.0	79.0	27.0	28.0
Yellow Time (s)	5.0		5.0	5.0	4.0	5.0
All-Red Time (s)	2.0		2.0	2.0	3.0	2.0
Lost Time Adjust (s)	-1.0		-1.0	-1.0	-1.0	-1.0
Total Lost Time (s)	6.0		6.0	6.0	6.0	6.0



Lane Group	EBT	EBR	WBL	WBT	NBL	NBR
Lead/Lag	Lag		Lead		Lead	
Lead-Lag Optimize?						
Vehicle Extension (s)	3.0		3.0	3.0	3.0	3.0
Recall Mode	C-Max		None	C-Max	None	None

Intersection Summary

Area Type: Other
 Cycle Length: 120
 Actuated Cycle Length: 120
 Offset: 85 (71%), Referenced to phase 2:EBT and 6:WBTL, Start of 1st Green
 Natural Cycle: 80
 Control Type: Actuated-Coordinated

Splits and Phases: 3: Dreshertown Road & Welsh Road

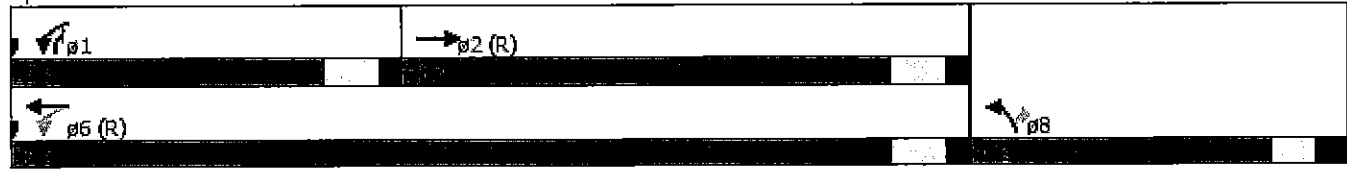



Movement	EBT	EBR	WBL	WBT	NBL	NBR
Lane Configurations	↑↑		↙	↑↑	↙↘	↗
Volume (veh/h)	899	525	404	981	275	373
Number	2	12	1	6	3	18
Initial Q (Qb), veh	0	0	0	0	0	0
Ped-Bike Adj(A_pbT)		1.00	1.00		1.00	1.00
Parking Bus, Adj	1.00	1.00	1.00	1.00	1.00	1.00
Adj Sat Flow, veh/h/ln	1787	1818	1739	1739	1722	1808
Adj Flow Rate, veh/h	917	492	412	1001	281	298
Adj No. of Lanes	2	0	1	2	2	1
Peak Hour Factor	0.98	0.98	0.98	0.98	0.98	0.98
Percent Heavy Veh, %	1	1	3	3	4	3
Cap, veh/h	1054	556	484	2333	617	553
Arrive On Green	0.98	0.96	0.33	1.00	0.19	0.19
Sat Flow, veh/h	2240	1134	1656	3391	3182	1537
Grp Volume(v), veh/h	720	689	412	1001	281	298
Grp Sat Flow(s),veh/h/ln	1698	1587	1656	1652	1591	1537
Q Serve(g_s), s	6.6	11.6	15.4	0.0	9.4	18.5
Cycle Q Clear(g_c), s	6.6	11.6	15.4	0.0	9.4	18.5
Prop In Lane		0.71	1.00		1.00	1.00
Lane Grp Cap(c), veh/h	832	778	484	2333	617	553
V/C Ratio(X)	0.87	0.89	0.85	0.43	0.46	0.54
Avail Cap(c_a), veh/h	832	778	609	2333	742	614
HCM Platoon Ratio	2.00	2.00	2.00	2.00	1.00	1.00
Upstream Filter(I)	0.33	0.33	0.88	0.88	1.00	1.00
Uniform Delay (d), s/veh	0.7	1.2	10.9	0.0	42.8	30.5
Incr Delay (d2), s/veh	4.3	5.4	8.2	0.5	0.5	0.8
Initial Q Delay(d3),s/veh	0.0	0.0	0.0	0.0	0.0	0.0
%ile BackOfQ(95%),veh/ln	3.1	5.5	12.1	0.3	7.5	12.6
LnGrp Delay(d),s/veh	5.0	6.5	19.1	0.5	43.3	31.3
LnGrp LOS	A	A	B	A	D	C
Approach Vol, veh/h	1409			1413	579	
Approach Delay, s/veh	5.7			5.9	37.1	
Approach LOS	A			A	D	

Timer	1	2	3	4	5	6	7	8
Assigned Phs	1	2				6		8
Phs Duration (G+Y+Rc), s	25.9	64.8				90.7		29.3
Change Period (Y+Rc), s	7.0	7.0				7.0		7.0
Max Green Setting (Gmax), s	28.0	44.0				79.0		27.0
Max Q Clear Time (g_c+I1), s	17.9	13.6				2.5		21.0
Green Ext Time (p_c), s	1.1	9.7				10.7		1.3

Intersection Summary	
HCM 2010 Ctrl Delay	11.2
HCM 2010 LOS	B

BT Dreshertown, LP
4: Dryden Road & Welsh Road

2015 Existing AM Peak



Lane Group	EBL	EBT	EBR	WBL	WBT	WER	NEL	NBT	NBR	SBL	SEBT	SBR
Lane Configurations	↖	↗	↗	↖	↗	↖	↖	↗		↖	↗	
Volume (vph)	1	1186	96	57	1445	1	2	0	0	2	0	0
Ideal Flow (vphpl)	1800	1800	1800	1800	1800	1800	1800	1800	1800	1800	1800	1800
Lane Width (ft)	10	12	14	10	12	12	11	15	15	12	14	14
Grade (%)		-1%			-1%			-1%			0%	
Storage Length (ft)	150		225	175		0	110		0	150		0
Storage Lanes	1		1	1		0	1		0	1		0
Taper Length (ft)	75			75			75			75		
Lane Util. Factor	1.00	0.95	1.00	1.00	0.95	0.95	1.00	1.00	1.00	1.00	1.00	1.00
Flt Protected	0.950			0.950			0.950			0.950		
Satd. Flow (prot)	1604	3403	1640	1573	3370	0	1661	1990	0	1710	1920	0
Flt Permitted	0.156			0.213								
Satd. Flow (perm)	263	3403	1640	353	3370	0	1749	1990	0	1800	1920	0
Right Turn on Red			Yes			Yes			Yes			Yes
Satd. Flow (RTOR)			103									
Link Speed (mph)		45			45			25			25	
Link Distance (ft)		1040			1416			754			960	
Travel Time (s)		15.8			21.5			20.6			26.2	
Peak Hour Factor	0.93	0.93	0.93	0.93	0.93	0.93	0.93	0.93	0.93	0.93	0.93	0.93
Heavy Vehicles (%)	0%	1%	0%	2%	2%	0%	0%	0%	0%	0%	0%	0%
Adj. Flow (vph)	1	1275	103	61	1554	1	2	0	0	2	0	0
Shared Lane Traffic (%)												
Lane Group Flow (vph)	1	1275	103	61	1555	0	2	0	0	2	0	0
Number of Detectors	1	1	1	1	1		1	1		1	1	
Detector Template												
Leading Detector (ft)	5	5	5	5	5		35	35		35	35	
Trailing Detector (ft)	0	0	0	0	0		-5	-5		-5	-5	
Detector 1 Position(ft)	0	0	0	0	0		-5	-5		-5	-5	
Detector 1 Size(ft)	5	5	5	5	5		40	40		40	40	
Detector 1 Type	Cl+Ex	Cl+Ex	Cl+Ex	Cl+Ex	Cl+Ex		Cl+Ex	Cl+Ex		Cl+Ex	Cl+Ex	
Detector 1 Channel												
Detector 1 Extend (s)	0.0	0.0	0.0	0.0	0.0		0.0	0.0		0.0	0.0	
Detector 1 Queue (s)	0.0	0.0	0.0	0.0	0.0		0.0	0.0		0.0	0.0	
Detector 1 Delay (s)	0.0	0.0	0.0	0.0	0.0		0.0	0.0		0.0	0.0	
Turn Type	Perm	NA	Perm	Perm	NA		Perm			Perm		
Protected Phases		2			6			8			4	
Permitted Phases	2		2	6			8			4		
Detector Phase	2	2	2	6	6		8	8		4	4	
Switch Phase												
Minimum Initial (s)	21.0	21.0	21.0	21.0	21.0		5.0	5.0		5.0	5.0	
Minimum Split (s)	27.0	27.0	27.0	27.0	27.0		11.0	11.0		11.0	11.0	
Total Split (s)	89.0	89.0	89.0	89.0	89.0		31.0	31.0		31.0	31.0	
Total Split (%)	74.2%	74.2%	74.2%	74.2%	74.2%		25.8%	25.8%		25.8%	25.8%	
Maximum Green (s)	83.0	83.0	83.0	83.0	83.0		25.0	25.0		25.0	25.0	
Yellow Time (s)	4.0	4.0	4.0	4.0	4.0		3.0	3.0		3.0	3.0	
All-Red Time (s)	2.0	2.0	2.0	2.0	2.0		3.0	3.0		3.0	3.0	
Lost Time Adjust (s)	-1.0	-1.0	-1.0	-1.0	-1.0		-1.0	-1.0		-1.0	-1.0	
Total Lost Time (s)	5.0	5.0	5.0	5.0	5.0		5.0	5.0		5.0	5.0	

BT Dreshertown, LP
 4: Dryden Road & Welsh Road

2015 Existing AM Peak



Lane Group	EBL	EBT	EBR	WEL	WBT	WER	NEL	NBT	NBR	SBL	SBT	SBR
Lead/Lag												
Lead-Lag Optimize?												
Vehicle Extension (s)	3.0	3.0	3.0	3.0	3.0		3.0	3.0		3.0	3.0	
Recall Mode	C-Max	C-Max	C-Max	C-Max	C-Max		None	None		None	None	

Intersection Summary

Area Type: Other
 Cycle Length: 120
 Actuated Cycle Length: 120
 Offset: 62 (52%), Referenced to phase 2:EBTL and 6:WBTL, Start of 1st Green
 Natural Cycle: 40
 Control Type: Actuated-Coordinated

Splits and Phases: 4: Dryden Road & Welsh Road

p2 (R)	p4
p6 (R)	p8

BT Dreshertown, LP
4: Dryden Road & Welsh Road

2015 Existing AM Peak



Movement	EBL	EBT	EBR	WBL	WBT	WBR	NEL	NBT	NBR	SBL	SBT	SBR
Lane Configurations	↖	↕	↗	↖	↕	↗	↖	↕	↗	↖	↕	↗
Volume (veh/h)	1	1186	96	57	1445	1	2	0	0	2	0	0
Number	5	2	12	1	6	16	3	8	18	7	4	14
Initial Q (Qb), veh	0	0	0	0	0	0	0	0	0	0	0	0
Ped-Bike Adj(A_pbT)	1.00		1.00	1.00		1.00	1.00		1.00	1.00		1.00
Parking Bus, Adj	1.00	1.00	1.00	1.00	1.00	1.00	1.00	1.00	1.00	1.00	1.00	1.00
Adj Sat Flow, veh/h/ln	1809	1791	1881	1774	1774	1809	1809	1881	1881	1800	1872	1872
Adj Flow Rate, veh/h	1	1275	101	61	1554	1	2	0	0	2	0	0
Adj No. of Lanes	1	2	1	1	2	0	1	1	0	1	1	0
Peak Hour Factor	0.93	0.93	0.93	0.93	0.93	0.93	0.93	0.93	0.93	0.93	0.93	0.93
Percent Heavy Veh, %	0	1	0	2	2	2	0	0	0	0	0	0
Cap, veh/h	339	3073	1444	416	3121	2	80	25	0	79	25	0
Arrive On Green	1.00	1.00	1.00	0.90	0.90	0.89	0.01	0.00	0.00	0.01	0.00	0.00
Sat Flow, veh/h	339	3403	1599	394	3456	2	1447	1881	0	1440	1872	0
Grp Volume(v), veh/h	1	1275	101	61	758	797	2	0	0	2	0	0
Grp Sat Flow(s),veh/h/ln	339	1702	1599	394	1685	1773	1447	1881	0	1440	1872	0
Q Serve(g_s), s	0.0	0.0	0.0	2.1	9.5	9.5	0.2	0.0	0.0	0.2	0.0	0.0
Cycle Q Clear(g_c), s	9.5	0.0	0.0	2.1	9.5	9.5	0.2	0.0	0.0	0.2	0.0	0.0
Prop In Lane	1.00		1.00	1.00		0.00	1.00		0.00	1.00		0.00
Lane Grp Cap(c), veh/h	339	3073	1444	416	1522	1601	80	25	0	79	25	0
V/C Ratio(X)	0.00	0.41	0.07	0.15	0.50	0.50	0.03	0.00	0.00	0.03	0.00	0.00
Avail Cap(c_a), veh/h	339	3073	1444	416	1522	1601	374	408	0	372	406	0
HCM Platoon Ratio	2.00	2.00	2.00	1.00	1.00	1.00	1.00	1.00	1.00	1.00	1.00	1.00
Upstream Filter(I)	0.42	0.42	0.42	1.00	1.00	1.00	1.00	0.00	0.00	1.00	0.00	0.00
Uniform Delay (d), s/veh	0.4	0.0	0.0	0.7	1.0	1.0	58.5	0.0	0.0	58.5	0.0	0.0
Incr Delay (d2), s/veh	0.0	0.2	0.0	0.7	1.2	1.1	0.1	0.0	0.0	0.1	0.0	0.0
Initial Q Delay(d3),s/veh	0.0	0.0	0.0	0.0	0.0	0.0	0.0	0.0	0.0	0.0	0.0	0.0
%ile BackOfQ(95%),veh/ln	0.0	0.1	0.0	0.6	8.3	8.6	0.1	0.0	0.0	0.1	0.0	0.0
LnGrp Delay(d),s/veh	0.4	0.2	0.0	1.4	2.2	2.1	58.6	0.0	0.0	58.6	0.0	0.0
LnGrp LOS	A	A	A	A	A	A	E			E		
Approach Vol, veh/h		1377			1616			2			2	
Approach Delay, s/veh		0.2			2.1			58.6			58.6	
Approach LOS		A			A			E			E	

Time	1	2	3	4	5	6	7	8
Assigned Phs		2		4		6		8
Phs Duration (G+Y+Rc), s		113.4		6.6		113.4		6.6
Change Period (Y+Rc), s		6.0		6.0		6.0		6.0
Max Green Setting (Gmax), s		83.0		25.0		83.0		25.0
Max Q Clear Time (g_c+I1), s		12.0		2.7		12.0		2.7
Green Ext Time (p_c), s		17.7		0.0		17.7		0.0

Intersection Summary	
HCM 2010 Ctrl Delay	1.3
HCM 2010 LOS	A

BT Dreshertown, LP
 1: Jarrettown Road/Village Road & Welsh Road

2015 Existing PM Peak



Lane Group	EBL	EBT	EBR	WBL	WBT	WBR	NBL	NBT	NBR	SDL	SBT	SBR
Lane Configurations	↖	↗		↖	↗			↕			↕	
Volume (vph)	21	758	22	242	946	14	16	20	239	40	89	103
Ideal Flow (vphpl)	1800	1800	1800	1800	1800	1800	1800	1800	1800	1800	1800	1800
Lane Width (ft)	12	12	12	11	14	14	12	12	12	15	15	15
Grade (%)		-6%			1%			-1%			1%	
Storage Length (ft)	150		0	100		0	0		0	0		0
Storage Lanes	1		0	1		0	0		0	0		0
Taper Length (ft)	75			75			75			75		
Lane Util. Factor	1.00	1.00	1.00	1.00	1.00	1.00	1.00	1.00	1.00	1.00	1.00	1.00
Frnt		0.996			0.998			0.883			0.940	
Flt Protected	0.950			0.950				0.997			0.991	
Satd. Flow (prot)	1761	1829	0	1645	1907	0	0	1593	0	0	1826	0
Flt Permitted	0.238			0.104				0.953			0.682	
Satd. Flow (perm)	441	1829	0	180	1907	0	0	1522	0	0	1256	0
Right Turn on Red			Yes			Yes			Yes			Yes
Satd. Flow (RTOR)		2			1			249			30	
Link Speed (mph)		45			45			35			35	
Link Distance (ft)		1263			605			421			431	
Travel Time (s)		19.1			9.2			8.2			8.4	
Peak Hour Factor	0.96	0.96	0.96	0.96	0.96	0.96	0.96	0.96	0.96	0.96	0.96	0.96
Heavy Vehicles (%)	0%	1%	0%	0%	0%	0%	0%	0%	0%	3%	0%	0%
Adj. Flow (vph)	22	790	23	252	985	15	17	21	249	42	93	107
Shared Lane Traffic (%)												
Lane Group Flow (vph)	22	813	0	252	1000	0	0	287	0	0	242	0
Number of Detectors	1	2		1	2		1	1		1	1	
Detector Template	Left			Left			Left	Thru		Left	Thru	
Leading Detector (ft)	5	330		35	330		20	35		20	35	
Trailing Detector (ft)	0	0		-5	0		0	-5		0	-5	
Detector 1 Position(ft)	0	0		-5	0		0	-5		0	-5	
Detector 1 Size(ft)	5	6		40	6		20	40		20	40	
Detector 1 Type	Cl+Ex	Cl+Ex		Cl+Ex	Cl+Ex		Cl+Ex	Cl+Ex		Cl+Ex	Cl+Ex	
Detector 1 Channel												
Detector 1 Extend (s)	0.0	0.0		0.0	0.0		0.0	0.0		0.0	0.0	
Detector 1 Queue (s)	0.0	0.0		0.0	0.0		0.0	0.0		0.0	0.0	
Detector 1 Delay (s)	0.0	0.0		0.0	0.0		0.0	0.0		0.0	0.0	
Detector 2 Position(ft)		324			324							
Detector 2 Size(ft)		6			6							
Detector 2 Type		Cl+Ex			Cl+Ex							
Detector 2 Channel												
Detector 2 Extend (s)		0.0			0.0							
Turn Type	Perm	NA		pm+pt	NA		Perm	NA		Perm	NA	
Protected Phases		2		1	6			8			4	
Permitted Phases	2			6			8			4		
Detector Phase	2	2		1	6		8	8		4	4	
Switch Phase												
Minimum Initial (s)	15.0	15.0		3.0	15.0		7.0	7.0		7.0	7.0	
Minimum Split (s)	22.0	22.0		10.0	22.0		13.0	13.0		13.0	13.0	
Total Split (s)	62.0	62.0		27.0	89.0		31.0	31.0		31.0	31.0	
Total Split (%)	51.7%	51.7%		22.5%	74.2%		25.8%	25.8%		25.8%	25.8%	

BT Dreshertown, LP
 1: Jarrettown Road/Village Road & Welsh Road

2015 Existing PM Peak



Lane Group	EBL	EBT	EBR	WBL	WBT	WBR	NBL	NBT	NBR	SBL	SBT	SBR
Maximum Green (s)	55.0	55.0		20.0	82.0		25.0	25.0		25.0	25.0	
Yellow Time (s)	5.0	5.0		5.0	5.0		4.0	4.0		4.0	4.0	
All-Red Time (s)	2.0	2.0		2.0	2.0		2.0	2.0		2.0	2.0	
Lost Time Adjust (s)	-1.0	-1.0		-1.0	-1.0			-1.0			-1.0	
Total Lost Time (s)	6.0	6.0		6.0	6.0			5.0			5.0	
Lead/Lag	Lag	Lag		Lead								
Lead-Lag Optimize?												
Vehicle Extension (s)	3.0	3.0		3.0	3.0		3.0	3.0		3.0	3.0	
Recall Mode	C-Max	C-Max		None	C-Max		None	None		None	None	

Intersection Summary

Area Type: Other
 Cycle Length: 120
 Actuated Cycle Length: 120
 Offset: 5 (4%), Referenced to phase 2:EBTL and 6:WBTL, Start of 1st Green
 Natural Cycle: 80
 Control Type: Actuated-Coordinated

Splits and Phases: 1: Jarrettown Road/Village Road & Welsh Road



BT Dreshertown, LP
 1: Jarrettown Road/Village Road & Welsh Road

2015 Existing PM Peak



Movement	EBL	EBT	EBR	WBL	WBT	WBR	NEL	NBT	NBR	SBL	SBH	SBR
Lane Configurations	↖	↗		↖	↗			↕			↕	
Volume (veh/h)	21	758	22	242	946	14	16	20	239	40	89	103
Number	5	2	12	1	6	16	3	8	18	7	4	14
Initial Q (Qb), veh	0	0	0	0	0	0	0	0	0	0	0	0
Ped-Bike Adj(A_pbT)	1.00		1.00	1.00		1.00	1.00		1.00	1.00		1.00
Parking Bus, Adj	1.00	1.00	1.00	1.00	1.00	1.00	1.00	1.00	1.00	1.00	1.00	1.00
Adj Sat Flow, veh/h/ln	1854	1836	1854	1791	1863	1863	1809	1809	1809	1863	1853	1863
Adj Flow Rate, veh/h	22	790	22	252	985	14	17	21	228	42	93	93
Adj No. of Lanes	1	1	0	1	1	0	0	1	0	0	1	0
Peak Hour Factor	0.96	0.96	0.96	0.96	0.96	0.96	0.96	0.96	0.96	0.96	0.96	0.96
Percent Heavy Veh, %	0	1	1	0	0	0	0	0	0	0	0	0
Cap, veh/h	291	1029	29	378	1314	19	43	33	264	70	127	111
Arrive On Green	0.58	0.58	0.57	0.09	0.72	0.71	0.18	0.19	0.19	0.18	0.19	0.18
Sat Flow, veh/h	590	1778	50	1706	1832	26	57	173	1382	182	664	583
Grp Volume(v), veh/h	22	0	812	252	0	999	266	0	0	228	0	0
Grp Sat Flow(s),veh/h/ln	590	0	1827	1706	0	1858	1612	0	0	1428	0	0
Q Serve(g_s), s	2.8	0.0	40.4	6.5	0.0	39.5	0.3	0.0	0.0	0.0	0.0	0.0
Cycle Q Clear(g_c), s	25.2	0.0	40.4	6.5	0.0	39.5	19.2	0.0	0.0	18.9	0.0	0.0
Prop In Lane	1.00		0.03	1.00		0.01	0.06		0.86	0.18		0.41
Lane Grp Cap(c), veh/h	291	0	1058	378	0	1333	327	0	0	297	0	0
V/C Ratio(X)	0.08	0.00	0.77	0.67	0.00	0.75	0.81	0.00	0.00	0.77	0.00	0.00
Avail Cap(c_a), veh/h	291	0	1058	526	0	1333	366	0	0	337	0	0
HCM Platoon Ratio	1.00	1.00	1.00	1.00	1.00	1.00	1.00	1.00	1.00	1.00	1.00	1.00
Upstream Filter(I)	1.00	0.00	1.00	1.00	0.00	1.00	1.00	0.00	0.00	1.00	0.00	0.00
Uniform Delay (d), s/veh	23.0	0.0	19.1	18.8	0.0	10.4	47.2	0.0	0.0	46.6	0.0	0.0
Incr Delay (d2), s/veh	0.5	0.0	5.3	2.0	0.0	3.9	12.1	0.0	0.0	9.1	0.0	0.0
Initial Q Delay(d3),s/veh	0.0	0.0	0.0	0.0	0.0	0.0	0.0	0.0	0.0	0.0	0.0	0.0
%ile BackOfQ(95%),veh/ln	0.9	0.0	29.5	8.4	0.0	29.0	14.9	0.0	0.0	12.9	0.0	0.0
LnGrp Delay(d),s/veh	23.5	0.0	24.5	20.8	0.0	14.3	59.3	0.0	0.0	55.7	0.0	0.0
LnGrp LOS	C		C	C		B	E			E		
Approach Vol, veh/h		834			1251			266			228	
Approach Delay, s/veh		24.5			15.6			59.3			55.7	
Approach LOS		C			B			E			E	

Filter	1	2	3	4	5	6	7	8
Assigned Phs	1	2		4		6		8
Phs Duration (G+Y+Rc), s	16.6	75.5		27.9		92.1		27.9
Change Period (Y+Rc), s	7.0	7.0		6.0		7.0		6.0
Max Green Setting (Gmax), s	20.0	55.0		25.0		82.0		25.0
Max Q Clear Time (g_c+I1), s	9.0	42.4		20.9		41.5		21.2
Green Ext Time (p_c), s	0.6	12.2		0.8		37.8		0.8

Intersection Summary	
HCM 2010 Ctrl Delay	26.5
HCM 2010 LOS	C

BT Dreshertown, LP
2: Welsh Road & Dresher Road

2015 Existing PM Peak

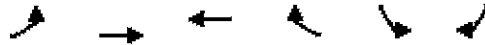

Lane Group	EBL	EBT	WBT	WBR	SBL	SBR
Lane Configurations		↔↕	↕↔	↕	↕↕	↕
Volume (vph)	272	820	881	527	819	384
Ideal Flow (vphpl)	1800	1800	1800	1800	1800	1800
Lane Width (ft)	12	12	11	11	12	13
Grade (%)		-1%	1%		1%	
Storage Length (ft)	0			210	0	415
Storage Lanes	0			1	2	1
Taper Length (ft)	75				75	
Lane Util. Factor	0.95	0.95	0.95	1.00	0.97	1.00
Frnt				0.850		0.850
Flt Protected		0.988			0.950	
Satd. Flow (prot)	0	3337	3257	1457	3268	1558
Flt Permitted		0.534			0.950	
Satd. Flow (perm)	0	1804	3257	1457	3268	1558
Right Turn on Red				Yes		Yes
Satd. Flow (RTOR)				449		55
Link Speed (mph)		45	45		35	
Link Distance (ft)		475	550		970	
Travel Time (s)		7.2	8.3		18.9	
Peak Hour Factor	0.95	0.95	0.95	0.95	0.95	0.95
Heavy Vehicles (%)	1%	2%	1%	1%	1%	1%
Adj. Flow (vph)	286	863	927	555	862	404
Shared Lane Traffic (%)						
Lane Group Flow (vph)	0	1149	927	555	862	404
Number of Detectors	1	1	1	1	1	1
Detector Template						
Leading Detector (ft)	50	5	5	5	35	35
Trailing Detector (ft)	0	0	0	0	-5	-5
Detector 1 Position(ft)	0	0	0	0	-5	-5
Detector 1 Size(ft)	50	5	5	5	40	40
Detector 1 Type	Cl+Ex	Cl+Ex	Cl+Ex	Cl+Ex	Cl+Ex	Cl+Ex
Detector 1 Channel						
Detector 1 Extend (s)	0.0	0.0	0.0	0.0	0.0	0.0
Detector 1 Queue (s)	0.0	0.0	0.0	0.0	0.0	0.0
Detector 1 Delay (s)	0.0	0.0	0.0	0.0	0.0	0.0
Turn Type	pm+pt	NA	NA	pm+ov	Prot	pm+ov
Protected Phases	5	2	6	4	4	5
Permitted Phases	2			6		4
Detector Phase	5	2	6	4	4	5
Switch Phase						
Minimum Initial (s)	3.0	20.0	20.0	7.0	7.0	3.0
Minimum Split (s)	9.0	26.0	26.0	14.0	14.0	9.0
Total Split (s)	25.0	80.0	55.0	40.0	40.0	25.0
Total Split (%)	20.8%	66.7%	45.8%	33.3%	33.3%	20.8%
Maximum Green (s)	19.0	74.0	49.0	33.0	33.0	19.0
Yellow Time (s)	4.0	4.0	4.0	4.0	4.0	4.0
All-Red Time (s)	2.0	2.0	2.0	3.0	3.0	2.0
Lost Time Adjust (s)		-1.0	-1.0	-1.0	-1.0	-1.0
Total Lost Time (s)		5.0	5.0	6.0	6.0	5.0

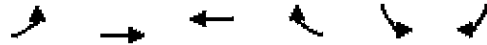

Lane Group	EBL	EBT	WBT	WBR	SEB	SEB
Lead/Lag	Lead		Lag		Lead	
Lead-Lag Optimize?						
Vehicle Extension (s)	3.0	3.0	3.0	3.0	3.0	3.0
Recall Mode	None	C-Max	C-Max	None	None	None
Act Effct Green (s)		75.1	61.7	100.7	33.9	48.3
Actuated g/C Ratio		0.63	0.51	0.84	0.28	0.40
v/c Ratio		0.93	0.55	0.43	0.93	0.61
Control Delay		39.1	23.6	1.7	59.6	28.8
Queue Delay		0.0	0.3	0.2	46.4	0.0
Total Delay		39.1	23.9	1.9	106.0	28.8
LOS		D	C	A	F	C
Approach Delay		39.1	15.6		81.4	
Approach LOS		D	B		F	
Queue Length 50th (ft)		424	251	0	335	213
Queue Length 95th (ft)		#499	311	82	#457	314
Internal Link Dist (ft)		395	470		890	
Turn Bay Length (ft)				210		415
Base Capacity (vph)		1234	1675	1295	925	805
Starvation Cap Reductn		0	241	197	0	0
Spillback Cap Reductn		0	0	0	290	0
Storage Cap Reductn		0	0	0	0	0
Reduced v/c Ratio		0.93	0.65	0.51	1.36	0.50

Intersection Summary

Area Type: Other
 Cycle Length: 120
 Actuated Cycle Length: 120
 Offset: 77 (64%), Referenced to phase 2:EBTL and 6:WBT, Start of 1st Green
 Natural Cycle: 90
 Control Type: Actuated-Coordinated
 Maximum v/c Ratio: 0.93
 Intersection Signal Delay: 43.9
 Intersection Capacity Utilization 96.0%
 Analysis Period (min) 15
 # 95th percentile volume exceeds capacity, queue may be longer.
 Queue shown is maximum after two cycles.

Splits and Phases: 2: Welsh Road & Dresher Road

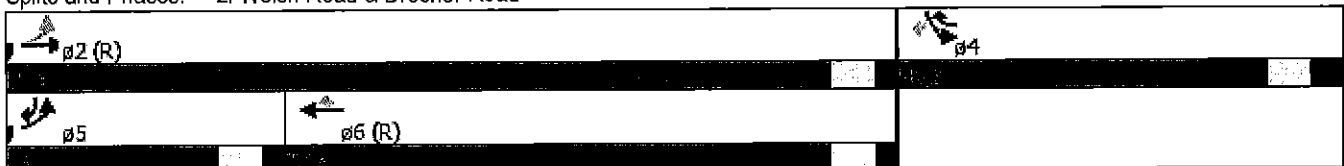

BT Dreshertown, LP
 3: Dreshertown Road & Welsh Road

2015 Existing PM Peak



Lane Group	EBT	EBR	WBL	WBT	NBL	NBR
Lane Configurations	↑↑		↙	↑↑	↘	↗
Volume (vph)	1083	556	447	1020	388	443
Ideal Flow (vphpl)	1800	1800	1800	1800	1800	1800
Lane Width (ft)	12	12	10	12	12	15
Grade (%)	-2%			1%	1%	
Storage Length (ft)		0	175		0	350
Storage Lanes		0	1		2	2
Taper Length (ft)			75		75	
Lane Util. Factor	0.95	0.95	1.00	0.95	0.97	1.00
Frnt	0.949					0.850
Flt Protected			0.950		0.950	
Satd. Flow (prot)	3224	0	1557	3369	3268	1626
Flt Permitted			0.075		0.950	
Satd. Flow (perm)	3224	0	123	3369	3268	1626
Right Turn on Red		Yes				Yes
Satd. Flow (RTOR)	85					15
Link Speed (mph)	45			45	40	
Link Distance (ft)	550			1040	778	
Travel Time (s)	8.3			15.8	13.3	
Peak Hour Factor	0.96	0.96	0.96	0.96	0.96	0.96
Heavy Vehicles (%)	2%	1%	2%	1%	1%	3%
Adj. Flow (vph)	1128	579	466	1062	404	461
Shared Lane Traffic (%)						
Lane Group Flow (vph)	1707	0	466	1062	404	461
Number of Detectors	1		1	1	1	1
Detector Template						
Leading Detector (ft)	5		35	5	35	35
Trailing Detector (ft)	0		-5	0	-5	-5
Detector 1 Position(ft)	0		-5	0	-5	-5
Detector 1 Size(ft)	5		40	5	40	40
Detector 1 Type	CI+Ex		CI+Ex	CI+Ex	CI+Ex	CI+Ex
Detector 1 Channel						
Detector 1 Extend (s)	0.0		0.0	0.0	0.0	0.0
Detector 1 Queue (s)	0.0		0.0	0.0	0.0	0.0
Detector 1 Delay (s)	0.0		0.0	0.0	0.0	0.0
Turn Type	NA		pm+pt	NA	Prot	pm+ov
Protected Phases	2		1	6	8	1
Permitted Phases			6			8
Detector Phase	2		1	6	8	1
Switch Phase						
Minimum Initial (s)	20.0		3.0	20.0	7.0	3.0
Minimum Split (s)	27.0		10.0	27.0	14.0	10.0
Total Split (s)	49.0		44.0	93.0	27.0	44.0
Total Split (%)	40.8%		36.7%	77.5%	22.5%	36.7%
Maximum Green (s)	42.0		37.0	86.0	20.0	37.0
Yellow Time (s)	5.0		5.0	5.0	4.0	5.0
All-Red Time (s)	2.0		2.0	2.0	3.0	2.0
Lost Time Adjust (s)	-1.0		-1.0	-1.0	-1.0	-1.0
Total Lost Time (s)	6.0		6.0	6.0	6.0	6.0

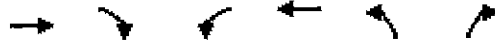

Lane Group	EBT	EBR	WBL	WBT	NBL	NBR
Lead/Lag	Lag		Lead		Lead	
Lead-Lag Optimize?						
Vehicle Extension (s)	3.0		3.0	3.0	3.0	3.0
Recall Mode	C-Max		None	C-Max	None	None

Intersection Summary

Area Type: Other
 Cycle Length: 120
 Actuated Cycle Length: 120
 Offset: 29 (24%), Referenced to phase 2:EBT and 6:WBTL, Start of 1st Green
 Natural Cycle: 120
 Control Type: Actuated-Coordinated

Splits and Phases: 3: Dreshertown Road & Welsh Road

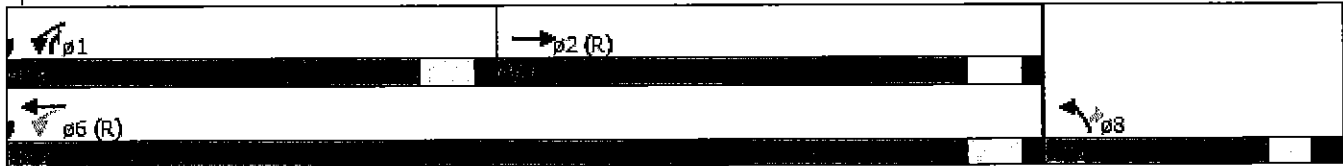



Movement	EBT	EBR	WBL	WBT	NBL	NBR
Lane Configurations	↑↑		↑	↑↑	↑↑	↑
Volume (veh/h)	1083	556	447	1020	388	443
Number	2	12	1	6	3	18
Initial Q (Qb), veh	0	0	0	0	0	0
Ped-Bike Adj(A_pbT)		1.00	1.00		1.00	1.00
Parking Bus, Adj	1.00	1.00	1.00	1.00	1.00	1.00
Adj Sat Flow, veh/h/ln	1788	1818	1756	1773	1773	1808
Adj Flow Rate, veh/h	1128	553	466	1062	404	415
Adj No. of Lanes	2	0	1	2	2	1
Peak Hour Factor	0.96	0.96	0.96	0.96	0.96	0.96
Percent Heavy Veh, %	2	2	2	1	1	3
Cap, veh/h	933	438	494	2443	573	668
Arrive On Green	0.42	0.41	0.52	1.00	0.17	0.17
Sat Flow, veh/h	2335	1055	1672	3458	3276	1537
Grp Volume(v), veh/h	841	840	466	1062	404	415
Grp Sat Flow(s),veh/h/ln	1699	1602	1672	1685	1638	1537
Q Serve(g_s), s	49.8	49.8	26.6	0.0	13.9	21.0
Cycle Q Clear(g_c), s	49.8	49.8	26.6	0.0	13.9	21.0
Prop In Lane		0.66	1.00		1.00	1.00
Lane Grp Cap(c), veh/h	706	665	494	2443	573	668
V/C Ratio(X)	1.19	1.26	0.94	0.43	0.70	0.62
Avail Cap(c_a), veh/h	706	665	590	2443	573	668
HCM Platoon Ratio	1.00	1.00	2.00	2.00	1.00	1.00
Upstream Filter(I)	0.25	0.25	0.83	0.83	1.00	1.00
Uniform Delay (d), s/veh	35.1	35.4	21.3	0.0	46.6	26.3
Incr Delay (d2), s/veh	90.3	121.0	19.2	0.5	3.9	1.8
Initial Q Delay(d3),s/veh	0.0	0.0	0.0	0.0	0.0	0.0
%ile BackOfQ(95%),veh/ln	73.7	79.4	22.7	0.3	10.8	16.3
LnGrp Delay(d),s/veh	125.4	156.5	40.5	0.5	50.5	28.0
LnGrp LOS	F	F	D	A	D	C
Approach Vol, veh/h	1681			1528	819	
Approach Delay, s/veh	140.9			12.7	39.1	
Approach LOS	F			B	D	

Phase	1	2	3	4	5	6	7	8
Assigned Phs	1	2				6		8
Phs Duration (G+Y+Rc), s	37.2	55.8				93.0		27.0
Change Period (Y+Rc), s	7.0	7.0				7.0		7.0
Max Green Setting (Gmax), s	37.0	42.0				86.0		20.0
Max Q Clear Time (g_c+I1), s	29.1	52.3				2.5		23.5
Green Ext Time (p_c), s	1.1	0.0				14.5		0.0

Intersection Summary	
HCM 2010 Ctrl Delay	71.6
HCM 2010 LOS	E

BT Dreshertown, LP
4: Dryden Road & Welsh Road

2015 Existing PM Peak



Lane Group	EBL	EBT	EBR	WBL	WBT	WBR	NBL	NBT	NBR	SBL	SBT	SBR
Lane Configurations	↖	↗	↗	↖	↔		↖	↗		↖	↗	
Volume (vph)	0	1557	5	0	1369	0	95	8	9	3	0	1
Ideal Flow (vphpl)	1800	1800	1800	1800	1800	1800	1800	1800	1800	1800	1800	1800
Lane Width (ft)	10	12	14	10	12	12	11	15	15	12	14	14
Grade (%)		-1%			-1%			-1%			0%	
Storage Length (ft)	150		225	175		0	110		0	150		0
Storage Lanes	1		1	1		0	1		0	1		0
Taper Length (ft)	75			75			75			75		
Lane Util. Factor	1.00	0.95	1.00	1.00	0.95	0.95	1.00	1.00	1.00	1.00	1.00	1.00
Flt Protected			0.850				0.950			0.950		
Satd. Flow (prot)	1688	3403	1640	1688	3370	0	1661	1833	0	1710	1632	0
Flt Permitted							0.757			0.746		
Satd. Flow (perm)	1688	3403	1640	1688	3370	0	1324	1833	0	1343	1632	0
Right Turn on Red			Yes			Yes			Yes			Yes
Satd. Flow (RTOR)			27					9			36	
Link Speed (mph)		45			45			25			25	
Link Distance (ft)		1040			1416			754			960	
Travel Time (s)		15.8			21.5			20.6			26.2	
Peak Hour Factor	0.97	0.97	0.97	0.97	0.97	0.97	0.97	0.97	0.97	0.97	0.97	0.97
Heavy Vehicles (%)	0%	1%	0%	0%	2%	0%	0%	0%	0%	0%	0%	0%
Adj. Flow (vph)	0	1605	5	0	1411	0	98	8	9	3	0	1
Shared Lane Traffic (%)												
Lane Group Flow (vph)	0	1605	5	0	1411	0	98	17	0	3	1	0
Number of Detectors	1	1	1	1	1		1	1		1	1	
Detector Template												
Leading Detector (ft)	5	5	5	5	5		35	35		35	35	
Trailing Detector (ft)	0	0	0	0	0		-5	-5		-5	-5	
Detector 1 Position(ft)	0	0	0	0	0		-5	-5		-5	-5	
Detector 1 Size(ft)	5	5	5	5	5		40	40		40	40	
Detector 1 Type	Cl+Ex	Cl+Ex	Cl+Ex	Cl+Ex	Cl+Ex		Cl+Ex	Cl+Ex		Cl+Ex	Cl+Ex	
Detector 1 Channel												
Detector 1 Extend (s)	0.0	0.0	0.0	0.0	0.0		0.0	0.0		0.0	0.0	
Detector 1 Queue (s)	0.0	0.0	0.0	0.0	0.0		0.0	0.0		0.0	0.0	
Detector 1 Delay (s)	0.0	0.0	0.0	0.0	0.0		0.0	0.0		0.0	0.0	
Turn Type	Perm	NA	Perm	Perm	NA		Perm	NA		Perm	NA	
Protected Phases		2			6			8			4	
Permitted Phases	2		2	6			8			4		4
Detector Phase	2	2	2	6	6		8	8		4	4	
Switch Phase												
Minimum Initial (s)	21.0	21.0	21.0	21.0	21.0		5.0	5.0		5.0	5.0	
Minimum Split (s)	27.0	27.0	27.0	27.0	27.0		11.0	11.0		11.0	11.0	
Total Split (s)	72.0	72.0	72.0	72.0	72.0		48.0	48.0		48.0	48.0	
Total Split (%)	60.0%	60.0%	60.0%	60.0%	60.0%		40.0%	40.0%		40.0%	40.0%	
Maximum Green (s)	66.0	66.0	66.0	66.0	66.0		42.0	42.0		42.0	42.0	
Yellow Time (s)	4.0	4.0	4.0	4.0	4.0		3.0	3.0		3.0	3.0	
All-Red Time (s)	2.0	2.0	2.0	2.0	2.0		3.0	3.0		3.0	3.0	
Lost Time Adjust (s)	-1.0	-1.0	-1.0	-1.0	-1.0		-1.0	-1.0		-1.0	-1.0	
Total Lost Time (s)	5.0	5.0	5.0	5.0	5.0		5.0	5.0		5.0	5.0	

BT Dreshertown, LP
 4: Dryden Road & Welsh Road

2015 Existing PM Peak



Lane Group	EBL	EBT	EBR	WBL	WBT	WBR	NBL	NBT	NBR	SBL	SBT	SBR
Lead/Lag												
Lead-Lag Optimize?												
Vehicle Extension (s)	3.0	3.0	3.0	3.0	3.0		3.0	3.0		3.0	3.0	
Recall Mode	C-Max	C-Max	C-Max	C-Max	C-Max		None	None		None	None	

Intersection Summary

Area Type: Other

Cycle Length: 120

Actuated Cycle Length: 120

Offset: 59 (49%), Referenced to phase 2:EBTL and 6:WBTL, Start of 1st Green

Natural Cycle: 45

Control Type: Actuated-Coordinated

Splits and Phases: 4: Dryden Road & Welsh Road

p2 (R)	p4
p6 (R)	p8

BT Dreshertown, LP
4: Dryden Road & Welsh Road

2015 Existing PM Peak



Movement	EBL	EBT	EBR	WBL	WBT	WBR	NBL	NBT	NBR	SBL	SBT	SBR
Lane Configurations	↖	↕	↗	↖	↕	↗	↖	↕	↗	↖	↕	↗
Volume (veh/h)	0	1557	5	0	1369	0	95	8	9	3	0	1
Number	5	2	12	1	6	16	3	8	18	7	4	14
Initial Q (Qb), veh	0	0	0	0	0	0	0	0	0	0	0	0
Ped-Bike Adj(A_pbT)	1.00		1.00	1.00		1.00	1.00		1.00	1.00		1.00
Parking Bus, Adj	1.00	1.00	1.00	1.00	1.00	1.00	1.00	1.00	1.00	1.00	1.00	1.00
Adj Sat Flow, veh/h/ln	1809	1791	1881	1809	1774	1809	1809	1881	1881	1800	1872	1872
Adj Flow Rate, veh/h	0	1605	3	0	1411	0	98	8	9	3	0	1
Adj No. of Lanes	1	2	1	1	2	0	1	1	0	1	1	0
Peak Hour Factor	0.97	0.97	0.97	0.97	0.97	0.97	0.97	0.97	0.97	0.97	0.97	0.97
Percent Heavy Veh, %	0	1	0	0	2	2	0	0	0	0	0	0
Cap, veh/h	60	2792	1312	60	2765	0	199	78	88	190	0	153
Arrive On Green	0.00	1.00	1.00	0.00	0.82	0.00	0.10	0.10	0.09	0.10	0.00	0.09
Sat Flow, veh/h	389	3403	1599	322	3458	0	1446	810	911	1418	0	1591
Grp Volume(v), veh/h	0	1605	3	0	1411	0	98	0	17	3	0	1
Grp Sat Flow(s),veh/h/ln	389	1702	1599	322	1685	0	1446	0	1721	1418	0	1591
Q Serve(g_s), s	0.0	0.0	0.0	0.0	15.5	0.0	7.9	0.0	1.1	0.2	0.0	0.1
Cycle Q Clear(g_c), s	0.0	0.0	0.0	0.0	15.5	0.0	7.9	0.0	1.1	0.8	0.0	0.1
Prop In Lane	1.00		1.00	1.00		0.00	1.00		0.53	1.00		1.00
Lane Grp Cap(c), veh/h	60	2792	1312	60	2765	0	199	0	166	190	0	153
V/C Ratio(X)	0.00	0.57	0.00	0.00	0.51	0.00	0.49	0.00	0.10	0.02	0.00	0.01
Avail Cap(c_a), veh/h	60	2792	1312	60	2765	0	578	0	617	561	0	570
HCM Platoon Ratio	2.00	2.00	2.00	1.00	1.00	1.00	1.00	1.00	1.00	1.00	1.00	1.00
Upstream Filter(I)	0.00	0.09	0.09	0.00	1.00	0.00	1.00	0.00	1.00	1.00	0.00	1.00
Uniform Delay (d), s/veh	0.0	0.0	0.0	0.0	3.3	0.0	52.6	0.0	49.7	49.6	0.0	49.5
Incr Delay (d2), s/veh	0.0	0.1	0.0	0.0	0.7	0.0	1.9	0.0	0.3	0.0	0.0	0.0
Initial Q Delay(d3),s/veh	0.0	0.0	0.0	0.0	0.0	0.0	0.0	0.0	0.0	0.0	0.0	0.0
%ile BackOfQ(95%),veh/ln	0.0	0.1	0.0	0.0	11.8	0.0	5.9	0.0	1.0	0.2	0.0	0.1
LnGrp Delay(d),s/veh	0.0	0.1	0.0	0.0	4.0	0.0	54.4	0.0	50.0	49.7	0.0	49.5
LnGrp LOS		A	A		A		D		D	D		D
Approach Vol, veh/h		1608			1411			115				4
Approach Delay, s/veh		0.1			4.0			53.8				49.6
Approach LOS		A			A			D				D

Time	1	2	3	4	5	6	7	8
Assigned Phs		2		4		6		8
Phs Duration (G+Y+Rc), s		103.4		16.6		103.4		16.6
Change Period (Y+Rc), s		6.0		6.0		6.0		6.0
Max Green Setting (Gmax), s		66.0		42.0		66.0		42.0
Max Q Clear Time (g_c+I1), s		2.5		3.3		18.0		10.4
Green Ext Time (p_c), s		19.2		0.4		18.0		0.4

Intersection Summary	
HCM 2010 Ctrl Delay	3.9
HCM 2010 LOS	A

1: Jarrettown Road/Village Road & Welsh Road



Lane Group	EBL	EBT	EBR	WBL	WBT	WBR	NBL	NBT	NBR	SBL	SBT	SBR
Lane Configurations												
Volume (vph)	10	574	16	123	537	8	4	2	169	12	2	7
Ideal Flow (vphpl)	1800	1800	1800	1800	1800	1800	1800	1800	1800	1800	1800	1800
Lane Width (ft)	12	12	12	11	14	14	12	12	12	15	15	15
Grade (%)		-6%			1%			-1%			1%	
Storage Length (ft)	150		0	100		0	0		0	0		0
Storage Lanes	1		0	1		0	0		0	0		0
Taper Length (ft)	75			75			75			75		
Lane Util. Factor	1.00	1.00	1.00	1.00	1.00	1.00	1.00	1.00	1.00	1.00	1.00	1.00
Fr't		0.996			0.998			0.869			0.953	
Flt Protected	0.950			0.950				0.999			0.973	
Satd. Flow (prot)	1761	1816	0	1612	1907	0	0	1570	0	0	1827	0
Flt Permitted	0.438			0.304				0.993			0.377	
Satd. Flow (perm)	812	1816	0	516	1907	0	0	1561	0	0	708	0
Right Turn on Red			Yes			Yes			Yes			Yes
Satd. Flow (RTOR)		2			2			186			8	
Link Speed (mph)		45			45			35			35	
Link Distance (ft)		1263			605			421			431	
Travel Time (s)		19.1			9.2			8.2			8.4	
Peak Hour Factor	0.91	0.91	0.91	0.91	0.91	0.91	0.91	0.91	0.91	0.91	0.91	0.91
Heavy Vehicles (%)	0%	1%	25%	2%	0%	0%	0%	0%	0%	0%	0%	0%
Adj. Flow (vph)	11	631	18	135	590	9	4	2	186	13	2	8
Shared Lane Traffic (%)												
Lane Group Flow (vph)	11	649	0	135	599	0	0	192	0	0	23	0
Number of Detectors	1	2		1	2		1	1		1	1	
Detector Template	Left			Left			Left	Thru		Left	Thru	
Leading Detector (ft)	5	330		35	330		20	35		20	35	
Trailing Detector (ft)	0	0		-5	0		0	-5		0	-5	
Detector 1 Position(ft)	0	0		-5	0		0	-5		0	-5	
Detector 1 Size(ft)	5	6		40	6		20	40		20	40	
Detector 1 Type	Cl+Ex	Cl+Ex		Cl+Ex	Cl+Ex		Cl+Ex	Cl+Ex		Cl+Ex	Cl+Ex	
Detector 1 Channel												
Detector 1 Extend (s)	0.0	0.0		0.0	0.0		0.0	0.0		0.0	0.0	
Detector 1 Queue (s)	0.0	0.0		0.0	0.0		0.0	0.0		0.0	0.0	
Detector 1 Delay (s)	0.0	0.0		0.0	0.0		0.0	0.0		0.0	0.0	
Detector 2 Position(ft)		324			324							
Detector 2 Size(ft)		6			6							
Detector 2 Type		Cl+Ex			Cl+Ex							
Detector 2 Channel												
Detector 2 Extend (s)		0.0			0.0							
Turn Type	Perm	NA		pm+pt	NA		Perm	NA		Perm	NA	
Protected Phases		2		1	6			8			4	
Permitted Phases	2			6			8			4		
Detector Phase	2	2		1	6		8	8		4	4	
Switch Phase												
Minimum Initial (s)	15.0	15.0		3.0	15.0		7.0	7.0		7.0	7.0	
Minimum Split (s)	22.0	22.0		10.0	22.0		13.0	13.0		13.0	13.0	
Total Split (s)	61.0	61.0		14.0	75.0		25.0	25.0		25.0	25.0	
Total Split (%)	61.0%	61.0%		14.0%	75.0%		25.0%	25.0%		25.0%	25.0%	

BT Dreshertown, LP
 1: Jarrettown Road/Village Road & Welsh Road

2015 Existing SAT Peak



Lane Group	FBL	EBT	EBR	WBL	WBT	WBR	NBL	NBT	NBR	GBL	GBT	GBR
Maximum Green (s)	54.0	54.0		7.0	68.0		19.0	19.0		19.0	19.0	
Yellow Time (s)	5.0	5.0		5.0	5.0		4.0	4.0		4.0	4.0	
All-Red Time (s)	2.0	2.0		2.0	2.0		2.0	2.0		2.0	2.0	
Lost Time Adjust (s)	-1.0	-1.0		-1.0	-1.0			-1.0			-1.0	
Total Lost Time (s)	6.0	6.0		6.0	6.0			5.0			5.0	
Lead/Lag	Lag	Lag		Lead								
Lead-Lag Optimize?												
Vehicle Extension (s)	3.0	3.0		3.0	3.0		3.0	3.0		3.0	3.0	
Recall Mode	C-Max	C-Max		None	C-Max		None	None		None	None	

Intersection Summary

Area Type: Other
 Cycle Length: 100
 Actuated Cycle Length: 100
 Offset: 26 (26%), Referenced to phase 2:EBTL and 6:WBTL, Start of 1st Green
 Natural Cycle: 60
 Control Type: Actuated-Coordinated

Splits and Phases: 1: Jarrettown Road/Village Road & Welsh Road



BT Dreshertown, LP
 1: Jarrettown Road/Village Road & Welsh Road

2015 Existing SAT Peak



Movement	EBL	EBT	EBR	WBL	WBT	WBR	NBL	NBT	NBR	SBL	SBT	SBR
Lane Configurations	↖	↗		↖	↗			↕			↕	
Volume (veh/h)	10	574	16	123	537	8	4	2	169	12	2	7
Number	5	2	12	1	6	16	3	8	18	7	4	14
Initial Q (Qb), veh	0	0	0	0	0	0	0	0	0	0	0	0
Ped-Bike Adj(A_pbT)	1.00		1.00	1.00		1.00	1.00		1.00	1.00		1.00
Parking Bus, Adj	1.00	1.00	1.00	1.00	1.00	1.00	1.00	1.00	1.00	1.00	1.00	1.00
Adj Sat Flow, veh/h/ln	1854	1824	1854	1756	1863	1863	1809	1809	1809	1863	1863	1863
Adj Flow Rate, veh/h	11	631	17	135	590	9	4	2	88	13	2	3
Adj No. of Lanes	1	1	0	1	1	0	0	1	0	0	1	0
Peak Hour Factor	0.91	0.91	0.91	0.91	0.91	0.91	0.91	0.91	0.91	0.91	0.91	0.91
Percent Heavy Veh, %	0	1	1	2	0	0	0	0	0	0	0	0
Cap, veh/h	661	1214	33	566	1467	22	40	6	127	144	26	22
Arrive On Green	0.69	0.69	0.68	0.06	0.80	0.79	0.08	0.09	0.09	0.08	0.09	0.08
Sat Flow, veh/h	857	1768	48	1672	1830	28	29	69	1447	932	291	245
Grp Volume(v), veh/h	11	0	648	135	0	599	94	0	0	18	0	0
Grp Sat Flow(s),veh/h/ln	857	0	1815	1672	0	1858	1546	0	0	1468	0	0
Q Serve(g_s), s	0.4	0.0	17.4	2.0	0.0	9.4	1.7	0.0	0.0	0.0	0.0	0.0
Cycle Q Clear(g_c), s	0.4	0.0	17.4	2.0	0.0	9.4	5.9	0.0	0.0	1.0	0.0	0.0
Prop In Lane	1.00		0.03	1.00		0.02	0.04		0.94	0.72		0.17
Lane Grp Cap(c), veh/h	661	0	1247	566	0	1490	158	0	0	177	0	0
V/C Ratio(X)	0.02	0.00	0.52	0.24	0.00	0.40	0.59	0.00	0.00	0.10	0.00	0.00
Avail Cap(c_a), veh/h	661	0	1247	608	0	1490	330	0	0	339	0	0
HCM Platoon Ratio	1.00	1.00	1.00	1.00	1.00	1.00	1.00	1.00	1.00	1.00	1.00	1.00
Upstream Filter(I)	1.00	0.00	1.00	1.00	0.00	1.00	1.00	0.00	0.00	1.00	0.00	0.00
Uniform Delay (d), s/veh	5.0	0.0	7.6	5.2	0.0	2.9	44.3	0.0	0.0	42.4	0.0	0.0
Incr Delay (d2), s/veh	0.0	0.0	1.6	0.2	0.0	0.8	3.5	0.0	0.0	0.2	0.0	0.0
Initial Q Delay(d3),s/veh	0.0	0.0	0.0	0.0	0.0	0.0	0.0	0.0	0.0	0.0	0.0	0.0
%ile BackOfQ(95%),veh/ln	0.2	0.0	14.2	1.7	0.0	8.7	4.9	0.0	0.0	0.9	0.0	0.0
LnGrp Delay(d),s/veh	5.0	0.0	9.2	5.4	0.0	3.7	47.8	0.0	0.0	42.7	0.0	0.0
LnGrp LOS	A		A	A		A	D			D		
Approach Vol, veh/h		659			734			94			18	
Approach Delay, s/veh		9.1			4.0			47.8			42.7	
Approach LOS		A			A			D			D	

Time:	1	2	3	4	5	6	7	8
Assigned Phs	1	2		4		6		8
Phs Duration (G+Y+Rc), s	11.5	74.7		13.8		86.2		13.8
Change Period (Y+Rc), s	7.0	7.0		6.0		7.0		6.0
Max Green Setting (Gmax), s	7.0	54.0		19.0		68.0		19.0
Max Q Clear Time (g_c+I1), s	4.5	19.4		3.0		11.4		7.9
Green Ext Time (p_c), s	0.1	25.4		0.3		35.9		0.2

Intersection Summary	
HCM 2010 Ctrl Delay	9.5
HCM 2010 LOS	A

BT Dreshertown, LP
2: Welsh Road & Dresher Road

2015 Existing SAT Peak

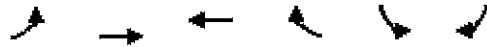

Lane Group	EBL	EBT	WBT	WER	SBL	SBR
Lane Configurations		↕↕	↕↕	↕	↕↕	↕
Volume (vph)	124	663	585	345	311	119
Ideal Flow (vphpl)	1800	1800	1800	1800	1800	1800
Lane Width (ft)	12	12	11	11	12	13
Grade (%)		-1%	1%		1%	
Storage Length (ft)	0			210	0	415
Storage Lanes	0			1	2	1
Taper Length (ft)	75				75	
Lane Util. Factor	0.95	0.95	0.95	1.00	0.97	1.00
Fr _t				0.850		0.850
Flt Protected		0.992			0.950	
Satd. Flow (prot)	0	3371	3257	1472	3301	1542
Flt Permitted		0.701			0.950	
Satd. Flow (perm)	0	2382	3257	1472	3301	1542
Right Turn on Red				Yes		Yes
Satd. Flow (RTOR)				371		128
Link Speed (mph)		45	45		35	
Link Distance (ft)		475	550		970	
Travel Time (s)		7.2	8.3		18.9	
Peak Hour Factor	0.93	0.93	0.93	0.93	0.93	0.93
Heavy Vehicles (%)	2%	1%	1%	0%	0%	2%
Adj. Flow (vph)	133	713	629	371	334	128
Shared Lane Traffic (%)						
Lane Group Flow (vph)	0	846	629	371	334	128
Number of Detectors	1	1	1	1	1	1
Detector Template						
Leading Detector (ft)	35	5	5	5	35	35
Trailing Detector (ft)	-5	0	0	0	-5	-5
Detector 1 Position(ft)	-5	0	0	0	-5	-5
Detector 1 Size(ft)	40	5	5	5	40	40
Detector 1 Type	Cl+Ex	Cl+Ex	Cl+Ex	Cl+Ex	Cl+Ex	Cl+Ex
Detector 1 Channel						
Detector 1 Extend (s)	0.0	0.0	0.0	0.0	0.0	0.0
Detector 1 Queue (s)	0.0	0.0	0.0	0.0	0.0	0.0
Detector 1 Delay (s)	0.0	0.0	0.0	0.0	0.0	0.0
Turn Type	pm+pt	NA	NA	pm+ov	Prot	pm+ov
Protected Phases	5	2	6	4	4	5
Permitted Phases	2			6		4
Detector Phase	5	2	6	4	4	5
Switch Phase						
Minimum Initial (s)	3.0	20.0	20.0	7.0	7.0	3.0
Minimum Split (s)	9.0	26.0	26.0	14.0	14.0	9.0
Total Split (s)	14.0	70.0	56.0	30.0	30.0	14.0
Total Split (%)	14.0%	70.0%	56.0%	30.0%	30.0%	14.0%
Maximum Green (s)	8.0	64.0	50.0	23.0	23.0	8.0
Yellow Time (s)	4.0	4.0	4.0	4.0	4.0	4.0
All-Red Time (s)	2.0	2.0	2.0	3.0	3.0	2.0
Lost Time Adjust (s)		-1.0	-1.0	-1.0	-1.0	-1.0
Total Lost Time (s)		5.0	5.0	6.0	6.0	5.0

BT Dreshertown, LP
2: Welsh Road & Dresher Road

2015 Existing SAT Peak

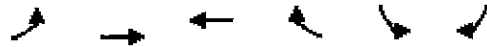

Lane Group	EBL	EBT	WBT	WBR	SBL	SBR
Lead/Lag	Lead		Lag		Lead	
Lead-Lag Optimize?						
Vehicle Extension (s)	3.0	3.0	3.0	3.0	3.0	3.0
Recall Mode	None	C-Max	C-Max	None	None	None
Act Effct Green (s)		71.9	60.2	82.3	17.1	29.8
Actuated g/C Ratio		0.72	0.60	0.82	0.17	0.30
v/c Ratio		0.48	0.32	0.29	0.59	0.23
Control Delay		4.8	11.7	2.7	42.1	5.4
Queue Delay		0.0	0.0	0.0	0.0	0.0
Total Delay		4.8	11.7	2.7	42.1	5.4
LOS		A	B	A	D	A
Approach Delay		4.8	8.4		32.0	
Approach LOS		A	A		C	
Queue Length 50th (ft)		55	123	27	102	0
Queue Length 95th (ft)		92	167	30	138	38
Internal Link Dist (ft)		395	470		890	
Turn Bay Length (ft)				210		415
Base Capacity (vph)		1778	1960	1353	792	582
Starvation Cap Reductn		0	0	0	0	0
Spillback Cap Reductn		0	0	0	0	0
Storage Cap Reductn		0	0	0	0	0
Reduced v/c Ratio		0.48	0.32	0.27	0.42	0.22

Intersection Summary

Area Type: Other
 Cycle Length: 100
 Actuated Cycle Length: 100
 Offset: 38 (38%), Referenced to phase 2:EBTL and 6:WBT, Start of 1st Green
 Natural Cycle: 50
 Control Type: Actuated-Coordinated
 Maximum v/c Ratio: 0.59
 Intersection Signal Delay: 11.8
 Intersection Capacity Utilization 62.9%
 Analysis Period (min) 15

Intersection LOS: B
ICU Level of Service B

Splits and Phases: 2: Welsh Road & Dresher Road

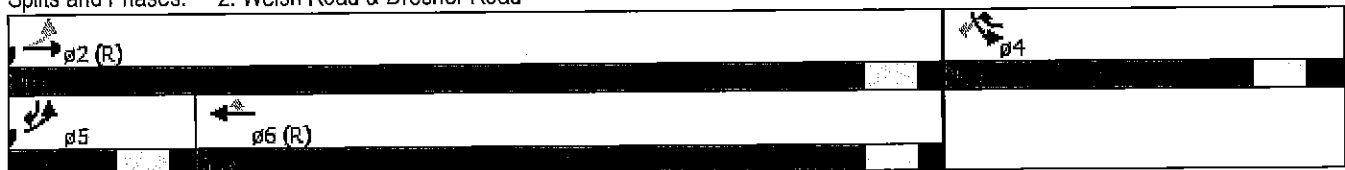



Lane Group	EBT	EBR	WBL	WBT	NBL	NBR
Lane Configurations	↑↑		↓	↑↑	↑↓	↑
Volume (vph)	817	157	240	776	154	291
Ideal Flow (vphpl)	1800	1800	1800	1800	1800	1800
Lane Width (ft)	12	12	10	12	12	15
Grade (%)	-2%			1%	1%	
Storage Length (ft)		0	175		0	350
Storage Lanes		0	1		2	2
Taper Length (ft)			75		75	
Lane Util. Factor	0.95	0.95	1.00	0.95	0.97	1.00
Frt	0.976					0.850
Flt Protected			0.950		0.950	
Satd. Flow (prot)	3366	0	1588	3403	3301	1675
Flt Permitted			0.180		0.950	
Satd. Flow (perm)	3366	0	301	3403	3301	1675
Right Turn on Red		Yes				Yes
Satd. Flow (RTOR)	27					63
Link Speed (mph)	45			45	40	
Link Distance (ft)	550			1040	778	
Travel Time (s)	8.3			15.8	13.3	
Peak Hour Factor	0.91	0.91	0.91	0.91	0.91	0.91
Heavy Vehicles (%)	0%	1%	0%	0%	0%	0%
Adj. Flow (vph)	898	173	264	853	169	320
Shared Lane Traffic (%)						
Lane Group Flow (vph)	1071	0	264	853	169	320
Number of Detectors	1		1	1	1	1
Detector Template						
Leading Detector (ft)	5		35	5	35	35
Trailing Detector (ft)	0		-5	0	-5	-5
Detector 1 Position(ft)	0		-5	0	-5	-5
Detector 1 Size(ft)	5		40	5	40	40
Detector 1 Type	CI+Ex		CI+Ex	CI+Ex	CI+Ex	CI+Ex
Detector 1 Channel						
Detector 1 Extend (s)	0.0		0.0	0.0	0.0	0.0
Detector 1 Queue (s)	0.0		0.0	0.0	0.0	0.0
Detector 1 Delay (s)	0.0		0.0	0.0	0.0	0.0
Turn Type	NA		pm+pt	NA	Prot	pm+ov
Protected Phases	2		1	6	8	1
Permitted Phases			6			8
Detector Phase	2		1	6	8	1
Switch Phase						
Minimum Initial (s)	20.0		3.0	20.0	7.0	3.0
Minimum Split (s)	27.0		10.0	27.0	14.0	10.0
Total Split (s)	48.0		27.0	75.0	25.0	27.0
Total Split (%)	48.0%		27.0%	75.0%	25.0%	27.0%
Maximum Green (s)	41.0		20.0	68.0	18.0	20.0
Yellow Time (s)	5.0		5.0	5.0	4.0	5.0
All-Red Time (s)	2.0		2.0	2.0	3.0	2.0
Lost Time Adjust (s)	-1.0		-1.0	-1.0	-1.0	-1.0
Total Lost Time (s)	6.0		6.0	6.0	6.0	6.0

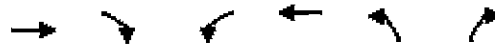

Lane Group	EBT	EBR	WBL	WBT	NBL	NBR
Lead/Lag	Lag		Lead		Lead	
Lead-Lag Optimize?						
Vehicle Extension (s)	3.0		3.0	3.0	3.0	3.0
Recall Mode	C-Max		None	C-Max	None	None

Intersection Summary

Area Type: Other
 Cycle Length: 100
 Actuated Cycle Length: 100
 Offset: 28 (28%), Referenced to phase 2:EBT and 6:WBTL, Start of 1st Green
 Natural Cycle: 60
 Control Type: Actuated-Coordinated

Splits and Phases: 3: Dreshertown Road & Welsh Road

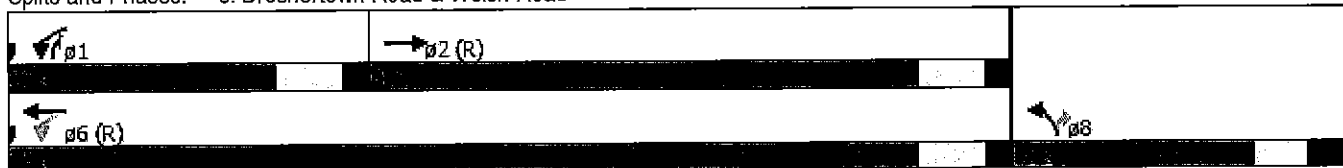

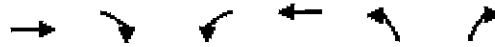

Movement	EBT	EBR	WBL	WBT	NBL	NBR
Lane Configurations	↑↑		↑	↑↑	↑↑	↑
Volume (veh/h)	817	157	240	776	154	291
Number	2	12	1	6	3	18
Initial Q (Qb), veh	0	0	0	0	0	0
Ped-Bike Adj(A_pbT)		1.00	1.00		1.00	1.00
Parking Bus, Adj	1.00	1.00	1.00	1.00	1.00	1.00
Adj Sat Flow, veh/h/ln	1815	1818	1791	1791	1791	1863
Adj Flow Rate, veh/h	898	173	264	853	169	234
Adj No. of Lanes	2	0	1	2	2	1
Peak Hour Factor	0.91	0.91	0.91	0.91	0.91	0.91
Percent Heavy Veh, %	0	0	0	0	0	0
Cap, veh/h	1585	305	543	2429	550	429
Arrive On Green	1.00	1.00	0.21	1.00	0.17	0.17
Sat Flow, veh/h	2976	556	1706	3492	3309	1583
Grp Volume(v), veh/h	536	535	264	853	169	234
Grp Sat Flow(s),veh/h/ln	1724	1717	1706	1701	1655	1583
Q Serve(g_s), s	0.0	0.0	6.4	0.0	4.5	12.6
Cycle Q Clear(g_c), s	0.0	0.0	6.4	0.0	4.5	12.6
Prop In Lane		0.32	1.00		1.00	1.00
Lane Grp Cap(c), veh/h	947	943	543	2429	550	429
V/C Ratio(X)	0.57	0.57	0.49	0.35	0.31	0.55
Avail Cap(c_a), veh/h	947	943	723	2429	629	467
HCM Platoon Ratio	2.00	2.00	2.00	2.00	1.00	1.00
Upstream Filter(I)	0.85	0.85	0.95	0.95	1.00	1.00
Uniform Delay (d), s/veh	0.0	0.0	5.5	0.0	36.6	31.2
Incr Delay (d2), s/veh	2.1	2.1	0.6	0.4	0.3	1.1
Initial Q Delay(d3),s/veh	0.0	0.0	0.0	0.0	0.0	0.0
%ile BackOfQ(95%),veh/ln	1.0	1.0	5.3	0.2	3.7	9.5
LnGrp Delay(d),s/veh	2.1	2.1	6.1	0.4	37.0	32.3
LnGrp LOS	A	A	A	A	D	C
Approach Vol, veh/h	1071			1117	403	
Approach Delay, s/veh	2.1			1.7	34.2	
Approach LOS	A			A	C	

Timer	1	2	3	4	5	6	7	8
Assigned Phs	1	2				6		8
Phs Duration (G+Y+Rc), s	16.5	60.9				77.4		22.6
Change Period (Y+Rc), s	7.0	7.0				7.0		7.0
Max Green Setting (Gmax), s	20.0	41.0				68.0		18.0
Max Q Clear Time (g_c+I1), s	8.9	2.5				2.5		15.1
Green Ext Time (p_c), s	0.6	6.7				6.8		0.5

Intersection Summary	
HCM 2010 Ctrl Delay	6.9
HCM 2010 LOS	A

BT Dreshertown, LP
4: Dryden Road & Welsh Road

2015 Existing SAT Peak



Lane Group	EBL	EBT	EBR	WBL	WBT	WBR	NEL	NBT	NBR	SBL	SBT	SBR
Lane Configurations												
Volume (vph)	2	1049	3	1	1027	2	1	0	1	2	0	2
Ideal Flow (vphpl)	1800	1800	1800	1800	1800	1800	1800	1800	1800	1800	1800	1800
Lane Width (ft)	10	12	14	10	12	12	11	15	15	12	14	14
Grade (%)		-1%			-1%			-1%			0%	
Storage Length (ft)	150		225	175		0	110		0	150		0
Storage Lanes	1		1	1		0	1		0	1		0
Taper Length (ft)	75			75			75			75		
Lane Util. Factor	1.00	0.95	1.00	1.00	0.95	0.95	1.00	1.00	1.00	1.00	1.00	1.00
Frt			0.850					0.850			0.850	
Flt Protected	0.950			0.950			0.950			0.950		
Satd. Flow (prot)	1604	3437	1640	1604	3437	0	1661	1691	0	1710	1632	0
Flt Permitted	0.245			0.239								
Satd. Flow (perm)	414	3437	1640	404	3437	0	1749	1691	0	1800	1632	0
Right Turn on Red			Yes			Yes			Yes			Yes
Satd. Flow (RTOR)			33					97			103	
Link Speed (mph)		45			45			25			25	
Link Distance (ft)		1040			1416			754			960	
Travel Time (s)		15.8			21.5			20.6			26.2	
Peak Hour Factor	0.90	0.90	0.90	0.90	0.90	0.90	0.90	0.90	0.90	0.90	0.90	0.90
Heavy Vehicles (%)	0%	0%	0%	0%	0%	0%	0%	0%	0%	0%	0%	0%
Adj. Flow (vph)	2	1166	3	1	1141	2	1	0	1	2	0	2
Shared Lane Traffic (%)												
Lane Group Flow (vph)	2	1166	3	1	1143	0	1	1	0	2	2	0
Number of Detectors	1	1	1	1	1		1	1		1	1	
Detector Template												
Leading Detector (ft)	5	5	5	5	5		35	35		35	35	
Trailing Detector (ft)	0	0	0	0	0		-5	-5		-5	-5	
Detector 1 Position(ft)	0	0	0	0	0		-5	-5		-5	-5	
Detector 1 Size(ft)	5	5	5	5	5		40	40		40	40	
Detector 1 Type	Cl+Ex	Cl+Ex	Cl+Ex	Cl+Ex	Cl+Ex		Cl+Ex	Cl+Ex		Cl+Ex	Cl+Ex	
Detector 1 Channel												
Detector 1 Extend (s)	0.0	0.0	0.0	0.0	0.0		0.0	0.0		0.0	0.0	
Detector 1 Queue (s)	0.0	0.0	0.0	0.0	0.0		0.0	0.0		0.0	0.0	
Detector 1 Delay (s)	0.0	0.0	0.0	0.0	0.0		0.0	0.0		0.0	0.0	
Turn Type	Perm	NA	Perm	Perm	NA		Perm	NA		Perm	NA	
Protected Phases		2			6			8			4	
Permitted Phases	2		2	6			8			4		4
Detector Phase	2	2	2	6	6		8	8		4	4	
Switch Phase												
Minimum Initial (s)	21.0	21.0	21.0	21.0	21.0		5.0	5.0		5.0	5.0	
Minimum Split (s)	27.0	27.0	27.0	27.0	27.0		11.0	11.0		11.0	11.0	
Total Split (s)	69.0	69.0	69.0	69.0	69.0		31.0	31.0		31.0	31.0	
Total Split (%)	69.0%	69.0%	69.0%	69.0%	69.0%		31.0%	31.0%		31.0%	31.0%	
Maximum Green (s)	63.0	63.0	63.0	63.0	63.0		25.0	25.0		25.0	25.0	
Yellow Time (s)	4.0	4.0	4.0	4.0	4.0		3.0	3.0		3.0	3.0	
All-Red Time (s)	2.0	2.0	2.0	2.0	2.0		3.0	3.0		3.0	3.0	
Lost Time Adjust (s)	-1.0	-1.0	-1.0	-1.0	-1.0		-1.0	-1.0		-1.0	-1.0	
Total Lost Time (s)	5.0	5.0	5.0	5.0	5.0		5.0	5.0		5.0	5.0	

BT Dreshertown, LP
 4: Dryden Road & Welsh Road

2015 Existing SAT Peak



Lane Group	EBL	EBT	EBR	WBL	WBT	WBR	NBL	NBT	NBR	SBL	SBT	SBR
Lead/Lag												
Lead-Lag Optimize?												
Vehicle Extension (s)	3.0	3.0	3.0	3.0	3.0		3.0	3.0		3.0	3.0	
Recall Mode	C-Max	C-Max	C-Max	C-Max	C-Max		None	None		None	None	

Intersection Summary

Area Type: Other
 Cycle Length: 100
 Actuated Cycle Length: 100
 Offset: 41 (41%), Referenced to phase 2:EBTL and 6:WBTL, Start of 1st Green
 Natural Cycle: 40
 Control Type: Actuated-Coordinated

Splits and Phases: 4: Dryden Road & Welsh Road

ø2 (R)	ø4
ø5 (R)	ø8

BT Dreshertown, LP
4: Dryden Road & Welsh Road

2015 Existing SAT Peak

Movement	EBL	EBT	EBR	WBL	WBT	WBR	NBL	NBT	NBR	SBL	SBT	GBR
Lane Configurations												
Volume (veh/h)	2	1049	3	1	1027	2	1	0	1	2	0	2
Number	5	2	12	1	6	16	3	8	18	7	4	14
Initial Q (Qb), veh	0	0	0	0	0	0	0	0	0	0	0	0
Ped-Bike Adj(A_pbT)	1.00		1.00	1.00		1.00	1.00		1.00	1.00		1.00
Parking Bus, Adj	1.00	1.00	1.00	1.00	1.00	1.00	1.00	1.00	1.00	1.00	1.00	1.00
Adj Sat Flow, veh/h/ln	1809	1809	1881	1809	1809	1809	1809	1881	1881	1800	1872	1872
Adj Flow Rate, veh/h	2	1166	1	1	1141	2	1	0	1	2	0	2
Adj No. of Lanes	1	2	1	1	2	0	1	1	0	1	1	0
Peak Hour Factor	0.90	0.90	0.90	0.90	0.90	0.90	0.90	0.90	0.90	0.90	0.90	0.90
Percent Heavy Veh, %	0	0	0	0	0	0	0	0	0	0	0	0
Cap, veh/h	487	3033	1411	505	3106	5	98	0	28	97	0	28
Arrive On Green	1.00	1.00	1.00	0.88	0.88	0.87	0.02	0.00	0.01	0.02	0.00	0.01
Sat Flow, veh/h	502	3437	1599	491	3520	6	1445	0	1599	1439	0	1591
Grp Volume(v), veh/h	2	1166	1	1	557	586	1	0	1	2	0	2
Grp Sat Flow(s),veh/h/ln	502	1719	1599	491	1719	1808	1445	0	1599	1439	0	1591
Q Serve(g_s), s	0.0	0.0	0.0	0.0	5.6	5.6	0.1	0.0	0.1	0.1	0.0	0.1
Cycle Q Clear(g_c), s	5.7	0.0	0.0	0.0	5.6	5.6	0.1	0.0	0.1	0.1	0.0	0.1
Prop In Lane	1.00		1.00	1.00		0.00	1.00		1.00	1.00		1.00
Lane Grp Cap(c), veh/h	487	3033	1411	505	1516	1595	98	0	28	97	0	28
V/C Ratio(X)	0.00	0.38	0.00	0.00	0.37	0.37	0.01	0.00	0.04	0.02	0.00	0.07
Avail Cap(c_a), veh/h	487	3033	1411	505	1516	1595	448	0	416	446	0	414
HCM Platoon Ratio	2.00	2.00	2.00	1.00	1.00	1.00	1.00	1.00	1.00	1.00	1.00	1.00
Upstream Filter(I)	0.80	0.80	0.80	1.00	1.00	1.00	1.00	0.00	1.00	1.00	0.00	1.00
Uniform Delay (d), s/veh	0.2	0.0	0.0	0.7	1.0	1.0	48.3	0.0	48.8	48.3	0.0	48.8
Incr Delay (d2), s/veh	0.0	0.3	0.0	0.0	0.7	0.7	0.0	0.0	0.5	0.1	0.0	1.1
Initial Q Delay(d3),s/veh	0.0	0.0	0.0	0.0	0.0	0.0	0.0	0.0	0.0	0.0	0.0	0.0
%ile BackOfQ(95%),veh/ln	0.0	0.2	0.0	0.0	5.0	5.2	0.1	0.0	0.1	0.1	0.0	0.1
LnGrp Delay(d),s/veh	0.2	0.3	0.0	0.7	1.7	1.7	48.3	0.0	49.3	48.4	0.0	49.9
LnGrp LOS	A	A	A	A	A	A	D		D	D		D
Approach Vol, veh/h		1169			1144			2				4
Approach Delay, s/veh		0.3			1.7			48.8				49.1
Approach LOS		A			A			D				D
Timer	1	2	3	4	5	6	7	8				
Assigned Phs		2		4		6		8				
Phs Duration (G+Y+Rc), s		93.2		6.8		93.2		6.8				
Change Period (Y+Rc), s		6.0		6.0		6.0		6.0				
Max Green Setting (Gmax), s		63.0		25.0		63.0		25.0				
Max Q Clear Time (g_c+I1), s		8.2		2.6		8.1		2.6				
Green Ext Time (p_c), s		9.3		0.0		9.3		0.0				
Intersection Summary												
HCM 2010 Ctrl Delay				1.1								
HCM 2010 LOS				A								

APPENDIX F

Other Development

BMJ 12/04/2015

"OTHER" DEVELOPMENT TRIP GENERATION

Age Restricted Housing Development
 I:\eng\815367\TrafficAnalysis\SDS\SDS Design Year 2023 Residential and Office (Approved)
 2023

TRIP VOLUMES

Land Use	Pass-By (%)			Size	Daily	Weekday 7-9 AM			Weekday 4-6 PM			Saturday 11-2 PM		
	AM	PM	SAT			In	Out	Total	In	Out	Total	In	Out	Total
FW Triangle - Upper Dublin	AM	PM	SAT	Sq. Ft.	0	48	45	93	52	37	89	55	49	104
- Pass-By Trips (%)	0	0	0	--	0	11	11	22	14	14	28	15	15	30
"New" Trips					0	37	34	71	38	23	61	40	34	74
Zieger Rose - Upper Dublin	AM	PM	SAT	Sq. Ft.	0	17	31	48	29	18	47	12	12	24
- Pass-By Trips (%)	0	0	0	--	0	0	0	0	0	0	0	0	0	0
"New" Trips					0	17	31	48	29	18	47	12	12	24
Wawa Retail Site - Horsham	AM	PM	SAT	Sq. Ft.	0	225	208	433	256	232	488	272	255	527
- Pass-By Trips (%)	0	0	0	--	0	109	109	218	141	141	282	118	118	236
"New" Trips					0	116	99	215	115	91	206	154	137	291
Single Family Homes - Horsha	AM	PM	SAT	Sq. Ft.	0	3	8	11	9	6	15	8	6	14
- Pass-By Trips (%)	0	0	0	--	0	0	0	0	0	0	0	0	0	0
"New" Trips					0	3	8	11	9	6	15	8	6	14
Horsham Apartments	AM	PM	SAT	Sq. Ft.	0	25	101	126	101	54	155	61	61	122
- Pass-By Trips (%)	0	0	0	--	0	0	0	0	0	0	0	0	0	0
"New" Trips					0	25	101	126	101	54	155	61	61	122
- Pass-By Trips (%)	AM	PM	SAT	Sq. Ft.										
"New" Trips	0	0	0	--										
- Pass-By Trips (%)	AM	PM	SAT	Sq. Ft.										
"New" Trips	0	0	0	--										
- Pass-By Trips (%)	AM	PM	SAT	Sq. Ft.										
"New" Trips	0	0	0	--										
TOTAL TRIPS:					0	318	393	711	447	347	794	408	383	791
Other Adjustments	AM	PM	SAT	%	0	0	0	0	0	0	0	0	0	0
- Pass-By Trips	0	0	0		0	120	120	240	155	155	310	133	133	266
TOTAL EXTERNAL "NEW" TRIPS:					0	198	273	471	292	192	484	275	250	625

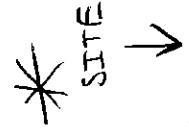
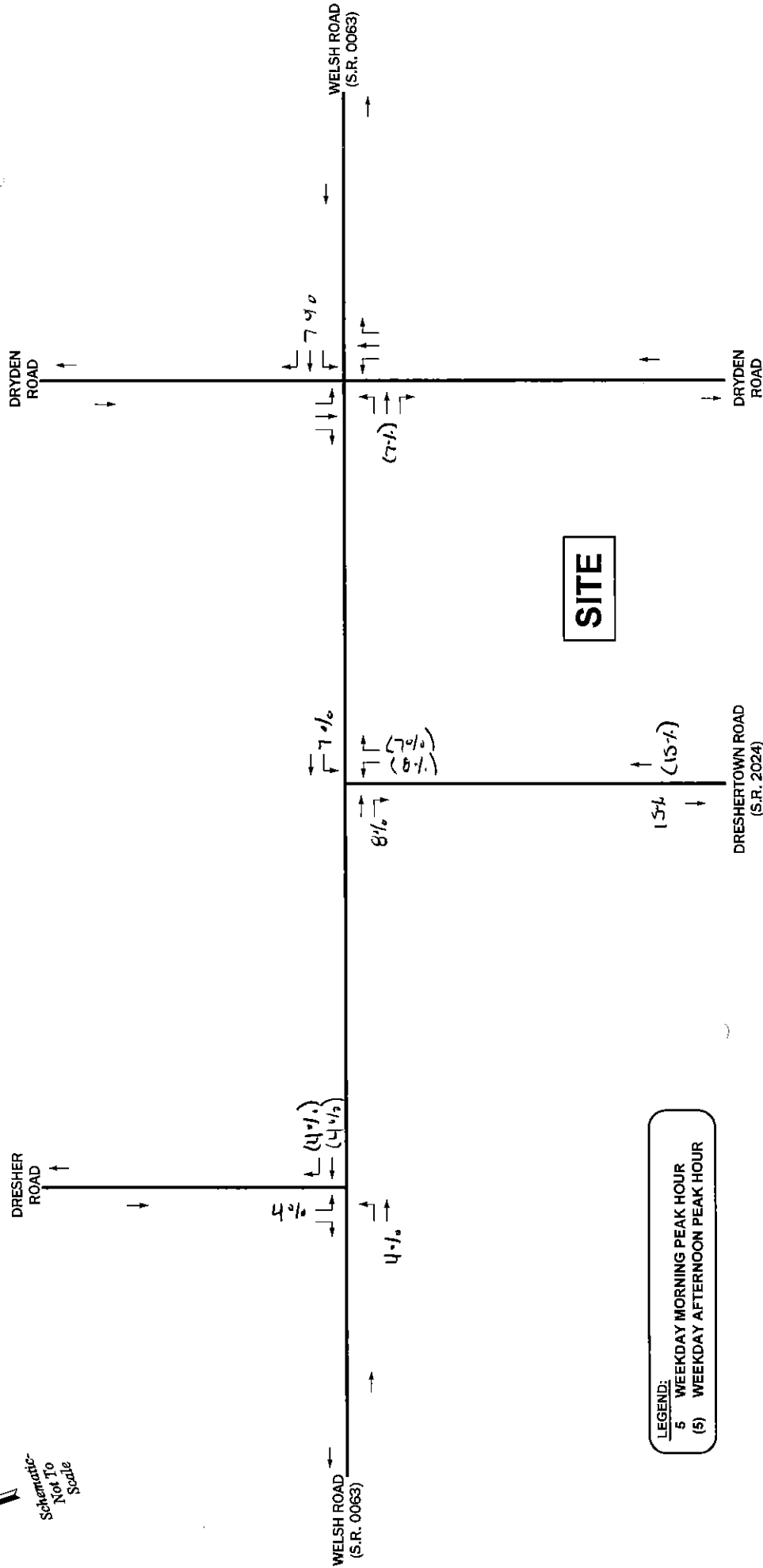
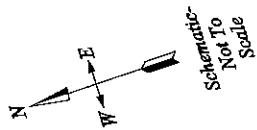

FIGURE
FU Triangle Development

UPPER DUBLIN TOWNSHIP, MONTGOMERY COUNTY, PA

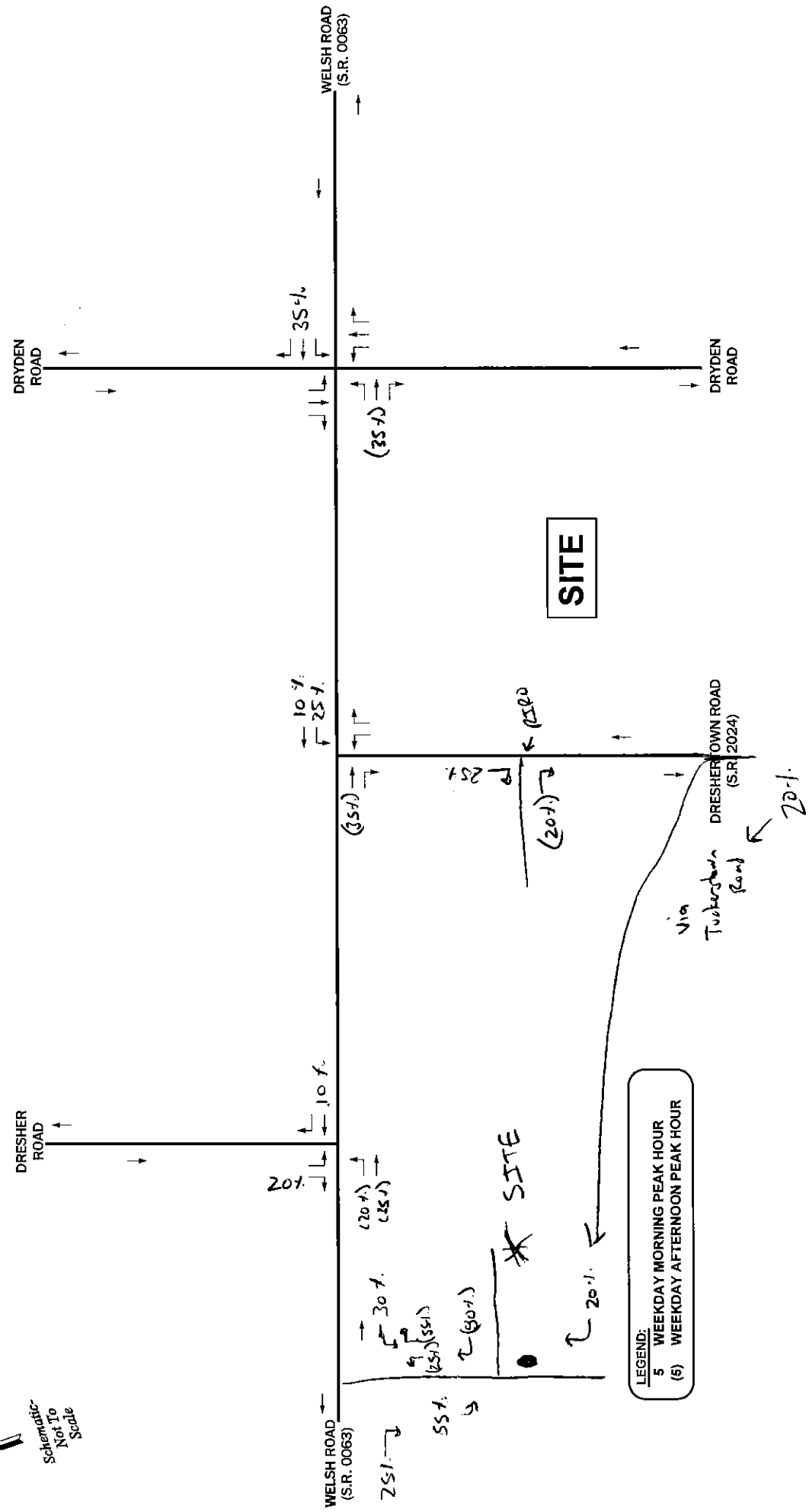
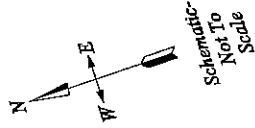
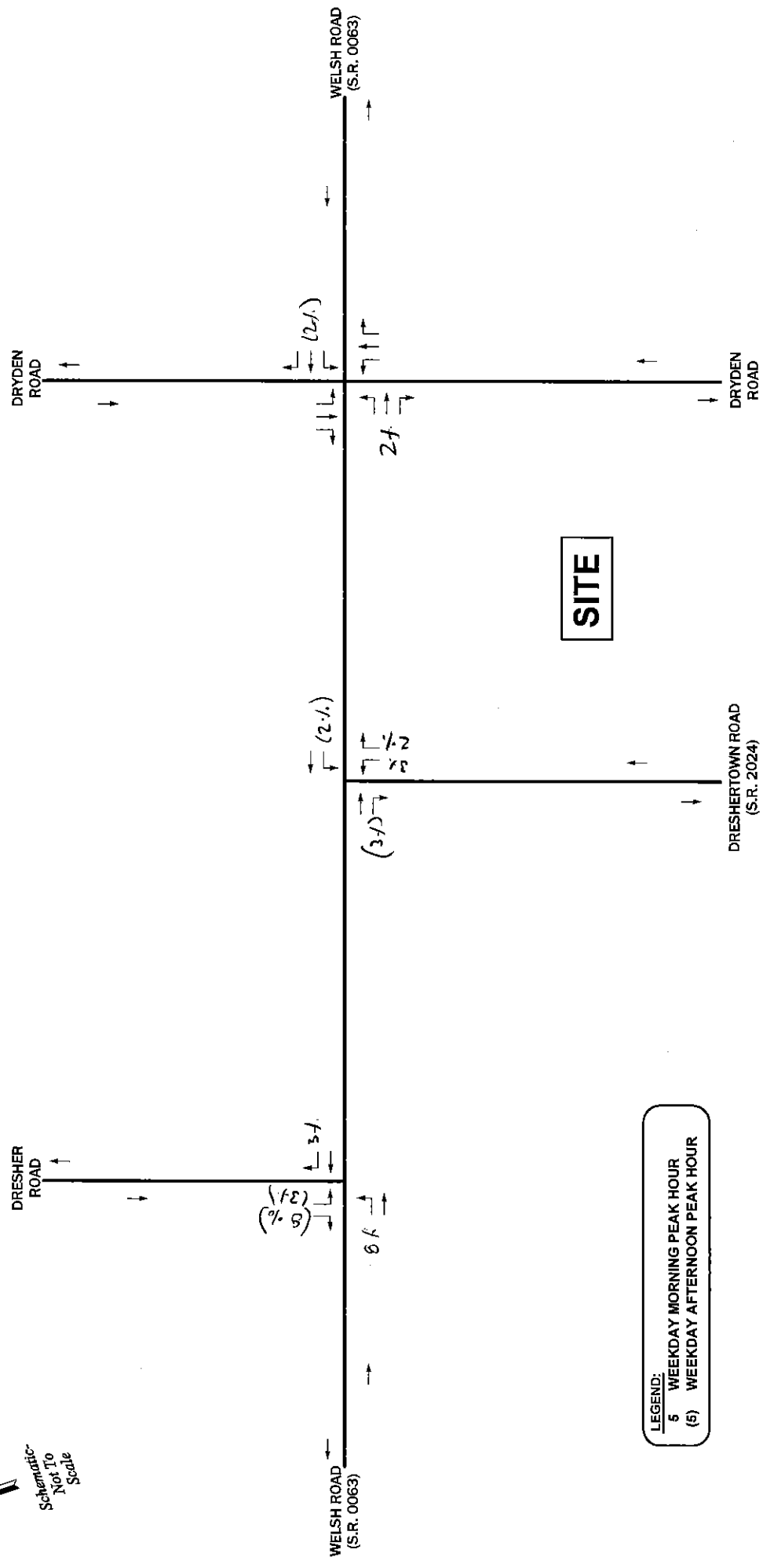
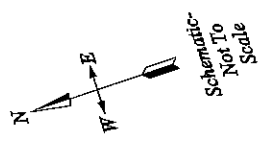

FIGURE
Ziggy Rose

Horsham Retail



FIGURE

Horsham Retail Center

~~***~~
SITE

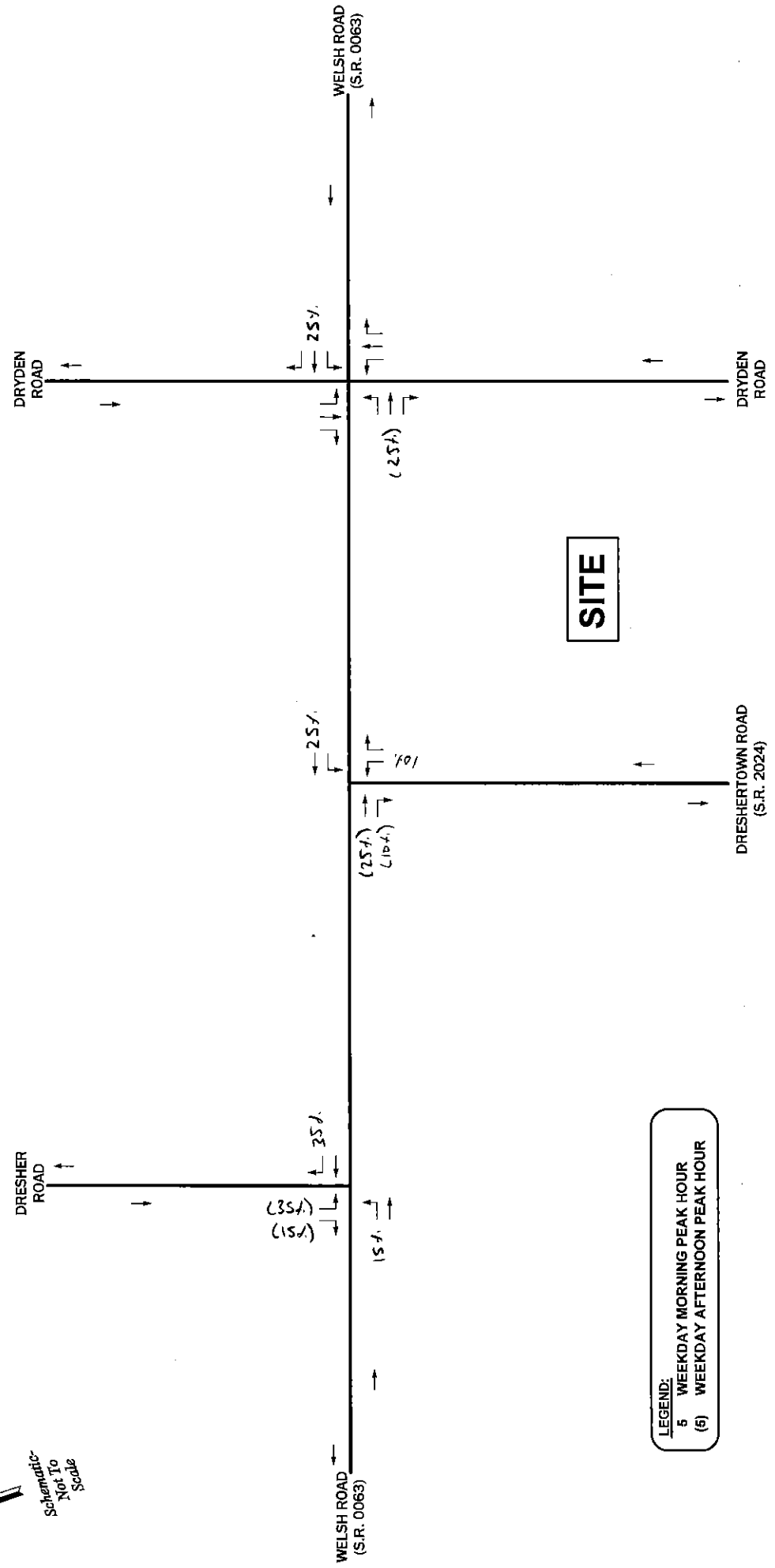
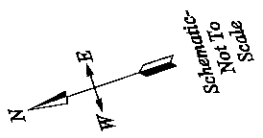

FIGURE

15 Single Family Homes + BEI Apartments - Hosham

UPPER DUBLIN TOWNSHIP, MONTGOMERY COUNTY, PA

APPENDIX G

Traffic Volume Spreadsheets

INTERSECTION VOLUME SUMMARY
Dresher Road/Welsh Road (S.R. 0063)

Age Restricted Housing Development
 I:\eng\815367\Traffic\Analysis\SDS\SDS Opening Year 2018 Residential (Proposed F Weekday 7-9 AM
 2018

Traffic Component	EASTBOUND Welsh Road (S.R. 0063)			NORTHBOUND Dresher Road			WESTBOUND Welsh Road (S.R. 0063)			SOUTHBOUND Dresher Road		
	L	S	R	L	S	R	L	S	R	L	S	R
EXISTING TRAFFIC	387	803	0	0	0	0	0	688	568	621	0	278
Seasonal Adjustment Factor 1.000	387	803	0	0	0	0	0	688	568	621	0	278
Balancing Adjustments	0	0	0	0	0	0	0	0	0	0	0	0
ADJUSTED EXISTING TRAFFIC	387	803	0	0	0	0	0	688	568	621	0	278
Background Growth 1.93 %	7	16	0	0	0	0	0	13	11	12	0	5
EXISTING W/ BACKGROUND	394	819	0	0	0	0	0	701	579	633	0	283
TOTAL "OTHER" DEVELOPMENTS	19	12	0	0	0	0	0	3	14	42	0	27
FW Triangle - Upper Dublin	0	1	0	0	0	0	0	1	1	1	0	0
Zieger Rose - Upper Dublin	6	11	0	0	0	0	0	2	0	0	0	3
Wawa Retail Site - Horsham	9	0	0	0	0	0	0	0	3	3	0	8
Single Family Homes - Horsham	0	0	0	0	0	0	0	0	1	3	0	1
Horsham Apartments	4	0	0	0	0	0	0	0	9	35	0	15
Other Adjustments	0	0	0	0	0	0	0	0	0	0	0	0
FUTURE TRAFFIC W/O PROJECT	413	831	0	0	0	0	0	704	593	675	0	310
TOTAL "NEW" SITE TRAFFIC	0	4	0	0	0	0	0	8	6	4	0	0
BT Dreshertown, LP	0	4	0	0	0	0	0	8	6	4	0	0
	0	0	0	0	0	0	0	0	0	0	0	0
	0	0	0	0	0	0	0	0	0	0	0	0
	0	0	0	0	0	0	0	0	0	0	0	0
	0	0	0	0	0	0	0	0	0	0	0	0
	0	0	0	0	0	0	0	0	0	0	0	0
	0	0	0	0	0	0	0	0	0	0	0	0
Pass-By Traffic	0	0	0	0	0	0	0	0	0	0	0	0
Other Adjustments	0	0	0	0	0	0	0	0	0	0	0	0
FUTURE TRAFFIC W/ PROJECT	413	835	0	0	0	0	0	712	599	679	0	310
"New" Site Traffic % of Total 0.0%	0.0	0.5	0.0	0.0	0.0	0.0	0.0	1.1	1.0	0.6	0.0	0.0

INTERSECTION VOLUME SUMMARY
Dresher Road/Welsh Road (S.R. 0063)

Age Restricted Housing Development
 I:\eng\815367\Traffic\Analysis\SDS\SDS Opening Year 2018 Residential (Proposed P. Weekday 4-6 PM
 2018

Traffic Component	EASTBOUND Welsh Road (S.R. 0063)			NORTHBOUND Dresher Road			WESTBOUND Welsh Road (S.R. 0063)			SOUTHBOUND Dresher Road		
	L	S	R	L	S	R	L	S	R	L	S	R
EXISTING TRAFFIC	272	820	0	0	0	0	0	881	527	819	0	384
Seasonal Adjustment Factor 1.000	272	820	0	0	0	0	0	881	527	819	0	384
Balancing Adjustments	0	0	0	0	0	0	0	0	0	0	0	0
ADJUSTED EXISTING TRAFFIC	272	820	0	0	0	0	0	881	527	819	0	384
Background Growth 1.93 %	5	16	0	0	0	0	0	17	10	16	0	7
EXISTING W/ BACKGROUND	277	836	0	0	0	0	0	898	537	835	0	391
TOTAL "OTHER" DEVELOPMENTS	29	8	0	0	0	0	0	4	42	26	0	22
FW Triangle - Upper Dublin	0	2	0	0	0	0	0	1	1	2	0	0
Zieger Rose - Upper Dublin	4	6	0	0	0	0	0	3	0	0	0	6
Wawa Retail Site - Horsham	9	0	0	0	0	0	0	0	3	3	0	7
Single Family Homes - Horsham	1	0	0	0	0	0	0	0	3	2	0	1
Horsham Apartments	15	0	0	0	0	0	0	0	35	19	0	8
Other Adjustments	0	0	0	0	0	0	0	0	0	0	0	0
FUTURE TRAFFIC W/O PROJECT	306	844	0	0	0	0	0	902	579	861	0	413
TOTAL "NEW" SITE TRAFFIC	0	8	0	0	0	0	0	5	4	6	0	0
BT Dreshertown, LP	0	8	0	0	0	0	0	5	4	6	0	0
	0	0	0	0	0	0	0	0	0	0	0	0
	0	0	0	0	0	0	0	0	0	0	0	0
	0	0	0	0	0	0	0	0	0	0	0	0
	0	0	0	0	0	0	0	0	0	0	0	0
	0	0	0	0	0	0	0	0	0	0	0	0
	0	0	0	0	0	0	0	0	0	0	0	0
	0	0	0	0	0	0	0	0	0	0	0	0
Pass-By Traffic	0	0	0	0	0	0	0	0	0	0	0	0
Other Adjustments	0	0	0	0	0	0	0	0	0	0	0	0
FUTURE TRAFFIC W/ PROJECT	306	852	0	0	0	0	0	907	583	867	0	413
"New" Site Traffic % of Total 0.0%	0.0	0.9	0.0	0.0	0.0	0.0	0.0	0.6	0.7	0.7	0.0	0.0

INTERSECTION VOLUME SUMMARY
Dresher Road/Welsh Road (S.R. 0063)

Age Restricted Housing Development
 L:\eng\815367\Traffic\Analysis\SDS\SDS Opening Year 2018 Residential (Proposed P. Saturday II-2 PM
 2018

Traffic Component	EASTBOUND Welsh Road (S.R. 0063)			NORTHBOUND Dresher Road			WESTBOUND Welsh Road (S.R. 0063)			SOUTHBOUND Dresher Road		
	L	S	R	L	S	R	L	S	R	L	S	R
	EXISTING TRAFFIC	124	651	0	0	0	0	0	585	345	305	0
Seasonal Adjustment Factor 1.000	124	651	0	0	0	0	0	585	345	305	0	119
Balancing Adjustments	0	12	0	0	0	0	0	0	0	6	0	0
ADJUSTED EXISTING TRAFFIC	124	663	0	0	0	0	0	585	345	311	0	119
Background Growth 1.93 %	2	13	0	0	0	0	0	11	7	6	0	2
EXISTING W/ BACKGROUND	126	676	0	0	0	0	0	596	352	317	0	121
TOTAL "OTHER" DEVELOPMENTS	24	6	0	0	0	0	0	2	30	29	0	23
FW Triangle - Upper Dublin	0	2	0	0	0	0	0	1	1	2	0	0
Zieger Rose - Upper Dublin	2	4	0	0	0	0	0	1	0	0	0	2
Wawa Retail Site - Horsham	12	0	0	0	0	0	0	0	5	4	0	11
Single Family Homes - Horsham	1	0	0	0	0	0	0	0	3	2	0	1
Horsham Apartments	9	0	0	0	0	0	0	0	21	21	0	9
Other Adjustments	0	0	0	0	0	0	0	0	0	0	0	0
FUTURE TRAFFIC W/O PROJECT	150	682	0	0	0	0	0	598	382	346	0	144
TOTAL "NEW" SITE TRAFFIC	0	3	0	0	0	0	0	3	3	2	0	0
BT Dreshertown, LP	0	3	0	0	0	0	0	3	3	2	0	0
	0	0	0	0	0	0	0	0	0	0	0	0
	0	0	0	0	0	0	0	0	0	0	0	0
	0	0	0	0	0	0	0	0	0	0	0	0
	0	0	0	0	0	0	0	0	0	0	0	0
	0	0	0	0	0	0	0	0	0	0	0	0
	0	0	0	0	0	0	0	0	0	0	0	0
Pass-By Traffic	0	0	0	0	0	0	0	0	0	0	0	0
Other Adjustments	0	0	0	0	0	0	0	0	0	0	0	0
FUTURE TRAFFIC W/ PROJECT	150	685	0	0	0	0	0	601	385	348	0	144
"New" Site Traffic % of Total 0.0%	0.0	0.4	0.0	0.0	0.0	0.0	0.0	0.5	0.8	0.6	0.0	0.0

INTERSECTION VOLUME SUMMARY
Dreshertown Road/Welsh Road (S.R. 0063)

Age Restricted Housing Development
 I:\eng\815367\Traffic\Analysis\SDS\SDS Opening Year 2018 Residential (Proposed | Weekday 7-9 AM
 2018

Traffic Component	EASTBOUND Welsh Road (S.R. 0063)			NORTHBOUND Dreshertown Road			WESTBOUND Welsh Road (S.R. 0063)			SOUTHBOUND Dreshertown Road		
	L	S	R	L	S	R	L	S	R	L	S	R
EXISTING TRAFFIC	0	833	487	252	0	373	404	900	0	0	0	0
Seasonal Adjustment Factor 1.000	0	833	487	252	0	373	404	900	0	0	0	0
Balancing Adjustments	0	66	38	23	0	0	0	81	0	0	0	0
ADJUSTED EXISTING TRAFFIC	0	899	525	275	0	373	404	981	0	0	0	0
Background Growth 1.93 %	0	17	10	5	0	7	8	19	0	0	0	0
EXISTING W/ BACKGROUND	0	916	535	280	0	380	412	1000	0	0	0	0
TOTAL "OTHER" DEVELOPMENTS	0	38	17	9	0	4	9	9	0	0	0	0
FW Triangle - Upper Dublin	0	0	3	3	0	2	3	0	0	0	0	0
Zieger Rose - Upper Dublin	0	11	0	0	0	0	4	2	0	0	0	0
Wawa Retail Site - Horsham	0	0	3	3	0	2	2	0	0	0	0	0
Single Family Homes - Horsham	0	2	1	0	0	0	0	1	0	0	0	0
Horsham Apartments	0	25	10	3	0	0	0	6	0	0	0	0
Other Adjustments	0	0	0	0	0	0	0	0	0	0	0	0
FUTURE TRAFFIC W/O PROJECT	0	954	552	289	0	384	421	1009	0	0	0	0
TOTAL "NEW" SITE TRAFFIC	0	2	6	11	0	0	0	3	0	0	0	0
BT Dreshertown, LP	0	2	6	11	0	0	0	3	0	0	0	0
	0	0	0	0	0	0	0	0	0	0	0	0
	0	0	0	0	0	0	0	0	0	0	0	0
	0	0	0	0	0	0	0	0	0	0	0	0
	0	0	0	0	0	0	0	0	0	0	0	0
	0	0	0	0	0	0	0	0	0	0	0	0
	0	0	0	0	0	0	0	0	0	0	0	0
	0	0	0	0	0	0	0	0	0	0	0	0
Pass-By Traffic	0	0	0	0	0	0	0	0	0	0	0	0
Other Adjustments	0	0	0	0	0	0	0	0	0	0	0	0
FUTURE TRAFFIC W/ PROJECT	0	956	558	300	0	384	421	1012	0	0	0	0
"New" Site Traffic % of Total 0.0%	0.0	0.2	1.1	3.7	0.0	0.0	0.0	0.3	0.0	0.0	0.0	0.0

INTERSECTION VOLUME SUMMARY
Dreshertown Road/Welsh Road (S.R. 0063)

Age Restricted Housing Development

I:\eng\815367\Traffic\Analysis\SDS\SDS Opening Year 2018 Residential (Proposed P Weekday 4-6 PM

2018

Traffic Component	EASTBOUND Welsh Road (S.R. 0063)			NORTHBOUND Dreshertown Road			WESTBOUND Welsh Road (S.R. 0063)			SOUTHBOUND Dreshertown Road		
	L	S	R	L	S	R	L	S	R	L	S	R
	EXISTING TRAFFIC	0	1037	533	373	0	443	447	982	0	0	0
Seasonal Adjustment Factor 1.000	0	1037	533	373	0	443	447	982	0	0	0	0
Balancing Adjustments	0	46	23	15	0	0	0	38	0	0	0	0
ADJUSTED EXISTING TRAFFIC	0	1083	556	388	0	443	447	1020	0	0	0	0
Background Growth 1.93 %	0	21	11	7	0	9	9	20	0	0	0	0
EXISTING W/ BACKGROUND	0	1104	567	395	0	452	456	1040	0	0	0	0
TOTAL "OTHER" DEVELOPMENTS	0	22	12	18	0	4	12	30	0	0	0	0
FW Triangle - Upper Dublin	0	0	3	2	0	2	3	0	0	0	0	0
Zieger Rose - Upper Dublin	0	6	0	0	0	0	7	3	0	0	0	0
Wawa Retail Site - Horsham	0	0	3	3	0	2	2	0	0	0	0	0
Single Family Homes - Horsham	0	2	1	1	0	0	0	2	0	0	0	0
Horsham Apartments	0	14	5	10	0	0	0	25	0	0	0	0
Other Adjustments	0	0	0	0	0	0	0	0	0	0	0	0
FUTURE TRAFFIC W/O PROJECT	0	1126	579	411	0	456	468	1070	0	0	0	0
TOTAL "NEW" SITE TRAFFIC	0	3	11	7	0	0	0	2	0	0	0	0
BT Dreshertown, LP	0	3	11	7	0	0	0	2	0	0	0	0
	0	0	0	0	0	0	0	0	0	0	0	0
	0	0	0	0	0	0	0	0	0	0	0	0
	0	0	0	0	0	0	0	0	0	0	0	0
	0	0	0	0	0	0	0	0	0	0	0	0
	0	0	0	0	0	0	0	0	0	0	0	0
	0	0	0	0	0	0	0	0	0	0	0	0
	0	0	0	0	0	0	0	0	0	0	0	0
Pass-By Traffic	0	0	0	0	0	0	0	0	0	0	0	0
Other Adjustments	0	0	0	0	0	0	0	0	0	0	0	0
FUTURE TRAFFIC W/ PROJECT	0	1129	590	418	0	456	468	1072	0	0	0	0
"New" Site Traffic % of Total 0.0%	0.0	0.3	1.9	1.7	0.0	0.0	0.0	0.2	0.0	0.0	0.0	0.0

INTERSECTION VOLUME SUMMARY
Dreshertown Road/Welsh Road (S.R. 0063)

Age Restricted Housing Development

I:\eng\815367\Traffic\Analysis\SDS\SDS Opening Year 2018 Residential (Proposed P Saturday 11-2 PM
2018

Traffic Component	EASTBOUND Welsh Road (S.R. 0063)			NORTHBOUND Dreshertown Road			WESTBOUND Welsh Road (S.R. 0063)			SOUTHBOUND Dreshertown Road		
	L	S	R	L	S	R	L	S	R	L	S	R
	EXISTING TRAFFIC	0	817	157	151	0	291	240	761	0	0	0
Seasonal Adjustment Factor 1.000	0	817	157	151	0	291	240	761	0	0	0	0
Balancing Adjustments	0	0	0	3	0	0	0	15	0	0	0	0
ADJUSTED EXISTING TRAFFIC	0	817	157	154	0	291	240	776	0	0	0	0
Background Growth 1.93 %	0	16	3	3	0	6	5	15	0	0	0	0
EXISTING W/ BACKGROUND	0	833	160	157	0	297	245	791	0	0	0	0
TOTAL "OTHER" DEVELOPMENTS	0	21	14	15	0	5	9	18	0	0	0	0
FW Triangle - Upper Dublin	0	0	3	3	0	2	3	0	0	0	0	0
Zieger Rose - Upper Dublin	0	4	0	0	0	0	3	1	0	0	0	0
Wawa Retail Site - Horsham	0	0	4	5	0	3	3	0	0	0	0	0
Single Family Homes - Horsham	0	2	1	1	0	0	0	2	0	0	0	0
Horsham Apartments	0	15	6	6	0	0	0	15	0	0	0	0
Other Adjustments	0	0	0	0	0	0	0	0	0	0	0	0
FUTURE TRAFFIC W/O PROJECT	0	854	174	172	0	302	254	809	0	0	0	0
TOTAL "NEW" SITE TRAFFIC	0	1	4	5	0	0	0	1	0	0	0	0
BT Dreshertown, LP	0	1	4	5	0	0	0	1	0	0	0	0
	0	0	0	0	0	0	0	0	0	0	0	0
	0	0	0	0	0	0	0	0	0	0	0	0
	0	0	0	0	0	0	0	0	0	0	0	0
	0	0	0	0	0	0	0	0	0	0	0	0
	0	0	0	0	0	0	0	0	0	0	0	0
	0	0	0	0	0	0	0	0	0	0	0	0
Pass-By Traffic	0	0	0	0	0	0	0	0	0	0	0	0
Other Adjustments	0	0	0	0	0	0	0	0	0	0	0	0
FUTURE TRAFFIC W/ PROJECT	0	855	178	177	0	302	254	810	0	0	0	0
"New" Site Traffic % of Total 0.0%	0.0	0.1	2.2	2.8	0.0	0.0	0.0	0.1	0.0	0.0	0.0	0.0

INTERSECTION VOLUME SUMMARY
Dryden Road/Welsh Road (S.R. 0063)

Age Restricted Housing Development
 I:\eng\815367\Traffic\Analysis\SDS\SDS Opening Year 2018 Residential (Proposed F Weekday 7-9 AM
 2018

Traffic Component	EASTBOUND Welsh Road (S.R. 0063)			NORTHBOUND Dryden Road			WESTBOUND Welsh Road (S.R. 0063)			SOUTHBOUND Dryden Road		
	L	S	R	L	S	R	L	S	R	L	S	R
EXISTING TRAFFIC	1	1188	96	2	0	0	57	1445	1	2	0	0
Seasonal Adjustment Factor 1.000	1	1188	96	2	0	0	57	1445	1	2	0	0
Balancing Adjustments	0	0	0	0	0	0	0	0	0	0	0	0
ADJUSTED EXISTING TRAFFIC	1	1186	96	2	0	0	57	1445	1	2	0	0
Background Growth 1.93 %	0	23	0	0	0	0	0	28	0	0	0	0
EXISTING W/ BACKGROUND	1	1209	96	2	0	0	57	1473	1	2	0	0
TOTAL "OTHER" DEVELOPMENTS	0	42	0	0	0	0	0	18	0	0	0	0
FW Triangle - Upper Dublin	0	2	0	0	0	0	0	3	0	0	0	0
Zieger Rose - Upper Dublin	0	11	0	0	0	0	0	6	0	0	0	0
Wawa Retail Site - Horsham	0	2	0	0	0	0	0	2	0	0	0	0
Single Family Homes - Horsham	0	2	0	0	0	0	0	1	0	0	0	0
Horsham Apartments	0	25	0	0	0	0	0	6	0	0	0	0
Other Adjustments	0	0	0	0	0	0	0	0	0	0	0	0
FUTURE TRAFFIC W/O PROJECT	1	1251	96	2	0	0	57	1491	1	2	0	0
TOTAL "NEW" SITE TRAFFIC	0	0	2	3	0	11	6	0	0	0	0	0
BT Dreshertown, LP	0	0	2	3	0	11	6	0	0	0	0	0
	0	0	0	0	0	0	0	0	0	0	0	0
	0	0	0	0	0	0	0	0	0	0	0	0
	0	0	0	0	0	0	0	0	0	0	0	0
	0	0	0	0	0	0	0	0	0	0	0	0
	0	0	0	0	0	0	0	0	0	0	0	0
	0	0	0	0	0	0	0	0	0	0	0	0
	0	0	0	0	0	0	0	0	0	0	0	0
Pass-By Traffic	0	0	0	0	0	0	0	0	0	0	0	0
Other Adjustments	0	0	0	0	0	0	0	0	0	0	0	0
FUTURE TRAFFIC W/ PROJECT	1	1251	98	5	0	11	63	1491	1	2	0	0
"New" Site Traffic % of Total 0.0%	0.0	0.0	2.0	60.0	0.0	100.0	9.5	0.0	0.0	0.0	0.0	0.0

INTERSECTION VOLUME SUMMARY
Dryden Road/Welsh Road (S.R. 0063)

Age Restricted Housing Development
 I:\eng\815367\Traffic\Analysis\SDS\SDS Opening Year 2018 Residential (Proposed P. Weekday 4-6 PM
 2018

Traffic Component	EASTBOUND Welsh Road (S.R. 0063)			NORTHBOUND Dryden Road			WESTBOUND Welsh Road (S.R. 0063)			SOUTHBOUND Dryden Road		
	L	S	R	L	S	R	L	S	R	L	S	R
	EXISTING TRAFFIC	0	1557	5	95	8	9	0	1369	0	3	0
Seasonal Adjustment Factor 1.000	0	1557	5	95	8	9	0	1369	0	3	0	1
Balancing Adjustments	0	0	0	0	0	0	0	0	0	0	0	0
ADJUSTED EXISTING TRAFFIC	0	1557	5	95	8	9	0	1369	0	3	0	1
Background Growth 1.93 %	0	30	0	0	0	0	0	26	0	0	0	0
EXISTING W/ BACKGROUND	0	1587	5	95	8	9	0	1395	0	3	0	1
TOTAL "OTHER" DEVELOPMENTS	0	26	0	0	0	0	0	42	0	0	0	0
FW Triangle - Upper Dublin	0	2	0	0	0	0	0	3	0	0	0	0
Zieger Rose - Upper Dublin	0	6	0	0	0	0	0	10	0	0	0	0
Wawa Retail Site - Horsham	0	2	0	0	0	0	0	2	0	0	0	0
Single Family Homes - Horsham	0	2	0	0	0	0	0	2	0	0	0	0
Horsham Apartments	0	14	0	0	0	0	0	25	0	0	0	0
Other Adjustments	0	0	0	0	0	0	0	0	0	0	0	0
FUTURE TRAFFIC W/O PROJECT	0	1613	5	95	8	9	0	1437	0	3	0	1
TOTAL "NEW" SITE TRAFFIC	0	0	3	2	0	7	11	0	0	0	0	0
BT Dreshertown, LP	0	0	3	2	0	7	11	0	0	0	0	0
	0	0	0	0	0	0	0	0	0	0	0	0
	0	0	0	0	0	0	0	0	0	0	0	0
	0	0	0	0	0	0	0	0	0	0	0	0
	0	0	0	0	0	0	0	0	0	0	0	0
	0	0	0	0	0	0	0	0	0	0	0	0
	0	0	0	0	0	0	0	0	0	0	0	0
	0	0	0	0	0	0	0	0	0	0	0	0
Pass-By Traffic	0	0	0	0	0	0	0	0	0	0	0	0
Other Adjustments	0	0	0	0	0	0	0	0	0	0	0	0
FUTURE TRAFFIC W/ PROJECT	0	1613	8	97	8	16	11	1437	0	3	0	1
"New" Site Traffic % of Total 0.0%	0.0	0.0	37.5	2.1	0.0	43.8	100.0	0.0	0.0	0.0	0.0	0.0

INTERSECTION VOLUME SUMMARY
Dryden Road/Welsh Road (S.R. 0063)

Age Restricted Housing Development
 I:\eng\815367\Traffic\Analysis\SDS\SDS Opening Year 2018 Residential (Proposed P. Saturday 11-2 PM
 2018

Traffic Component	EASTBOUND Welsh Road (S.R. 0063)			NORTHBOUND Dryden Road			WESTBOUND Welsh Road (S.R. 0063)			SOUTHBOUND Dryden Road		
	L	S	R	L	S	R	L	S	R	L	S	R
	EXISTING TRAFFIC	2	1034	3	1	0	1	1	1027	2	2	0
Seasonal Adjustment Factor 1.000	2	1034	3	1	0	1	1	1027	2	2	0	2
Balancing Adjustments	0	15	0	0	0	0	0	0	0	0	0	0
ADJUSTED EXISTING TRAFFIC	2	1049	3	1	0	1	1	1027	2	2	0	2
Background Growth 1.93 %	0	20	0	0	0	0	0	20	0	0	0	0
EXISTING W/ BACKGROUND	2	1069	3	1	0	1	1	1047	2	2	0	2
TOTAL "OTHER" DEVELOPMENTS	0	26	0	0	0	0	0	27	0	0	0	0
FW Triangle - Upper Dublin	0	2	0	0	0	0	0	3	0	0	0	0
Zieger Rose - Upper Dublin	0	4	0	0	0	0	0	4	0	0	0	0
Wawa Retail Site - Horsham	0	3	0	0	0	0	0	3	0	0	0	0
Single Family Homes - Horsham	0	2	0	0	0	0	0	2	0	0	0	0
Horsham Apartments	0	15	0	0	0	0	0	15	0	0	0	0
Other Adjustments	0	0	0	0	0	0	0	0	0	0	0	0
FUTURE TRAFFIC W/O PROJECT	2	1095	3	1	0	1	1	1074	2	2	0	2
TOTAL "NEW" SITE TRAFFIC	0	0	1	1	0	5	5	0	0	0	0	0
BT Dreshertown, LP	0	0	1	1	0	5	5	0	0	0	0	0
	0	0	0	0	0	0	0	0	0	0	0	0
	0	0	0	0	0	0	0	0	0	0	0	0
	0	0	0	0	0	0	0	0	0	0	0	0
	0	0	0	0	0	0	0	0	0	0	0	0
	0	0	0	0	0	0	0	0	0	0	0	0
	0	0	0	0	0	0	0	0	0	0	0	0
	0	0	0	0	0	0	0	0	0	0	0	0
Pass-By Traffic	0	0	0	0	0	0	0	0	0	0	0	0
Other Adjustments	0	0	0	0	0	0	0	0	0	0	0	0
FUTURE TRAFFIC W/ PROJECT	2	1095	4	2	0	6	6	1074	2	2	0	2
"New" Site Traffic % of Total 0.0%	0.0	0.0	25.0	50.0	0.0	83.3	83.3	0.0	0.0	0.0	0.0	0.0

INTERSECTION VOLUME SUMMARY
Dreshertown Road/Dryden Road Extension

Age Restricted Housing Development
 I:\eng\815367\Traffic\Analysis\SDS\SDS Opening Year 2018 Residential (Proposed **Weekday 7-9 AM**
 2018

Traffic Component	EASTBOUND Dryden Road Extension			NORTHBOUND Dreshertown Road			WESTBOUND Dryden Road Extension			SOUTHBOUND Dreshertown Road		
	L	S	R	L	S	R	L	S	R	L	S	R
EXISTING TRAFFIC	0	0	0	0	625	0	0	0	0	0	891	0
Seasonal Adjustment Factor 1.000	0	0	0	0	625	0	0	0	0	0	891	0
Balancing Adjustments	0	0	0	0	23	0	0	0	0	0	38	0
ADJUSTED EXISTING TRAFFIC	0	0	0	0	648	0	0	0	0	0	929	0
Background Growth 1.93 %	0	0	0	0	13	0	0	0	0	0	18	0
EXISTING W/ BACKGROUND	0	0	0	0	661	0	0	0	0	0	947	0
TOTAL "OTHER" DEVELOPMENTS	0	0	0	0	14	0	0	0	0	0	26	0
FW Triangle - Upper Dublin	0	0	0	0	5	0	0	0	0	0	6	0
Zieger Rose - Upper Dublin	0	0	0	0	0	0	0	0	0	0	4	0
Wawa Retail Site - Horsham	0	0	0	0	6	0	0	0	0	0	5	0
Single Family Homes - Horsham	0	0	0	0	0	0	0	0	0	0	1	0
Horsham Apartments	0	0	0	0	3	0	0	0	0	0	10	0
Other Adjustments	0	0	0	0	0	0	0	0	0	0	0	0
FUTURE TRAFFIC W/O PROJECT	0	0	0	0	675	0	0	0	0	0	973	0
TOTAL "NEW" SITE TRAFFIC	0	0	0	0	0	4	7	0	11	6	0	0
BT Dreshertown, LP	0	0	0	0	0	4	7	0	11	6	0	0
	0	0	0	0	0	0	0	0	0	0	0	0
	0	0	0	0	0	0	0	0	0	0	0	0
	0	0	0	0	0	0	0	0	0	0	0	0
	0	0	0	0	0	0	0	0	0	0	0	0
	0	0	0	0	0	0	0	0	0	0	0	0
	0	0	0	0	0	0	0	0	0	0	0	0
Pass-By Traffic	0	0	0	0	0	0	0	0	0	0	0	0
Other Adjustments	0	0	0	0	0	0	0	0	0	0	0	0
FUTURE TRAFFIC W/ PROJECT	0	0	0	0	675	4	7	0	11	6	973	0
"New" Site Traffic % of Total 0.0%	0.0	0.0	0.0	0.0	0.0	100.0	100.0	0.0	100.0	100.0	0.0	0.0

INTERSECTION VOLUME SUMMARY
Dreshertown Road/Dryden Road Extension

Age Restricted Housing Development
 I:\eng\815367\Traffic\Analysis\SDS\SDS Opening Year 2018 Residential (Proposed P Weekday 4-6 PM
 2018

Traffic Component	EASTBOUND Dryden Road Extension			NORTHBOUND Dreshertown Road			WESTBOUND Dryden Road Extension			SOUTHBOUND Dreshertown Road		
	L	S	R	L	S	R	L	S	R	L	S	R
	EXISTING TRAFFIC	0	0	0	0	816	0	0	0	0	0	980
Seasonal Adjustment Factor 1.000	0	0	0	0	816	0	0	0	0	0	980	0
Balancing Adjustments	0	0	0	0	15	0	0	0	0	0	23	0
ADJUSTED EXISTING TRAFFIC	0	0	0	0	831	0	0	0	0	0	1003	0
Background Growth 1.93 %	0	0	0	0	16	0	0	0	0	0	19	0
EXISTING W/ BACKGROUND	0	0	0	0	847	0	0	0	0	0	1022	0
TOTAL "OTHER" DEVELOPMENTS	0	0	0	0	20	0	0	0	0	0	24	0
FW Triangle - Upper Dublin	0	0	0	0	3	0	0	0	0	0	6	0
Zieger Rose - Upper Dublin	0	0	0	0	0	0	0	0	0	0	7	0
Wawa Retail Site - Horsham	0	0	0	0	6	0	0	0	0	0	5	0
Single Family Homes - Horsham	0	0	0	0	1	0	0	0	0	0	1	0
Horsham Apartments	0	0	0	0	10	0	0	0	0	0	5	0
Other Adjustments	0	0	0	0	0	0	0	0	0	0	0	0
FUTURE TRAFFIC W/O PROJECT	0	0	0	0	867	0	0	0	0	0	1046	0
TOTAL "NEW" SITE TRAFFIC	0	0	0	0	0	6	3	0	7	11	0	0
BT Dreshertown, LP	0	0	0	0	0	6	3	0	7	11	0	0
	0	0	0	0	0	0	0	0	0	0	0	0
	0	0	0	0	0	0	0	0	0	0	0	0
	0	0	0	0	0	0	0	0	0	0	0	0
	0	0	0	0	0	0	0	0	0	0	0	0
	0	0	0	0	0	0	0	0	0	0	0	0
	0	0	0	0	0	0	0	0	0	0	0	0
	0	0	0	0	0	0	0	0	0	0	0	0
Pass-By Traffic	0	0	0	0	0	0	0	0	0	0	0	0
Other Adjustments	0	0	0	0	0	0	0	0	0	0	0	0
FUTURE TRAFFIC W/ PROJECT	0	0	0	0	867	6	3	0	7	11	1046	0
"New" Site Traffic % of Total 0.0%	0.0	0.0	0.0	0.0	0.0	100.0	100.0	0.0	100.0	100.0	0.0	0.0

INTERSECTION VOLUME SUMMARY Dreshertown Road/Dryden Road Extension

Age Restricted Housing Development
 I:\eng\815367\Traffic\Analysis\SDS\SDS Opening Year 2018 Residential (Proposed P Saturday 11-2 PM
 2018

Traffic Component	EASTBOUND Dryden Road Extension			NORTHBOUND Dreshertown Road			WESTBOUND Dryden Road Extension			SOUTHBOUND Dreshertown Road		
	L	S	R	L	S	R	L	S	R	L	S	R
	EXISTING TRAFFIC	0	0	0	0	442	0	0	0	0	0	397
Seasonal Adjustment Factor 1.000	0	0	0	0	442	0	0	0	0	0	397	0
Balancing Adjustments	0	0	0	0	3	0	0	0	0	0	0	0
ADJUSTED EXISTING TRAFFIC	0	0	0	0	445	0	0	0	0	0	397	0
Background Growth 1.93 %	0	0	0	0	9	0	0	0	0	0	8	0
EXISTING W/ BACKGROUND	0	0	0	0	454	0	0	0	0	0	405	0
TOTAL "OTHER" DEVELOPMENTS	0	0	0	0	20	0	0	0	0	0	23	0
FW Triangle - Upper Dublin	0	0	0	0	5	0	0	0	0	0	6	0
Zieger Rose - Upper Dublin	0	0	0	0	0	0	0	0	0	0	3	0
Wawa Retail Site - Horsham	0	0	0	0	8	0	0	0	0	0	7	0
Single Family Homes - Horsham	0	0	0	0	1	0	0	0	0	0	1	0
Horsham Apartments	0	0	0	0	6	0	0	0	0	0	6	0
Other Adjustments	0	0	0	0	0	0	0	0	0	0	0	0
FUTURE TRAFFIC W/O PROJECT	0	0	0	0	474	0	0	0	0	0	428	0
TOTAL "NEW" SITE TRAFFIC	0	0	0	0	0	2	3	0	5	4	0	0
BT Dreshertown, LP	0	0	0	0	0	2	3	0	5	4	0	0
	0	0	0	0	0	0	0	0	0	0	0	0
	0	0	0	0	0	0	0	0	0	0	0	0
	0	0	0	0	0	0	0	0	0	0	0	0
	0	0	0	0	0	0	0	0	0	0	0	0
	0	0	0	0	0	0	0	0	0	0	0	0
	0	0	0	0	0	0	0	0	0	0	0	0
	0	0	0	0	0	0	0	0	0	0	0	0
Pass-By Traffic	0	0	0	0	0	0	0	0	0	0	0	0
Other Adjustments	0	0	0	0	0	0	0	0	0	0	0	0
FUTURE TRAFFIC W/ PROJECT	0	0	0	0	474	2	3	0	5	4	428	0
"New" Site Traffic % of Total 0.0%	0.0	0.0	0.0	0.0	0.0	100.0	100.0	0.0	100.0	100.0	0.0	0.0

INTERSECTION VOLUME SUMMARY
Jarrettown Road/Welsh Road (S.R. 0063)

Age Restricted Housing Development
 I:\eng\815367\Traffic\Analysis\SDS\SDS Opening Year 2018 Residential (Proposed F Weekday 7-9 AM
 2018

Traffic Component	EASTBOUND Welsh Road (S.R. 0063)			NORTHBOUND Jarrettown Road			WESTBOUND Welsh Road (S.R. 0063)			SOUTHBOUND Jarrettown Road		
	L	S	R	L	S	R	L	S	R	L	S	R
EXISTING TRAFFIC	55	843	14	10	58	309	261	624	8	9	19	27
Seasonal Adjustment Factor 1.000	55	843	14	10	58	309	261	624	8	9	19	27
Balancing Adjustments	0	0	0	0	0	0	7	18	0	0	0	0
ADJUSTED EXISTING TRAFFIC	55	843	14	10	58	309	268	642	8	9	19	27
Background Growth 1.93 %	1	16	0	0	1	6	5	12	0	0	0	1
EXISTING W/ BACKGROUND	56	859	14	10	59	315	273	654	8	9	19	28
TOTAL "OTHER" DEVELOPMENTS	0	11	4	8	0	20	12	18	0	0	0	0
FW Triangle - Upper Dublin	0	1	0	0	0	0	0	1	0	0	0	0
Zieger Rose - Upper Dublin	0	0	4	8	0	17	5	0	0	0	0	0
Wawa Retail Site - Horsham	0	7	0	0	0	2	2	6	0	0	0	0
Single Family Homes - Horsham	0	0	0	0	0	0	0	1	0	0	0	0
Horsham Apartments	0	3	0	0	0	1	5	10	0	0	0	0
Other Adjustments	0	0	0	0	0	0	0	0	0	0	0	0
FUTURE TRAFFIC W/O PROJECT	56	870	18	18	59	335	285	672	8	9	19	28
TOTAL "NEW" SITE TRAFFIC	0	3	0	0	0	1	2	6	0	0	0	0
BT Dreshertown, LP	0	3	0	0	0	1	2	6	0	0	0	0
	0	0	0	0	0	0	0	0	0	0	0	0
	0	0	0	0	0	0	0	0	0	0	0	0
	0	0	0	0	0	0	0	0	0	0	0	0
	0	0	0	0	0	0	0	0	0	0	0	0
	0	0	0	0	0	0	0	0	0	0	0	0
	0	0	0	0	0	0	0	0	0	0	0	0
Pass-By Traffic	0	0	0	0	0	0	0	0	0	0	0	0
Other Adjustments	0	0	0	0	0	0	0	0	0	0	0	0
FUTURE TRAFFIC W/ PROJECT	56	873	18	18	59	336	287	678	8	9	19	28
"New" Site Traffic % of Total 0.0%	0.0	0.3	0.0	0.0	0.0	0.3	0.7	0.9	0.0	0.0	0.0	0.0

INTERSECTION VOLUME SUMMARY
Jarrettown Road/Welsh Road (S.R. 0063)

Age Restricted Housing Development
 I:\eng\815367\Traffic\Analysis\SDS\SDS Opening Year 2018 Residential (Proposed P. Weekday 4-6 PM
 2018

Traffic Component	EASTBOUND Welsh Road (S.R. 0063)			NORTHBOUND Jarrettown Road			WESTBOUND Welsh Road (S.R. 0063)			SOUTHBOUND Jarrettown Road		
	L	S	R	L	S	R	L	S	R	L	S	R
EXISTING TRAFFIC	21	661	22	16	20	208	230	905	14	40	89	103
Seasonal Adjustment Factor 1.000	21	661	22	16	20	208	230	905	14	40	89	103
Balancing Adjustments	0	97	0	0	0	31	12	41	0	0	0	0
ADJUSTED EXISTING TRAFFIC	21	758	22	16	20	239	242	946	14	40	89	103
Background Growth 1.93 %	0	15	0	0	0	5	5	18	0	1	2	2
EXISTING W/ BACKGROUND	21	773	22	16	20	244	247	964	14	41	91	105
TOTAL "OTHER" DEVELOPMENTS	0	20	7	5	0	17	14	12	0	0	0	0
FW Triangle - Upper Dublin	0	2	0	0	0	0	0	1	0	0	0	0
Zieger Rose - Upper Dublin	0	0	7	5	0	10	9	0	0	0	0	0
Wawa Retail Site - Horsham	0	7	0	0	0	2	2	5	0	0	0	0
Single Family Homes - Horsham	0	1	0	0	0	0	0	1	0	0	0	0
Horsham Apartments	0	10	0	0	0	5	3	5	0	0	0	0
Other Adjustments	0	0	0	0	0	0	0	0	0	0	0	0
FUTURE TRAFFIC W/O PROJECT	21	793	29	21	20	261	261	976	14	41	91	105
TOTAL "NEW" SITE TRAFFIC	0	6	0	0	0	2	1	4	0	0	0	0
BT Dreshertown, LP	0	6	0	0	0	2	1	4	0	0	0	0
	0	0	0	0	0	0	0	0	0	0	0	0
	0	0	0	0	0	0	0	0	0	0	0	0
	0	0	0	0	0	0	0	0	0	0	0	0
	0	0	0	0	0	0	0	0	0	0	0	0
	0	0	0	0	0	0	0	0	0	0	0	0
	0	0	0	0	0	0	0	0	0	0	0	0
Pass-By Traffic	0	0	0	0	0	0	0	0	0	0	0	0
Other Adjustments	0	0	0	0	0	0	0	0	0	0	0	0
FUTURE TRAFFIC W/ PROJECT	21	799	29	21	20	263	262	980	14	41	91	105
"New" Site Traffic % of Total 0.0%	0.0	0.8	0.0	0.0	0.0	0.8	0.4	0.4	0.0	0.0	0.0	0.0

INTERSECTION VOLUME SUMMARY
Jarrettown Road/Welsh Road (S.R. 0063)

Age Restricted Housing Development
 I:\eng\815367\Traffic\Analysis\SDS\SDS Opening Year 2018 Residential (Proposed P. Saturday 11-2 PM
 2018

Traffic Component	EASTBOUND Welsh Road (S.R. 0063)			NORTHBOUND Jarrettown Road			WESTBOUND Welsh Road (S.R. 0063)			SOUTHBOUND Jarrettown Road		
	L	S	R	L	S	R	L	S	R	L	S	R
EXISTING TRAFFIC	10	574	16	4	2	169	122	533	8	12	2	7
Seasonal Adjustment Factor 1.000	10	574	16	4	2	169	122	533	8	12	2	7
Balancing Adjustments	0	0	0	0	0	0	1	4	0	0	0	0
ADJUSTED EXISTING TRAFFIC	10	574	16	4	2	169	123	537	8	12	2	7
Background Growth 1.93 %	0	11	0	0	0	3	2	10	0	0	0	0
EXISTING W/ BACKGROUND	10	585	16	4	2	172	125	547	8	12	2	7
TOTAL "OTHER" DEVELOPMENTS	0	18	3	3	0	13	9	16	0	0	0	0
FW Triangle - Upper Dublin	0	2	0	0	0	0	0	1	0	0	0	0
Zieger Rose - Upper Dublin	0	0	3	3	0	7	3	0	0	0	0	0
Wawa Retail Site - Horsham	0	9	0	0	0	3	3	8	0	0	0	0
Single Family Homes - Horsham	0	1	0	0	0	0	0	1	0	0	0	0
Horsham Apartments	0	6	0	0	0	3	3	6	0	0	0	0
Other Adjustments	0	0	0	0	0	0	0	0	0	0	0	0
FUTURE TRAFFIC W/O PROJECT	10	603	19	7	2	185	134	563	8	12	2	7
TOTAL "NEW" SITE TRAFFIC	0	2	0	0	0	1	1	2	0	0	0	0
BT Dreshertown, LP	0	2	0	0	0	1	1	2	0	0	0	0
	0	0	0	0	0	0	0	0	0	0	0	0
	0	0	0	0	0	0	0	0	0	0	0	0
	0	0	0	0	0	0	0	0	0	0	0	0
	0	0	0	0	0	0	0	0	0	0	0	0
	0	0	0	0	0	0	0	0	0	0	0	0
	0	0	0	0	0	0	0	0	0	0	0	0
Pass-By Traffic	0	0	0	0	0	0	0	0	0	0	0	0
Other Adjustments	0	0	0	0	0	0	0	0	0	0	0	0
FUTURE TRAFFIC W/ PROJECT	10	605	19	7	2	186	135	565	8	12	2	7
"New" Site Traffic % of Total 0.0%	0.0	0.3	0.0	0.0	0.0	0.5	0.7	0.4	0.0	0.0	0.0	0.0

INTERSECTION VOLUME SUMMARY
Dresher Road/Welsh Road (S.R. 0063)

Age Restricted Housing Development
 I:\eng\815367\Traffic\Analysis\SDS\SDS Design Year 2023 Residential and C Weekday 7-9 AM
 2023

Traffic Component	EASTBOUND Welsh Road (S.R. 0063)			NORTHBOUND Dresher Road			WESTBOUND Welsh Road (S.R. 0063)			SOUTHBOUND Dresher Road		
	L	S	R	L	S	R	L	S	R	L	S	R
EXISTING TRAFFIC	387	803	0	0	0	0	0	688	568	621	0	278
Seasonal Adjustment Factor ####	387	803	0	0	0	0	0	688	568	621	0	278
Balancing Adjustments	0	0	0	0	0	0	0	0	0	0	0	0
ADJUSTED EXISTING TRAFFIC	387	803	0	0	0	0	0	688	568	621	0	278
Background Growth 5.24 %	20	42	0	0	0	0	0	36	30	33	0	15
EXISTING W/ BACKGROUND	407	845	0	0	0	0	0	724	598	654	0	293
TOTAL "OTHER" DEVELOPMENTS	19	12	0	0	0	0	0	3	14	42	0	27
FW Triangle - Upper Dublin	0	1	0	0	0	0	0	1	1	1	0	0
Zieger Rose - Upper Dublin	6	11	0	0	0	0	0	2	0	0	0	3
Wawa Retail Site - Horsham	9	0	0	0	0	0	0	0	3	3	0	8
Single Family Homes - Horsham	0	0	0	0	0	0	0	0	1	3	0	1
Horsham Apartments	4	0	0	0	0	0	0	0	9	35	0	15
Other Adjustments	0	0	0	0	0	0	0	0	0	0	0	0
FUTURE TRAFFIC W/O PROJECT	426	857	0	0	0	0	0	727	612	696	0	320
TOTAL "NEW" SITE TRAFFIC	0	46	0	0	0	0	0	69	56	36	0	0
Prudential Site	0	46	0	0	0	0	0	69	56	36	0	0
	0	0	0	0	0	0	0	0	0	0	0	0
	0	0	0	0	0	0	0	0	0	0	0	0
	0	0	0	0	0	0	0	0	0	0	0	0
	0	0	0	0	0	0	0	0	0	0	0	0
	0	0	0	0	0	0	0	0	0	0	0	0
	0	0	0	0	0	0	0	0	0	0	0	0
Pass-By Traffic	0	0	0	0	0	0	0	1	1	0	0	0
Dryden Road Extension Diversions	0	0	0	0	0	0	0	0	0	0	0	0
FUTURE TRAFFIC W/ PROJECT	426	903	0	0	0	0	0	797	669	732	0	320
"New" Site Traffic % of Total ####	0.0	5.1	0.0	0.0	0.0	0.0	0.0	8.7	8.4	4.9	0.0	0.0

INTERSECTION VOLUME SUMMARY
Dresher Road/Welsh Road (S.R. 0063)

Age Restricted Housing Development
 I:\eng\815367\Traffic\Analysis\SDS\SDS Design Year 2023 Residential and C Weekday 4-6 PM
 2023

Traffic Component	EASTBOUND Welsh Road (S.R. 0063)			NORTHBOUND Dresher Road			WESTBOUND Welsh Road (S.R. 0063)			SOUTHBOUND Dresher Road		
	L	S	R	L	S	R	L	S	R	L	S	R
	EXISTING TRAFFIC	272	820	0	0	0	0	0	881	527	819	0
Seasonal Adjustment Factor 1.000	272	820	0	0	0	0	0	881	527	819	0	384
Balancing Adjustments	0	0	0	0	0	0	0	0	0	0	0	0
ADJUSTED EXISTING TRAFFIC	272	820	0	0	0	0	0	881	527	819	0	384
Background Growth 5.24 %	14	43	0	0	0	0	0	46	28	43	0	20
EXISTING W/ BACKGROUND	286	863	0	0	0	0	0	927	555	862	0	404
TOTAL "OTHER" DEVELOPMENTS	29	8	0	0	0	0	0	4	42	26	0	22
FW Triangle - Upper Dublin	0	2	0	0	0	0	0	1	1	2	0	0
Zieger Rose - Upper Dublin	4	6	0	0	0	0	0	3	0	0	0	6
Wawa Retail Site - Horsham	9	0	0	0	0	0	0	0	3	3	0	7
Single Family Homes - Horsham	1	0	0	0	0	0	0	0	3	2	0	1
Horsham Apartments	15	0	0	0	0	0	0	0	35	19	0	8
Other Adjustments	0	0	0	0	0	0	0	0	0	0	0	0
FUTURE TRAFFIC W/O PROJECT	315	871	0	0	0	0	0	931	597	888	0	426
TOTAL "NEW" SITE TRAFFIC	0	97	0	0	0	0	0	78	63	77	0	0
Prudential Site	0	97	0	0	0	0	0	78	63	77	0	0
	0	0	0	0	0	0	0	0	0	0	0	0
	0	0	0	0	0	0	0	0	0	0	0	0
	0	0	0	0	0	0	0	0	0	0	0	0
	0	0	0	0	0	0	0	0	0	0	0	0
	0	0	0	0	0	0	0	0	0	0	0	0
	0	0	0	0	0	0	0	0	0	0	0	0
	0	0	0	0	0	0	0	0	0	0	0	0
Pass-By Traffic	0	0	0	0	0	0	0	-1	0	0	0	0
Dryden Road Extension Diversions	0	0	0	0	0	0	0	0	0	0	0	0
FUTURE TRAFFIC W/ PROJECT	315	968	0	0	0	0	0	1008	660	965	0	426
"New" Site Traffic % of Total ####	0.0	10.0	0.0	0.0	0.0	0.0	0.0	7.7	9.5	8.0	0.0	0.0

INTERSECTION VOLUME SUMMARY
Dresher Road/Welsh Road (S.R. 0063)

Age Restricted Housing Development
 I:\eng\815367\TrafficAnalysis\SDS\SDS Design Year 2023 Residential and Cc Saturday 11-2 PM
 2023

Traffic Component	EASTBOUND Welsh Road (S.R. 0063)			NORTHBOUND Dresher Road			WESTBOUND Welsh Road (S.R. 0063)			SOUTHBOUND Dresher Road		
	L	S	R	L	S	R	L	S	R	L	S	R
	EXISTING TRAFFIC	124	651	0	0	0	0	0	585	345	305	0
Seasonal Adjustment Factor 1.000	124	651	0	0	0	0	0	585	345	305	0	119
Balancing Adjustments	0	12	0	0	0	0	0	0	0	6	0	0
ADJUSTED EXISTING TRAFFIC	124	663	0	0	0	0	0	585	345	311	0	119
Background Growth 5.24 %	6	35	0	0	0	0	0	31	18	16	0	6
EXISTING W/ BACKGROUND	130	698	0	0	0	0	0	616	363	327	0	125
TOTAL "OTHER" DEVELOPMENTS	24	6	0	0	0	0	0	2	30	29	0	23
FW Triangle - Upper Dublin	0	2	0	0	0	0	0	1	1	2	0	0
Zieger Rose - Upper Dublin	2	4	0	0	0	0	0	1	0	0	0	2
Wawa Retail Site - Horsham	12	0	0	0	0	0	0	0	5	4	0	11
Single Family Homes - Horsham	1	0	0	0	0	0	0	0	3	2	0	1
Horsham Apartments	9	0	0	0	0	0	0	0	21	21	0	9
Other Adjustments	0	0	0	0	0	0	0	0	0	0	0	0
FUTURE TRAFFIC W/O PROJECT	154	704	0	0	0	0	0	618	393	356	0	148
TOTAL "NEW" SITE TRAFFIC	0	146	0	0	0	0	0	137	109	117	0	0
Prudential Site	0	146	0	0	0	0	0	137	109	117	0	0
	0	0	0	0	0	0	0	0	0	0	0	0
	0	0	0	0	0	0	0	0	0	0	0	0
	0	0	0	0	0	0	0	0	0	0	0	0
	0	0	0	0	0	0	0	0	0	0	0	0
	0	0	0	0	0	0	0	0	0	0	0	0
	0	0	0	0	0	0	0	0	0	0	0	0
	0	0	0	0	0	0	0	0	0	0	0	0
Pass-By Traffic	0	0	0	0	0	0	0	-4	-2	0	0	0
Dryden Road Extension Diversions	0	0	0	0	0	0	0	0	0	0	0	0
FUTURE TRAFFIC W/ PROJECT	154	850	0	0	0	0	0	751	500	473	0	148
"New" Site Traffic % of Total ####	0.0	17.2	0.0	0.0	0.0	0.0	0.0	18.2	21.8	24.7	0.0	0.0

INTERSECTION VOLUME SUMMARY Dreshertown Road/Welsh Road (S.R. 0063)

Age Restricted Housing Development
I:\eng\815367\Traffic\Analysis\SDS\SDS Design Year 2023 Residential and C Weekday 7-9 AM
2023

Traffic Component	EASTBOUND Welsh Road (S.R. 0063)			NORTHBOUND Dreshertown Road			WESTBOUND Welsh Road (S.R. 0063)			SOUTHBOUND Dreshertown Road		
	L	S	R	L	S	R	L	S	R	L	S	R
EXISTING TRAFFIC	0	833	487	252	0	373	404	900	0	0	0	0
Seasonal Adjustment Factor ####	0	833	487	252	0	373	404	900	0	0	0	0
Balancing Adjustments	0	66	38	23	0	0	0	81	0	0	0	0
ADJUSTED EXISTING TRAFFIC	0	899	525	275	0	373	404	981	0	0	0	0
Background Growth 5.24 %	0	47	27	14	0	20	21	51	0	0	0	0
EXISTING W/ BACKGROUND	0	946	552	289	0	393	425	1032	0	0	0	0
TOTAL "OTHER" DEVELOPMENTS	0	38	17	9	0	4	9	9	0	0	0	0
FW Triangle - Upper Dublin	0	0	3	3	0	2	3	0	0	0	0	0
Zieger Rose - Upper Dublin	0	11	0	0	0	0	4	2	0	0	0	0
Wawa Retail Site - Horsham	0	0	3	3	0	2	2	0	0	0	0	0
Single Family Homes - Horsham	0	2	1	0	0	0	0	1	0	0	0	0
Horsham Apartments	0	25	10	3	0	0	0	6	0	0	0	0
Other Adjustments	0	0	0	0	0	0	0	0	0	0	0	0
FUTURE TRAFFIC W/O PROJECT	0	984	569	298	0	397	434	1041	0	0	0	0
TOTAL "NEW" SITE TRAFFIC	0	55	27	42	0	0	0	83	0	0	0	0
Prudential Site	0	55	27	42	0	0	0	83	0	0	0	0
	0	0	0	0	0	0	0	0	0	0	0	0
	0	0	0	0	0	0	0	0	0	0	0	0
	0	0	0	0	0	0	0	0	0	0	0	0
	0	0	0	0	0	0	0	0	0	0	0	0
	0	0	0	0	0	0	0	0	0	0	0	0
	0	0	0	0	0	0	0	0	0	0	0	0
	0	0	0	0	0	0	0	0	0	0	0	0
Pass-By Traffic	0	0	0	1	0	0	0	1	0	0	0	0
Dryden Road Extension Diversions	0	-25	25	0	0	-70	-64	0	0	0	0	0
FUTURE TRAFFIC W/ PROJECT	0	1014	621	341	0	327	370	1125	0	0	0	0
"New" Site Traffic % of Total ####	0.0	5.4	4.3	12.3	0.0	0.0	0.0	7.4	0.0	0.0	0.0	0.0

INTERSECTION VOLUME SUMMARY Dreshertown Road/Welsh Road (S.R. 0063)

Age Restricted Housing Development
 I:\eng\815367\Traffic\Analysis\SDS\SDS Design Year 2023 Residential and Cc Weekday 4-6 PM
 2023

Traffic Component	EASTBOUND Welsh Road (S.R. 0063)			NORTHBOUND Dreshertown Road			WESTBOUND Welsh Road (S.R. 0063)			SOUTHBOUND Dreshertown Road		
	L	S	R	L	S	R	L	S	R	L	S	R
EXISTING TRAFFIC	0	1037	533	373	0	443	447	982	0	0	0	0
Seasonal Adjustment Factor 1.000	0	1037	533	373	0	443	447	982	0	0	0	0
Balancing Adjustments	0	46	23	15	0	0	0	38	0	0	0	0
ADJUSTED EXISTING TRAFFIC	0	1083	556	388	0	443	447	1020	0	0	0	0
Background Growth 5.24 %	0	57	29	20	0	23	23	53	0	0	0	0
EXISTING W/ BACKGROUND	0	1140	585	408	0	466	470	1073	0	0	0	0
TOTAL "OTHER" DEVELOPMENTS	0	22	12	16	0	4	12	30	0	0	0	0
FW Triangle - Upper Dublin	0	0	3	2	0	2	3	0	0	0	0	0
Zieger Rose - Upper Dublin	0	6	0	0	0	0	7	3	0	0	0	0
Wawa Retail Site - Horsham	0	0	3	3	0	2	2	0	0	0	0	0
Single Family Homes - Horsham	0	2	1	1	0	0	0	2	0	0	0	0
Horsham Apartments	0	14	5	10	0	0	0	25	0	0	0	0
Other Adjustments	0	0	0	0	0	0	0	0	0	0	0	0
FUTURE TRAFFIC W/O PROJECT	0	1162	597	424	0	470	482	1103	0	0	0	0
TOTAL "NEW" SITE TRAFFIC	0	116	58	47	0	0	0	94	0	0	0	0
Prudential Site	0	116	58	47	0	0	0	94	0	0	0	0
	0	0	0	0	0	0	0	0	0	0	0	0
	0	0	0	0	0	0	0	0	0	0	0	0
	0	0	0	0	0	0	0	0	0	0	0	0
	0	0	0	0	0	0	0	0	0	0	0	0
	0	0	0	0	0	0	0	0	0	0	0	0
	0	0	0	0	0	0	0	0	0	0	0	0
	0	0	0	0	0	0	0	0	0	0	0	0
Pass-By Traffic	0	0	0	0	0	0	0	-1	0	0	0	0
Dryden Road Extension Diversions	0	-1	1	24	0	-70	-81	-24	0	0	0	0
FUTURE TRAFFIC W/ PROJECT	0	1277	656	495	0	400	401	1172	0	0	0	0
"New" Site Traffic % of Total ###	0.0	9.1	8.8	9.5	0.0	0.0	0.0	8.0	0.0	0.0	0.0	0.0

INTERSECTION VOLUME SUMMARY Dreshertown Road/Welsh Road (S.R. 0063)

Age Restricted Housing Development
I:\eng\815367\Traffic\Analysis\SDS\SDS Design Year 2023 Residential and Co Saturday 11-2 PM
2023

Traffic Component	EASTBOUND Welsh Road (S.R. 0063)			NORTHBOUND Dreshertown Road			WESTBOUND Welsh Road (S.R. 0063)			SOUTHBOUND Dreshertown Road		
	L	S	R	L	S	R	L	S	R	L	S	R
	EXISTING TRAFFIC	0	817	157	151	0	291	240	761	0	0	0
Seasonal Adjustment Factor 1.000	0	817	157	151	0	291	240	761	0	0	0	0
Balancing Adjustments	0	0	0	3	0	0	0	15	0	0	0	0
ADJUSTED EXISTING TRAFFIC	0	817	157	154	0	291	240	776	0	0	0	0
Background Growth 5.24 %	0	43	8	8	0	15	13	41	0	0	0	0
EXISTING W/ BACKGROUND	0	860	165	162	0	306	253	817	0	0	0	0
TOTAL "OTHER" DEVELOPMENTS	0	21	14	15	0	5	9	18	0	0	0	0
FW Triangle - Upper Dublin	0	0	3	3	0	2	3	0	0	0	0	0
Zieger Rose - Upper Dublin	0	4	0	0	0	0	3	1	0	0	0	0
Wawa Retail Site - Horsham	0	0	4	5	0	3	3	0	0	0	0	0
Single Family Homes - Horsham	0	2	1	1	0	0	0	2	0	0	0	0
Horsham Apartments	0	15	6	6	0	0	0	15	0	0	0	0
Other Adjustments	0	0	0	0	0	0	0	0	0	0	0	0
FUTURE TRAFFIC W/O PROJECT	0	881	179	177	0	311	262	835	0	0	0	0
TOTAL "NEW" SITE TRAFFIC	0	175	88	82	0	0	0	164	0	0	0	0
Prudential Site	0	175	88	82	0	0	0	164	0	0	0	0
	0	0	0	0	0	0	0	0	0	0	0	0
	0	0	0	0	0	0	0	0	0	0	0	0
	0	0	0	0	0	0	0	0	0	0	0	0
	0	0	0	0	0	0	0	0	0	0	0	0
	0	0	0	0	0	0	0	0	0	0	0	0
	0	0	0	0	0	0	0	0	0	0	0	0
	0	0	0	0	0	0	0	0	0	0	0	0
Pass-By Traffic	0	0	0	-1	0	-1	-1	-5	0	0	0	0
Dryden Road Extension Diversions	0	-1	1	0	0	-47	-39	0	0	0	0	0
FUTURE TRAFFIC W/ PROJECT	0	1055	268	258	0	263	222	994	0	0	0	0
"New" Site Traffic % of Total ####	0.0	16.6	32.8	31.8	0.0	0.0	0.0	16.5	0.0	0.0	0.0	0.0

INTERSECTION VOLUME SUMMARY Dryden Road/Welsh Road (S.R. 0063)

Age Restricted Housing Development
 I:\eng\815367\TrafficAnalysis\SDS\SDS Design Year 2023 Residential and C Weekday 7-9 AM
 2023

Traffic Component	EASTBOUND Welsh Road (S.R. 0063)			NORTHBOUND Dryden Road			WESTBOUND Welsh Road (S.R. 0063)			SOUTHBOUND Dryden Road		
	L	S	R	L	S	R	L	S	R	L	S	R
EXISTING TRAFFIC	1	1186	96	2	0	0	57	1445	1	2	0	0
Seasonal Adjustment Factor ####	1	1186	96	2	0	0	57	1445	1	2	0	0
Balancing Adjustments	0	0	0	0	0	0	0	0	0	0	0	0
ADJUSTED EXISTING TRAFFIC	1	1186	96	2	0	0	57	1445	1	2	0	0
Background Growth 5.24 %	0	62	0	0	0	0	0	76	0	0	0	0
EXISTING W/ BACKGROUND	1	1248	96	2	0	0	57	1521	1	2	0	0
TOTAL "OTHER" DEVELOPMENTS	0	42	0	0	0	0	0	18	0	0	0	0
FW Triangle - Upper Dublin	0	2	0	0	0	0	0	3	0	0	0	0
Zieger Rose - Upper Dublin	0	11	0	0	0	0	0	6	0	0	0	0
Wawa Retail Site - Horsham	0	2	0	0	0	0	0	2	0	0	0	0
Single Family Homes - Horsham	0	2	0	0	0	0	0	1	0	0	0	0
Horsham Apartments	0	25	0	0	0	0	0	6	0	0	0	0
Other Adjustments	0	0	0	0	0	0	0	0	0	0	0	0
FUTURE TRAFFIC W/O PROJECT	1	1290	96	2	0	0	57	1539	1	2	0	0
TOTAL "NEW" SITE TRAFFIC	0	42	18	83	0	55	64	0	0	0	0	0
Prudential Site	0	42	18	83	0	55	64	0	0	0	0	0
	0	0	0	0	0	0	0	0	0	0	0	0
	0	0	0	0	0	0	0	0	0	0	0	0
	0	0	0	0	0	0	0	0	0	0	0	0
	0	0	0	0	0	0	0	0	0	0	0	0
	0	0	0	0	0	0	0	0	0	0	0	0
	0	0	0	0	0	0	0	0	0	0	0	0
	0	0	0	0	0	0	0	0	0	0	0	0
Pass-By Traffic	0	-8	9	22	0	9	21	-21	0	0	0	0
Other Adjustments	0	-81	-14	0	0	59	64	-64	0	0	0	0
FUTURE TRAFFIC W/ PROJECT	1	1243	109	107	0	123	206	1454	1	2	0	0
"New" Site Traffic % of Total ####	0.0	3.4	16.5	77.6	0.0	44.7	31.1	0.0	0.0	0.0	0.0	0.0

INTERSECTION VOLUME SUMMARY Dryden Road/Welsh Road (S.R. 0063)

Age Restricted Housing Development
 I:\eng\815367\Traffic\Analysis\SDS\SDS Design Year 2023 Residential and Co **Weekday 4-6 PM**
 2023

Traffic Component	EASTBOUND Welsh Road (S.R. 0063)			NORTHBOUND Dryden Road			WESTBOUND Welsh Road (S.R. 0063)			SOUTHBOUND Dryden Road		
	L	S	R	L	S	R	L	S	R	L	S	R
	EXISTING TRAFFIC	0	1557	5	95	8	9	0	1369	0	3	0
Seasonal Adjustment Factor 1.000	0	1557	5	95	8	9	0	1369	0	3	0	1
Balancing Adjustments	0	0	0	0	0	0	0	0	0	0	0	0
ADJUSTED EXISTING TRAFFIC	0	1557	5	95	8	9	0	1369	0	3	0	1
Background Growth 5.24 %	0	82	0	0	0	0	0	72	0	0	0	0
EXISTING W/ BACKGROUND	0	1639	5	95	8	9	0	1441	0	3	0	1
TOTAL "OTHER" DEVELOPMENTS	0	26	0	0	0	0	0	42	0	0	0	0
FW Triangle - Upper Dublin	0	2	0	0	0	0	0	3	0	0	0	0
Zieger Rose - Upper Dublin	0	6	0	0	0	0	0	10	0	0	0	0
Wawa Retail Site - Horsham	0	2	0	0	0	0	0	2	0	0	0	0
Single Family Homes - Horsham	0	2	0	0	0	0	0	2	0	0	0	0
Horsham Apartments	0	14	0	0	0	0	0	25	0	0	0	0
Other Adjustments	0	0	0	0	0	0	0	0	0	0	0	0
FUTURE TRAFFIC W/O PROJECT	0	1665	5	95	8	9	0	1483	0	3	0	1
TOTAL "NEW" SITE TRAFFIC	0	47	39	94	0	62	135	0	0	0	0	0
Prudential Site	0	47	39	94	0	62	135	0	0	0	0	0
	0	0	0	0	0	0	0	0	0	0	0	0
	0	0	0	0	0	0	0	0	0	0	0	0
	0	0	0	0	0	0	0	0	0	0	0	0
	0	0	0	0	0	0	0	0	0	0	0	0
	0	0	0	0	0	0	0	0	0	0	0	0
	0	0	0	0	0	0	0	0	0	0	0	0
	0	0	0	0	0	0	0	0	0	0	0	0
Pass-By Traffic	0	-23	23	38	0	21	39	-39	0	0	0	0
Dryden Road Extension Diversions	0	-71	0	-14	0	70	71	-91	0	0	0	0
FUTURE TRAFFIC W/ PROJECT	0	1618	67	213	8	162	245	1353	0	3	0	1
"New" Site Traffic % of Total ####	0.0	2.9	58.2	44.1	0.0	38.3	55.1	0.0	0.0	0.0	0.0	0.0

INTERSECTION VOLUME SUMMARY Dryden Road/Welsh Road (S.R. 0063)

Age Restricted Housing Development
 I:\eng\815367\TrafficAnalysis\SDS\SDS Design Year 2023 Residential and Co Saturday 11-2 PM
 2023

Traffic Component	EASTBOUND Welsh Road (S.R. 0063)			NORTHBOUND Dryden Road			WESTBOUND Welsh Road (S.R. 0063)			SOUTHBOUND Dryden Road		
	L	S	R	L	S	R	L	S	R	L	S	R
	EXISTING TRAFFIC	2	1034	3	1	0	1	1	1027	2	2	0
Seasonal Adjustment Factor 1.000	2	1034	3	1	0	1	1	1027	2	2	0	2
Balancing Adjustments	0	15	0	0	0	0	0	0	0	0	0	0
ADJUSTED EXISTING TRAFFIC	2	1049	3	1	0	1	1	1027	2	2	0	2
Background Growth 5.24 %	0	55	0	0	0	0	0	54	0	0	0	0
EXISTING W/ BACKGROUND	2	1104	3	1	0	1	1	1081	2	2	0	2
TOTAL "OTHER" DEVELOPMENTS	0	26	0	0	0	0	0	27	0	0	0	0
FW Triangle - Upper Dublin	0	2	0	0	0	0	0	3	0	0	0	0
Zieger Rose - Upper Dublin	0	4	0	0	0	0	0	4	0	0	0	0
Wawa Retail Site - Horsham	0	3	0	0	0	0	0	3	0	0	0	0
Single Family Homes - Horsham	0	2	0	0	0	0	0	2	0	0	0	0
Horsham Apartments	0	15	0	0	0	0	0	15	0	0	0	0
Other Adjustments	0	0	0	0	0	0	0	0	0	0	0	0
FUTURE TRAFFIC W/O PROJECT	2	1130	3	1	0	1	1	1108	2	2	0	2
TOTAL "NEW" SITE TRAFFIC	0	82	58	164	0	109	204	0	0	0	0	0
Prudential Site	0	82	58	164	0	109	204	0	0	0	0	0
	0	0	0	0	0	0	0	0	0	0	0	0
	0	0	0	0	0	0	0	0	0	0	0	0
	0	0	0	0	0	0	0	0	0	0	0	0
	0	0	0	0	0	0	0	0	0	0	0	0
	0	0	0	0	0	0	0	0	0	0	0	0
	0	0	0	0	0	0	0	0	0	0	0	0
	0	0	0	0	0	0	0	0	0	0	0	0
Pass-By Traffic	0	-36	33	60	0	31	66	-66	0	0	0	0
Dryden Road Extension Diversions	0	-47	-1	0	0	47	39	-39	0	0	0	0
FUTURE TRAFFIC W/ PROJECT	2	1129	93	225	0	188	310	1003	2	2	0	2
"New" Site Traffic % of Total ####	0.0	7.3	62.4	72.9	0.0	58.0	65.8	0.0	0.0	0.0	0.0	0.0

INTERSECTION VOLUME SUMMARY Dreshertown Road/Dryden Road Extension

Age Restricted Housing Development
I:\eng\815367\Traffic\Analysis\SDS\SDS Design Year 2023 Residential and C Weekday 7-9 AM
2023

Traffic Component	EASTBOUND Dryden Road Extension			NORTHBOUND Dreshertown Road			WESTBOUND Dryden Road Extension			SOUTHBOUND Dreshertown Road		
	L	S	R	L	S	R	L	S	R	L	S	R
	EXISTING TRAFFIC	0	0	0	0	625	0	0	0	0	0	891
Seasonal Adjustment Factor ####	0	0	0	0	625	0	0	0	0	0	891	0
Balancing Adjustments	0	0	0	0	23	0	0	0	0	0	38	0
ADJUSTED EXISTING TRAFFIC	0	0	0	0	648	0	0	0	0	0	929	0
Background Growth 5.24 %	0	0	0	0	34	0	0	0	0	0	49	0
EXISTING W/ BACKGROUND	0	0	0	0	682	0	0	0	0	0	978	0
TOTAL "OTHER" DEVELOPMENTS	0	0	0	0	14	0	0	0	0	0	26	0
FW Triangle - Upper Dublin	0	0	0	0	5	0	0	0	0	0	6	0
Zieger Rose - Upper Dublin	0	0	0	0	0	0	0	0	0	0	4	0
Wawa Retail Site - Horsham	0	0	0	0	6	0	0	0	0	0	5	0
Single Family Homes - Horsham	0	0	0	0	0	0	0	0	0	0	1	0
Horsham Apartments	0	0	0	0	3	0	0	0	0	0	10	0
Other Adjustments	0	0	0	0	0	0	0	0	0	0	0	0
FUTURE TRAFFIC W/O PROJECT	0	0	0	0	696	0	0	0	0	0	1004	0
TOTAL "NEW" SITE TRAFFIC	0	0	0	0	0	37	55	0	42	27	0	0
Prudential Site	0	0	0	0	0	37	55	0	42	27	0	0
	0	0	0	0	0	0	0	0	0	0	0	0
	0	0	0	0	0	0	0	0	0	0	0	0
	0	0	0	0	0	0	0	0	0	0	0	0
	0	0	0	0	0	0	0	0	0	0	0	0
	0	0	0	0	0	0	0	0	0	0	0	0
	0	0	0	0	0	0	0	0	0	0	0	0
	0	0	0	0	0	0	0	0	0	0	0	0
Pass-By Traffic	0	0	0	0	-9	9	15	0	10	13	-13	0
Dryden Road Extension Diversions	0	0	0	0	-70	70	64	0	0	25	-64	0
FUTURE TRAFFIC W/ PROJECT	0	0	0	0	617	116	134	0	52	65	927	0
"New" Site Traffic % of Total ####	0.0	0.0	0.0	0.0	0.0	31.9	41.0	0.0	80.8	41.5	0.0	0.0

INTERSECTION VOLUME SUMMARY Dreshertown Road/Dryden Road Extension

Age Restricted Housing Development
 I:\eng\815367\Traffic\Analysis\SDS\SDS Design Year 2023 Residential and Cc Weekday 4-6 PM
 2023

Traffic Component	EASTBOUND Dryden Road Extension			NORTHBOUND Dreshertown Road			WESTBOUND Dryden Road Extension			SOUTHBOUND Dreshertown Road		
	L	S	R	L	S	R	L	S	R	L	S	R
EXISTING TRAFFIC	0	0	0	0	816	0	0	0	0	0	980	0
Seasonal Adjustment Factor 1.000	0	0	0	0	816	0	0	0	0	0	980	0
Balancing Adjustments	0	0	0	0	15	0	0	0	0	0	23	0
ADJUSTED EXISTING TRAFFIC	0	0	0	0	831	0	0	0	0	0	1003	0
Background Growth 5.24 %	0	0	0	0	44	0	0	0	0	0	53	0
EXISTING W/ BACKGROUND	0	0	0	0	875	0	0	0	0	0	1056	0
TOTAL "OTHER" DEVELOPMENTS	0	0	0	0	20	0	0	0	0	0	24	0
FW Triangle - Upper Dublin	0	0	0	0	3	0	0	0	0	0	6	0
Zieger Rose - Upper Dublin	0	0	0	0	0	0	0	0	0	0	7	0
Wawa Retail Site - Horsham	0	0	0	0	6	0	0	0	0	0	5	0
Single Family Homes - Horsham	0	0	0	0	1	0	0	0	0	0	1	0
Horsham Apartments	0	0	0	0	10	0	0	0	0	0	5	0
Other Adjustments	0	0	0	0	0	0	0	0	0	0	0	0
FUTURE TRAFFIC W/O PROJECT	0	0	0	0	895	0	0	0	0	0	1080	0
TOTAL "NEW" SITE TRAFFIC	0	0	0	0	0	78	62	0	47	58	0	0
Prudential Site	0	0	0	0	0	78	62	0	47	58	0	0
	0	0	0	0	0	0	0	0	0	0	0	0
	0	0	0	0	0	0	0	0	0	0	0	0
	0	0	0	0	0	0	0	0	0	0	0	0
	0	0	0	0	0	0	0	0	0	0	0	0
	0	0	0	0	0	0	0	0	0	0	0	0
	0	0	0	0	0	0	0	0	0	0	0	0
	0	0	0	0	0	0	0	0	0	0	0	0
Pass-By Traffic	0	0	0	0	-22	22	29	0	22	30	-30	0
Dryden Road Extension Diversions	0	0	0	0	-70	70	81	0	24	1	-81	0
FUTURE TRAFFIC W/ PROJECT	0	0	0	0	803	170	172	0	93	89	969	0
"New" Site Traffic % of Total ###	0.0	0.0	0.0	0.0	0.0	45.9	36.0	0.0	50.5	65.2	0.0	0.0

INTERSECTION VOLUME SUMMARY Dreshertown Road/Dryden Road Extension

Age Restricted Housing Development
 I:\eng\815367\TrafficAnalysis\SDS\SDS Design Year 2023 Residential and Co Saturday 11-2 PM
 2023

Traffic Component	EASTBOUND Dryden Road Extension			NORTHBOUND Dreshertown Road			WESTBOUND Dryden Road Extension			SOUTHBOUND Dreshertown Road		
	L	S	R	L	S	R	L	S	R	L	S	R
	EXISTING TRAFFIC	0	0	0	0	442	0	0	0	0	0	397
Seasonal Adjustment Factor 1.000	0	0	0	0	442	0	0	0	0	0	397	0
Balancing Adjustments	0	0	0	0	3	0	0	0	0	0	0	0
ADJUSTED EXISTING TRAFFIC	0	0	0	0	445	0	0	0	0	0	397	0
Background Growth 5.24 %	0	0	0	0	23	0	0	0	0	0	21	0
EXISTING W/ BACKGROUND	0	0	0	0	468	0	0	0	0	0	418	0
TOTAL "OTHER" DEVELOPMENTS	0	0	0	0	20	0	0	0	0	0	23	0
FW Triangle - Upper Dublin	0	0	0	0	5	0	0	0	0	0	6	0
Zieger Rose - Upper Dublin	0	0	0	0	0	0	0	0	0	0	3	0
Wawa Retail Site - Horsham	0	0	0	0	8	0	0	0	0	0	7	0
Single Family Homes - Horsham	0	0	0	0	1	0	0	0	0	0	1	0
Horsham Apartments	0	0	0	0	6	0	0	0	0	0	6	0
Other Adjustments	0	0	0	0	0	0	0	0	0	0	0	0
FUTURE TRAFFIC W/O PROJECT	0	0	0	0	488	0	0	0	0	0	441	0
TOTAL "NEW" SITE TRAFFIC	0	0	0	0	0	117	109	0	82	88	0	0
Prudential Site	0	0	0	0	0	117	109	0	82	88	0	0
	0	0	0	0	0	0	0	0	0	0	0	0
	0	0	0	0	0	0	0	0	0	0	0	0
	0	0	0	0	0	0	0	0	0	0	0	0
	0	0	0	0	0	0	0	0	0	0	0	0
	0	0	0	0	0	0	0	0	0	0	0	0
	0	0	0	0	0	0	0	0	0	0	0	0
	0	0	0	0	0	0	0	0	0	0	0	0
Pass-By Traffic	0	0	0	0	-28	28	23	0	26	26	-27	0
Dryden Road Extension Diversions	0	0	0	0	-47	47	39	0	0	1	-39	0
FUTURE TRAFFIC W/ PROJECT	0	0	0	0	413	192	171	0	108	115	375	0
"New" Site Traffic % of Total ####	0.0	0.0	0.0	0.0	0.0	60.9	63.7	0.0	75.9	76.5	0.0	0.0

INTERSECTION VOLUME SUMMARY Jarrettown Road/Welsh Road (S.R. 0063)

Age Restricted Housing Development
 I:\eng\815367\TrafficAnalysis\SDS\SDS Design Year 2023 Residential and C Weekday 7-9 AM
 2023

Traffic Component	EASTBOUND Welsh Road (S.R. 0063)			NORTHBOUND Jarrettown Road			WESTBOUND Welsh Road (S.R. 0063)			SOUTHBOUND Jarrettown Road		
	L	S	R	L	S	R	L	S	R	L	S	R
EXISTING TRAFFIC	55	843	14	10	58	309	261	624	8	9	19	27
Seasonal Adjustment Factor ###	55	843	14	10	58	309	261	624	8	9	19	27
Balancing Adjustments	0	0	0	0	0	0	7	18	0	0	0	0
ADJUSTED EXISTING TRAFFIC	55	843	14	10	58	309	268	642	8	9	19	27
Background Growth 5.24 %	3	44	1	1	3	16	14	34	0	0	1	1
EXISTING W/ BACKGROUND	58	887	15	11	61	325	282	676	8	9	20	28
TOTAL "OTHER" DEVELOPMENTS	0	11	4	8	0	20	12	18	0	0	0	0
FW Triangle - Upper Dublin	0	1	0	0	0	0	0	1	0	0	0	0
Zieger Rose - Upper Dublin	0	0	4	8	0	17	5	0	0	0	0	0
Wawa Retail Site - Horsham	0	7	0	0	0	2	2	6	0	0	0	0
Single Family Homes - Horsham	0	0	0	0	0	0	0	1	0	0	0	0
Horsham Apartments	0	3	0	0	0	1	5	10	0	0	0	0
Other Adjustments	0	0	0	0	0	0	0	0	0	0	0	0
FUTURE TRAFFIC W/O PROJECT	58	898	19	19	61	345	294	694	8	9	20	28
TOTAL "NEW" SITE TRAFFIC	0	37	0	0	0	9	14	55	0	0	0	0
Prudential Site	0	37	0	0	0	9	14	55	0	0	0	0
	0	0	0	0	0	0	0	0	0	0	0	0
	0	0	0	0	0	0	0	0	0	0	0	0
	0	0	0	0	0	0	0	0	0	0	0	0
	0	0	0	0	0	0	0	0	0	0	0	0
	0	0	0	0	0	0	0	0	0	0	0	0
	0	0	0	0	0	0	0	0	0	0	0	0
	0	0	0	0	0	0	0	0	0	0	0	0
Pass-By Traffic	0	0	0	0	0	0	0	1	0	0	0	0
Dryden Road Extension Diversions	0	0	0	0	0	0	0	0	0	0	0	0
FUTURE TRAFFIC W/ PROJECT	58	935	19	19	61	354	308	750	8	9	20	28
"New" Site Traffic % of Total ###	0.0	4.0	0.0	0.0	0.0	2.5	4.5	7.3	0.0	0.0	0.0	0.0

INTERSECTION VOLUME SUMMARY Jarrettown Road/Welsh Road (S.R. 0063)

Age Restricted Housing Development
I:\eng\815367\TrafficAnalysis\SDS\SDS Design Year 2023 Residential and Cc **Weekday 4-6 PM**
2023

Traffic Component	EASTBOUND Welsh Road (S.R. 0063)			NORTHBOUND Jarrettown Road			WESTBOUND Welsh Road (S.R. 0063)			SOUTHBOUND Jarrettown Road		
	L	S	R	L	S	R	L	S	R	L	S	R
	EXISTING TRAFFIC	21	661	22	16	20	208	230	905	14	40	89
Seasonal Adjustment Factor 1.000	21	661	22	16	20	208	230	905	14	40	89	103
Balancing Adjustments	0	97	0	0	0	31	12	41	0	0	0	0
ADJUSTED EXISTING TRAFFIC	21	758	22	16	20	239	242	946	14	40	89	103
Background Growth 5.24 %	1	40	1	1	1	13	13	50	1	2	5	5
EXISTING W/ BACKGROUND	22	798	23	17	21	252	255	996	15	42	94	108
TOTAL "OTHER" DEVELOPMENTS	0	20	7	5	0	17	14	12	0	0	0	0
FW Triangle - Upper Dublin	0	2	0	0	0	0	0	1	0	0	0	0
Zieger Rose - Upper Dublin	0	0	7	5	0	10	9	0	0	0	0	0
Wawa Retail Site - Horsham	0	7	0	0	0	2	2	5	0	0	0	0
Single Family Homes - Horsham	0	1	0	0	0	0	0	1	0	0	0	0
Horsham Apartments	0	10	0	0	0	5	3	5	0	0	0	0
Other Adjustments	0	0	0	0	0	0	0	0	0	0	0	0
FUTURE TRAFFIC W/O PROJECT	22	818	30	22	21	269	269	1008	15	42	94	108
TOTAL "NEW" SITE TRAFFIC	0	78	0	0	0	19	16	62	0	0	0	0
Prudential Site	0	78	0	0	0	19	16	62	0	0	0	0
	0	0	0	0	0	0	0	0	0	0	0	0
	0	0	0	0	0	0	0	0	0	0	0	0
	0	0	0	0	0	0	0	0	0	0	0	0
	0	0	0	0	0	0	0	0	0	0	0	0
	0	0	0	0	0	0	0	0	0	0	0	0
	0	0	0	0	0	0	0	0	0	0	0	0
Pass-By Traffic	0	0	0	0	0	0	0	-1	0	0	0	0
Dryden Road Extension Diversions	0	0	0	0	0	0	0	0	0	0	0	0
FUTURE TRAFFIC W/ PROJECT	22	896	30	22	21	288	285	1069	15	42	94	108
"New" Site Traffic % of Total ####	0.0	8.7	0.0	0.0	0.0	6.6	5.6	5.8	0.0	0.0	0.0	0.0

INTERSECTION VOLUME SUMMARY Jarrettown Road/Welsh Road (S.R. 0063)

Age Restricted Housing Development
 I:\eng\815367\Traffic\Analysis\SDS\SDS Design Year 2023 Residential and Co Saturday 11-2 PM
 2023

Traffic Component	EASTBOUND Welsh Road (S.R. 0063)			NORTHBOUND Jarrettown Road			WESTBOUND Welsh Road (S.R. 0063)			SOUTHBOUND Jarrettown Road		
	L	S	R	L	S	R	L	S	R	L	S	R
	EXISTING TRAFFIC	10	574	16	4	2	169	122	533	8	12	2
Seasonal Adjustment Factor 1.000	10	574	16	4	2	169	122	533	8	12	2	7
Balancing Adjustments	0	0	0	0	0	0	1	4	0	0	0	0
ADJUSTED EXISTING TRAFFIC	10	574	16	4	2	169	123	537	8	12	2	7
Background Growth 5.24 %	1	30	1	0	0	9	6	28	0	1	0	0
EXISTING W/ BACKGROUND	11	604	17	4	2	178	129	565	8	13	2	7
TOTAL "OTHER" DEVELOPMENTS	0	18	3	3	0	13	9	16	0	0	0	0
FW Triangle - Upper Dublin	0	2	0	0	0	0	0	1	0	0	0	0
Zieger Rose - Upper Dublin	0	0	3	3	0	7	3	0	0	0	0	0
Wawa Retail Site - Horsham	0	9	0	0	0	3	3	8	0	0	0	0
Single Family Homes - Horsham	0	1	0	0	0	0	0	1	0	0	0	0
Horsham Apartments	0	6	0	0	0	3	3	6	0	0	0	0
Other Adjustments	0	0	0	0	0	0	0	0	0	0	0	0
FUTURE TRAFFIC W/O PROJECT	11	622	20	7	2	191	138	581	8	13	2	7
TOTAL "NEW" SITE TRAFFIC	0	117	0	0	0	29	27	110	0	0	0	0
Prudential Site	0	117	0	0	0	29	27	110	0	0	0	0
	0	0	0	0	0	0	0	0	0	0	0	0
	0	0	0	0	0	0	0	0	0	0	0	0
	0	0	0	0	0	0	0	0	0	0	0	0
	0	0	0	0	0	0	0	0	0	0	0	0
	0	0	0	0	0	0	0	0	0	0	0	0
	0	0	0	0	0	0	0	0	0	0	0	0
	0	0	0	0	0	0	0	0	0	0	0	0
Pass-By Traffic	0	0	0	0	0	0	-1	-3	0	0	0	0
Dryden Road Extension Diversions	0	0	0	0	0	0	0	0	0	0	0	0
FUTURE TRAFFIC W/ PROJECT	11	739	20	7	2	220	164	688	8	13	2	7
"New" Site Traffic % of Total ####	0.0	15.8	0.0	0.0	0.0	13.2	16.5	16.0	0.0	0.0	0.0	0.0

INTERSECTION VOLUME SUMMARY RIRO Access/Welsh Road (S.R. 0063)

Age Restricted Housing Development
I:\eng\815367\Traffic\Analysis\SDS\SDS Design Year 2023 Residential and (Weekday 7-9 AM
2023

Traffic Component	EASTBOUND Welsh Road (S.R. 0063)			NORTHBOUND RIRO Access			WESTBOUND Welsh Road (S.R. 0063)			SOUTHBOUND RIRO Access		
	L	S	R	L	S	R	L	S	R	L	S	R
EXISTING TRAFFIC	0	1283	0	0	0	0	0	1447	0	0	0	0
Seasonal Adjustment Factor ####	0	1283	0	0	0	0	0	1447	0	0	0	0
Balancing Adjustments	0	0	0	0	0	0	0	0	0	0	0	0
ADJUSTED EXISTING TRAFFIC	0	1283	0	0	0	0	0	1447	0	0	0	0
Background Growth 5.24 %	0	67	0	0	0	0	0	76	0	0	0	0
EXISTING W/ BACKGROUND	0	1350	0	0	0	0	0	1523	0	0	0	0
TOTAL "OTHER" DEVELOPMENTS	0	42	0	0	0	0	0	18	0	0	0	0
FW Triangle - Upper Dublin	0	2	0	0	0	0	0	3	0	0	0	0
Zieger Rose - Upper Dublin	0	11	0	0	0	0	0	6	0	0	0	0
Wawa Retail Site - Horsham	0	2	0	0	0	0	0	2	0	0	0	0
Single Family Homes - Horsham	0	2	0	0	0	0	0	1	0	0	0	0
Horsham Apartments	0	25	0	0	0	0	0	6	0	0	0	0
Other Adjustments	0	0	0	0	0	0	0	0	0	0	0	0
FUTURE TRAFFIC W/O PROJECT	0	1392	0	0	0	0	0	1541	0	0	0	0
TOTAL "NEW" SITE TRAFFIC	0	18	37	0	0	42	0	83	0	0	0	0
Prudential Site	0	18	37	0	0	42	0	83	0	0	0	0
	0	0	0	0	0	0	0	0	0	0	0	0
	0	0	0	0	0	0	0	0	0	0	0	0
	0	0	0	0	0	0	0	0	0	0	0	0
	0	0	0	0	0	0	0	0	0	0	0	0
	0	0	0	0	0	0	0	0	0	0	0	0
	0	0	0	0	0	0	0	0	0	0	0	0
	0	0	0	0	0	0	0	0	0	0	0	0
Pass-By Traffic	0	-9	9	0	0	10	0	1	0	0	0	0
Dryden Road Extension Diversions	0	-95	0	0	0	0	0	-64	0	0	0	0
FUTURE TRAFFIC W/ PROJECT	0	1306	46	0	0	52	0	1561	0	0	0	0
"New" Site Traffic % of Total ####	0.0	1.4	80.4	0.0	0.0	80.8	0.0	5.3	0.0	0.0	0.0	0.0

INTERSECTION VOLUME SUMMARY RIRO Access/Welsh Road (S.R. 0063)

Age Restricted Housing Development
I:\eng\815367\Traffic\Analysis\SDS\SDS Design Year 2023 Residential and C Weekday 4-6 PM
2023

Traffic Component	EASTBOUND Welsh Road (S.R. 0063)			NORTHBOUND RIRO Access			WESTBOUND Welsh Road (S.R. 0063)			SOUTHBOUND RIRO Access		
	L	S	R	L	S	R	L	S	R	L	S	R
EXISTING TRAFFIC	0	1562	0	0	0	0	0	1465	0	0	0	0
Seasonal Adjustment Factor 1.000	0	1562	0	0	0	0	0	1465	0	0	0	0
Balancing Adjustments	0	0	0	0	0	0	0	0	0	0	0	0
ADJUSTED EXISTING TRAFFIC	0	1562	0	0	0	0	0	1465	0	0	0	0
Background Growth 5.24 %	0	82	0	0	0	0	0	77	0	0	0	0
EXISTING W/ BACKGROUND	0	1644	0	0	0	0	0	1542	0	0	0	0
TOTAL "OTHER" DEVELOPMENTS	0	26	0	0	0	0	0	42	0	0	0	0
FW Triangle - Upper Dublin	0	2	0	0	0	0	0	3	0	0	0	0
Zieger Rose - Upper Dublin	0	6	0	0	0	0	0	10	0	0	0	0
Wawa Retail Site - Horsham	0	2	0	0	0	0	0	2	0	0	0	0
Single Family Homes - Horsham	0	2	0	0	0	0	0	2	0	0	0	0
Horsham Apartments	0	14	0	0	0	0	0	25	0	0	0	0
Other Adjustments	0	0	0	0	0	0	0	0	0	0	0	0
FUTURE TRAFFIC W/O PROJECT	0	1670	0	0	0	0	0	1584	0	0	0	0
TOTAL "NEW" SITE TRAFFIC	0	39	77	0	0	47	0	94	0	0	0	0
Prudential Site	0	39	77	0	0	47	0	94	0	0	0	0
	0	0	0	0	0	0	0	0	0	0	0	0
	0	0	0	0	0	0	0	0	0	0	0	0
	0	0	0	0	0	0	0	0	0	0	0	0
	0	0	0	0	0	0	0	0	0	0	0	0
	0	0	0	0	0	0	0	0	0	0	0	0
	0	0	0	0	0	0	0	0	0	0	0	0
	0	0	0	0	0	0	0	0	0	0	0	0
Pass-By Traffic	0	-21	21	0	0	21	0	-1	0	0	0	0
Dryden Road Extension Diversions	0	-71	0	0	0	0	0	-105	0	0	0	0
FUTURE TRAFFIC W/ PROJECT	0	1617	98	0	0	68	0	1572	0	0	0	0
"New" Site Traffic % of Total ###	0.0	2.4	78.6	0.0	0.0	69.1	0.0	6.0	0.0	0.0	0.0	0.0

INTERSECTION VOLUME SUMMARY RIRO Access/Welsh Road (S.R. 0063)

Age Restricted Housing Development
I:\eng\815367\Traffic\Analysis\SDS\SDS Design Year 2023 Residential and C Saturday 11-2 PM
2023

Traffic Component	EASTBOUND Welsh Road (S.R. 0063)			NORTHBOUND RIRO Access			WESTBOUND Welsh Road (S.R. 0063)			SOUTHBOUND RIRO Access		
	L	S	R	L	S	R	L	S	R	L	S	R
EXISTING TRAFFIC	0	1039	0	0	0	0	0	1030	0	0	0	0
Seasonal Adjustment Factor 1.000	0	1039	0	0	0	0	0	1030	0	0	0	0
Balancing Adjustments	0	15	0	0	0	0	0	0	0	0	0	0
ADJUSTED EXISTING TRAFFIC	0	1054	0	0	0	0	0	1030	0	0	0	0
Background Growth 5.24 %	0	55	0	0	0	0	0	54	0	0	0	0
EXISTING W/ BACKGROUND	0	1109	0	0	0	0	0	1084	0	0	0	0
TOTAL "OTHER" DEVELOPMENTS	0	26	0	0	0	0	0	27	0	0	0	0
FW Triangle - Upper Dublin	0	2	0	0	0	0	0	3	0	0	0	0
Zieger Rose - Upper Dublin	0	4	0	0	0	0	0	4	0	0	0	0
Wawa Retail Site - Horsham	0	3	0	0	0	0	0	3	0	0	0	0
Single Family Homes - Horsham	0	2	0	0	0	0	0	2	0	0	0	0
Horsham Apartments	0	15	0	0	0	0	0	15	0	0	0	0
Other Adjustments	0	0	0	0	0	0	0	0	0	0	0	0
FUTURE TRAFFIC W/O PROJECT	0	1135	0	0	0	0	0	1111	0	0	0	0
TOTAL "NEW" SITE TRAFFIC	0	58	117	0	0	82	0	164	0	0	0	0
Prudential Site	0	58	117	0	0	82	0	164	0	0	0	0
	0	0	0	0	0	0	0	0	0	0	0	0
	0	0	0	0	0	0	0	0	0	0	0	0
	0	0	0	0	0	0	0	0	0	0	0	0
	0	0	0	0	0	0	0	0	0	0	0	0
	0	0	0	0	0	0	0	0	0	0	0	0
	0	0	0	0	0	0	0	0	0	0	0	0
Pass-By Traffic	0	-34	33	0	0	31	0	-6	0	0	0	0
Dryden Road Extension Diversions	0	-48	0	0	0	0	0	-39	0	0	0	0
FUTURE TRAFFIC W/ PROJECT	0	1111	150	0	0	113	0	1230	0	0	0	0
"New" Site Traffic % of Total ###	0.0	5.2	78.0	0.0	0.0	72.6	0.0	13.3	0.0	0.0	0.0	0.0

APPENDIX H

2018 Future without Development Capacity/Level-of-Service Analysis Worksheets

BT Dreshertown, LP
 1: Jarrettown Road/Village Road & Welsh Road

2018 Without AM Peak



Lane Group	EBL	EBT	EBR	WBL	WBT	WBR	NBL	NBT	NBR	SBL	SBT	SBR
Lane Configurations												
Volume (vph)	56	870	18	285	672	8	18	59	335	9	19	28
Ideal Flow (vphpl)	1800	1800	1800	1800	1800	1800	1800	1800	1800	1800	1800	1800
Lane Width (ft)	12	12	12	11	14	14	12	12	14	15	15	15
Grade (%)		-6%			1%			-1%			1%	
Storage Length (ft)	150		0	100		0	0		175	0		0
Storage Lanes	1		0	1		0	0		1	0		0
Taper Length (ft)	75			75			75			75		
Lane Util. Factor	1.00	1.00	1.00	1.00	1.00	1.00	1.00	1.00	1.00	1.00	1.00	1.00
Frt		0.997			0.998				0.850		0.932	
Flt Protected	0.950			0.950				0.988			0.992	
Satd. Flow (prot)	1727	1810	0	1612	1852	0	0	1760	1640	0	1731	0
Flt Permitted	0.393			0.089				0.920			0.939	
Satd. Flow (perm)	714	1810	0	151	1852	0	0	1639	1640	0	1639	0
Right Turn on Red			Yes			Yes			Yes			Yes
Satd. Flow (RTOR)		1			1				92		29	
Link Speed (mph)		45			45			35			35	
Link Distance (ft)		1263			605			421			431	
Travel Time (s)		19.1			9.2			8.2			8.4	
Peak Hour Factor	0.95	0.95	0.95	0.95	0.95	0.95	0.95	0.95	0.95	0.95	0.95	0.95
Heavy Vehicles (%)	2%	2%	7%	2%	3%	0%	0%	2%	0%	11%	0%	7%
Adj. Flow (vph)	59	916	19	300	707	8	19	62	353	9	20	29
Shared Lane Traffic (%)												
Lane Group Flow (vph)	59	935	0	300	715	0	0	81	353	0	58	0
Number of Detectors	1	2		1	2		1	1	1	1	1	
Detector Template	Left			Left			Left	Thru	Right	Left	Thru	
Leading Detector (ft)	5	330		35	330		20	35	35	20	35	
Trailing Detector (ft)	0	0		-5	0		0	-5	-5	0	-5	
Detector 1 Position (ft)	0	0		-5	0		0	-5	-5	0	-5	
Detector 1 Size (ft)	5	6		40	6		20	40	40	20	40	
Detector 1 Type	CI+Ex	CI+Ex		CI+Ex	CI+Ex		CI+Ex	CI+Ex	CI+Ex	CI+Ex	CI+Ex	
Detector 1 Channel												
Detector 1 Extend (s)	0.0	0.0		0.0	0.0		0.0	0.0	0.0	0.0	0.0	
Detector 1 Queue (s)	0.0	0.0		0.0	0.0		0.0	0.0	0.0	0.0	0.0	
Detector 1 Delay (s)	0.0	0.0		0.0	0.0		0.0	0.0	0.0	0.0	0.0	
Detector 2 Position (ft)		324			324							
Detector 2 Size (ft)		6			6							
Detector 2 Type		CI+Ex			CI+Ex							
Detector 2 Channel												
Detector 2 Extend (s)		0.0			0.0							
Turn Type	Perm	NA		pm+pt	NA		Perm	NA	pm+ov	Perm	NA	
Protected Phases		2		1	6			8	1		4	
Permitted Phases	2			6			8		8	4		
Detector Phase	2	2		1	6		8	8	1	4	4	
Switch Phase												
Minimum Initial (s)	15.0	15.0		3.0	15.0		7.0	7.0	3.0	7.0	7.0	
Minimum Split (s)	22.0	22.0		10.0	22.0		13.0	13.0	10.0	13.0	13.0	
Total Split (s)	65.0	65.0		32.0	97.0		23.0	23.0	32.0	23.0	23.0	
Total Split (%)	54.2%	54.2%		26.7%	80.8%		19.2%	19.2%	26.7%	19.2%	19.2%	

1: Jarrettown Road/Village Road & Welsh Road



Lane Group	EBL	EBT	EBR	WBL	WBT	WBR	NBL	NBT	NBR	SBL	SBT	SBR
Maximum Green (s)	58.0	58.0		25.0	90.0		17.0	17.0	25.0	17.0	17.0	
Yellow Time (s)	5.0	5.0		5.0	5.0		4.0	4.0	5.0	4.0	4.0	
All-Red Time (s)	2.0	2.0		2.0	2.0		2.0	2.0	2.0	2.0	2.0	
Lost Time Adjust (s)	-1.0	-1.0		-1.0	-1.0			-1.0	-1.0			-1.0
Total Lost Time (s)	6.0	6.0		6.0	6.0			5.0	6.0			5.0
Lead/Lag	Lag	Lag		Lead					Lead			
Lead-Lag Optimize?												
Vehicle Extension (s)	3.0	3.0		3.0	3.0		3.0	3.0	3.0	3.0	3.0	
Recall Mode	C-Max	C-Max		None	C-Max		None	None	None	None	None	None

Intersection Summary

Area Type: Other
 Cycle Length: 120
 Actuated Cycle Length: 120
 Offset: 33 (28%), Referenced to phase 2:EBTL and 6:WBTL, Start of 1st Green
 Natural Cycle: 90
 Control Type: Actuated-Coordinated

Splits and Phases: 1: Jarrettown Road/Village Road & Welsh Road

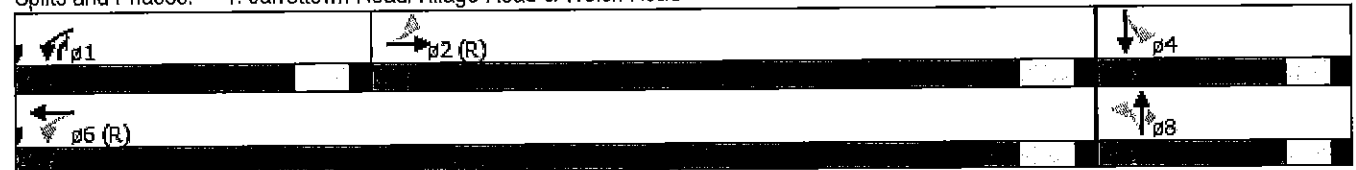

1: Jarrettown Road/Village Road & Welsh Road

Movement	EBl	EBT	EBR	WBL	WBT	WBR	NBL	NET	NBR	SBL	SBT	SBR
Lane Configurations												
Volume (veh/h)	56	870	18	285	672	8	18	59	335	9	19	28
Number	5	2	12	1	6	16	3	8	18	7	4	14
Initial Q (Qb), veh	0	0	0	0	0	0	0	0	0	0	0	0
Ped-Bike Adj(A_pbT)	1.00		1.00	1.00		1.00	1.00		1.00	1.00		1.00
Parking Bus, Adj	1.00	1.00	1.00	1.00	1.00	1.00	1.00	1.00	1.00	1.00	1.00	1.00
Adj Sat Flow, veh/h/ln	1818	1816	1854	1756	1809	1863	1809	1782	1881	1863	1770	1863
Adj Flow Rate, veh/h	59	916	17	300	707	7	19	62	326	9	20	27
Adj No. of Lanes	1	1	0	1	1	0	0	1	1	0	1	0
Peak Hour Factor	0.95	0.95	0.95	0.95	0.95	0.95	0.95	0.95	0.95	0.95	0.95	0.95
Percent Heavy Veh, %	2	2	2	2	3	3	2	2	0	0	0	0
Cap, veh/h	509	1056	20	350	1356	13	75	217	422	53	101	112
Arrive On Green	0.59	0.59	0.59	0.11	0.76	0.75	0.14	0.15	0.15	0.14	0.15	0.14
Sat Flow, veh/h	755	1777	33	1672	1788	18	256	1448	1599	123	676	744
Grp Volume(v), veh/h	59	0	933	300	0	714	81	0	326	56	0	0
Grp Sat Flow(s),veh/h/ln	755	0	1810	1672	0	1806	1704	0	1599	1543	0	0
Q Serve(g_s), s	4.1	0.0	51.8	9.4	0.0	19.0	0.0	0.0	18.0	0.0	0.0	0.0
Cycle Q Clear(g_c), s	4.1	0.0	51.8	9.4	0.0	19.0	4.9	0.0	18.0	3.7	0.0	0.0
Prop In Lane	1.00		0.02	1.00		0.01	0.23		1.00	0.16		0.48
Lane Grp Cap(c), veh/h	509	0	1076	350	0	1369	278	0	422	253	0	0
V/C Ratio(X)	0.12	0.00	0.87	0.86	0.00	0.52	0.29	0.00	0.77	0.22	0.00	0.00
Avail Cap(c_a), veh/h	509	0	1076	521	0	1369	278	0	422	253	0	0
HCM Platoon Ratio	1.00	1.00	1.00	1.00	1.00	1.00	1.00	1.00	1.00	1.00	1.00	1.00
Upstream Filter(I)	1.00	0.00	1.00	1.00	0.00	1.00	1.00	0.00	1.00	1.00	0.00	0.00
Uniform Delay (d), s/veh	10.7	0.0	20.4	28.3	0.0	5.8	45.5	0.0	40.8	45.2	0.0	0.0
Incr Delay (d2), s/veh	0.5	0.0	9.5	9.1	0.0	1.4	0.6	0.0	8.6	0.4	0.0	0.0
Initial Q Delay(d3),s/veh	0.0	0.0	0.0	0.0	0.0	0.0	0.0	0.0	0.0	0.0	0.0	0.0
%ile BackOfQ(95%),veh/ln	1.7	0.0	37.2	15.8	0.0	15.0	4.4	0.0	16.4	3.0	0.0	0.0
LnGrp Delay(d),s/veh	11.2	0.0	29.8	37.4	0.0	7.2	46.1	0.0	49.4	45.6	0.0	0.0
LnGrp LOS	B		C	D		A	D		D	D		
Approach Vol, veh/h		992			1014			407			56	
Approach Delay, s/veh		28.7			16.2			48.7			45.6	
Approach LOS		C			B			D			D	
Timer	1	2	3	4	5	6	7	8				
Assigned Phs	1	2		4		6		8				
Phs Duration (G+Y+Rc), s	19.7	77.3		23.0		97.0		23.0				
Change Period (Y+Rc), s	7.0	7.0		6.0		7.0		6.0				
Max Green Setting (Gmax), s	25.0	58.0		17.0		90.0		17.0				
Max Q Clear Time (g_c+I1), s	11.9	53.8		5.7		21.0		20.5				
Green Ext Time (p_c), s	0.8	4.1		1.4		57.7		0.0				
Intersection Summary												
HCM 2010 Ctrl Delay			27.2									
HCM 2010 LOS			C									

BT Dreshertown, LP
2: Welsh Road & Dresher Road

2018 Without AM Peak

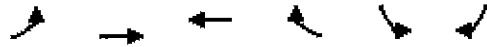

Lane Group	EBL	EBT	WBT	WBR	SBL	SEB
Lane Configurations	↗	↕	↕	↖	↖	↖
Volume (vph)	413	831	704	593	675	310
Ideal Flow (vphpl)	1800	1800	1800	1800	1800	1800
Lane Width (ft)	10	11	11	11	12	13
Grade (%)		-1%	1%		1%	
Storage Length (ft)	225			210	0	415
Storage Lanes	1			1	2	1
Taper Length (ft)	75				75	
Lane Util. Factor	1.00	0.95	0.95	1.00	0.97	1.00
Frt				0.850		0.850
Flt Protected	0.950				0.950	
Satd. Flow (prot)	1588	3290	3194	1443	3268	1542
Flt Permitted	0.207				0.950	
Satd. Flow (perm)	346	3290	3194	1443	3268	1542
Right Turn on Red				Yes		Yes
Satd. Flow (RTOR)				230		41
Link Speed (mph)		45	45		35	
Link Distance (ft)		475	550		970	
Travel Time (s)		7.2	8.3		18.9	
Peak Hour Factor	0.94	0.94	0.94	0.94	0.94	0.94
Heavy Vehicles (%)	1%	1%	3%	2%	1%	2%
Adj. Flow (vph)	439	884	749	631	718	330
Shared Lane Traffic (%)						
Lane Group Flow (vph)	439	884	749	631	718	330
Number of Detectors	1	1	1	1	1	1
Detector Template						
Leading Detector (ft)	35	5	5	5	35	35
Trailing Detector (ft)	-5	0	0	0	-5	-5
Detector 1 Position(ft)	-5	0	0	0	-5	-5
Detector 1 Size(ft)	40	5	5	5	40	40
Detector 1 Type	CI+Ex	CI+Ex	CI+Ex	CI+Ex	CI+Ex	CI+Ex
Detector 1 Channel						
Detector 1 Extend (s)	0.0	0.0	0.0	0.0	0.0	0.0
Detector 1 Queue (s)	0.0	0.0	0.0	0.0	0.0	0.0
Detector 1 Delay (s)	0.0	0.0	0.0	0.0	0.0	0.0
Turn Type	pm+pt	NA	NA	pm+ov	Prot	pm+ov
Protected Phases	5	2	6	4	4	5
Permitted Phases	2			6		4
Detector Phase	5	2	6	4	4	5
Switch Phase						
Minimum Initial (s)	3.0	20.0	20.0	7.0	7.0	3.0
Minimum Split (s)	9.0	26.0	26.0	14.0	14.0	9.0
Total Split (s)	40.0	82.0	42.0	38.0	38.0	40.0
Total Split (%)	33.3%	68.3%	35.0%	31.7%	31.7%	33.3%
Maximum Green (s)	34.0	76.0	36.0	31.0	31.0	34.0
Yellow Time (s)	4.0	4.0	4.0	4.0	4.0	4.0
All-Red Time (s)	2.0	2.0	2.0	3.0	3.0	2.0
Lost Time Adjust (s)	-1.0	-1.0	-1.0	-1.0	-1.0	-1.0
Total Lost Time (s)	5.0	5.0	5.0	6.0	6.0	5.0

BT Dreshertown, LP
2: Welsh Road & Dresher Road

2018 Without AM Peak



Lane Group	EBL	EPT	WBT	WBR	SEB	SEB
Lead/Lag	Lead		Lag		Lead	
Lead-Lag Optimize?						
Vehicle Extension (s)	3.0	3.0	3.0	3.0	3.0	3.0
Recall Mode	None	C-Max	C-Max	None	None	None
Act Effct Green (s)	77.9	77.9	43.8	80.0	31.1	66.2
Actuated g/C Ratio	0.65	0.65	0.36	0.67	0.26	0.55
v/c Ratio	0.84	0.41	0.64	0.61	0.85	0.38
Control Delay	25.6	6.2	37.6	14.4	52.6	13.6
Queue Delay	0.0	0.1	0.0	0.4	0.0	0.0
Total Delay	25.6	6.3	37.6	14.7	52.6	13.6
LOS	C	A	D	B	D	B
Approach Delay		12.7	27.1		40.3	
Approach LOS		B	C		D	
Queue Length 50th (ft)	151	90	281	214	270	111
Queue Length 95th (ft)	m224	m98	362	379	344	160
Internal Link Dist (ft)		395	470		890	
Turn Bay Length (ft)	225			210		415
Base Capacity (vph)	586	2134	1166	1047	871	943
Starvation Cap Reductn	0	0	0	108	0	0
Spillback Cap Reductn	0	186	0	0	0	0
Storage Cap Reductn	0	0	0	0	0	0
Reduced v/c Ratio	0.75	0.45	0.64	0.67	0.82	0.35

Intersection Summary

Area Type: Other
 Cycle Length: 120
 Actuated Cycle Length: 120
 Offset: 85 (71%), Referenced to phase 2:EBTL and 6:WBT, Start of 1st Green
 Natural Cycle: 80
 Control Type: Actuated-Coordinated
 Maximum v/c Ratio: 0.85
 Intersection Signal Delay: 25.7
 Intersection Capacity Utilization 78.4%
 Analysis Period (min) 15
 m Volume for 95th percentile queue is metered by upstream signal.

Intersection LOS: C
 ICU Level of Service D

Splits and Phases: 2: Welsh Road & Dresher Road



BT Dreshertown, LP
3: Dreshertown Road & Welsh Road

2018 Without AM Peak



Lane Group	EBT	EBR	WBL	WBT	NBL	NEB
Lane Configurations	↑↑	↑	↓	↑↑	↓↑	↑
Volume (vph)	954	552	421	1009	289	384
Ideal Flow (vphpl)	1800	1800	1800	1800	1800	1800
Lane Width (ft)	11	15	10	12	12	15
Grade (%)	-2%			1%	1%	
Storage Length (ft)		150	175		0	350
Storage Lanes		1	1		2	2
Taper Length (ft)			75		75	
Lane Util. Factor	0.95	1.00	1.00	0.95	0.97	1.00
Frt		0.850				0.850
Flt Protected			0.950		0.950	
Satd. Flow (prot)	3306	1650	1542	3304	3174	1626
Flt Permitted			0.177		0.950	
Satd. Flow (perm)	3306	1650	287	3304	3174	1626
Right Turn on Red		Yes				Yes
Satd. Flow (RTOR)		380				38
Link Speed (mph)	45			45	40	
Link Distance (ft)	550			1040	778	
Travel Time (s)	8.3			15.8	13.3	
Peak Hour Factor	0.98	0.98	0.98	0.98	0.98	0.98
Heavy Vehicles (%)	1%	3%	3%	3%	4%	3%
Adj. Flow (vph)	973	563	430	1030	295	392
Shared Lane Traffic (%)						
Lane Group Flow (vph)	973	563	430	1030	295	392
Number of Detectors	1	1	1	1	1	1
Detector Template						
Leading Detector (ft)	5	5	35	5	35	35
Trailing Detector (ft)	0	0	-5	0	-5	-5
Detector 1 Position(ft)	0	0	-5	0	-5	-5
Detector 1 Size(ft)	5	5	40	5	40	40
Detector 1 Type	CI+Ex	CI+Ex	CI+Ex	CI+Ex	CI+Ex	CI+Ex
Detector 1 Channel						
Detector 1 Extend (s)	0.0	0.0	0.0	0.0	0.0	0.0
Detector 1 Queue (s)	0.0	0.0	0.0	0.0	0.0	0.0
Detector 1 Delay (s)	0.0	0.0	0.0	0.0	0.0	0.0
Turn Type	NA	Perm	pm+pt	NA	Prot	pm+ov
Protected Phases	2		1	6	8	1
Permitted Phases		2	6			8
Detector Phase	2	2	1	6	8	1
Switch Phase						
Minimum Initial (s)	20.0	20.0	3.0	20.0	7.0	3.0
Minimum Split (s)	27.0	27.0	10.0	27.0	14.0	10.0
Total Split (s)	53.0	53.0	45.0	98.0	22.0	45.0
Total Split (%)	44.2%	44.2%	37.5%	81.7%	18.3%	37.5%
Maximum Green (s)	46.0	46.0	38.0	91.0	15.0	38.0
Yellow Time (s)	5.0	5.0	5.0	5.0	4.0	5.0
All-Red Time (s)	2.0	2.0	2.0	2.0	3.0	2.0
Lost Time Adjust (s)	-1.0	-1.0	-1.0	-1.0	-1.0	-1.0
Total Lost Time (s)	6.0	6.0	6.0	6.0	6.0	6.0

BT Dreshertown, LP
 3: Dreshertown Road & Welsh Road

2018 Without AM Peak



Lane Group	EBT	EBR	WBL	WBT	INBL	NBR
Lead/Lag	Lag	Lag	Lead			Lead
Lead-Lag Optimize?						
Vehicle Extension (s)	3.0	3.0	3.0	3.0	3.0	3.0
Recall Mode	C-Max	C-Max	None	C-Max	None	None

Intersection Summary

Area Type: Other
 Cycle Length: 120
 Actuated Cycle Length: 120
 Offset: 85 (71%), Referenced to phase 2:EBT and 6:WBTL, Start of 1st Green
 Natural Cycle: 65
 Control Type: Actuated-Coordinated

Splits and Phases: 3: Dreshertown Road & Welsh Road

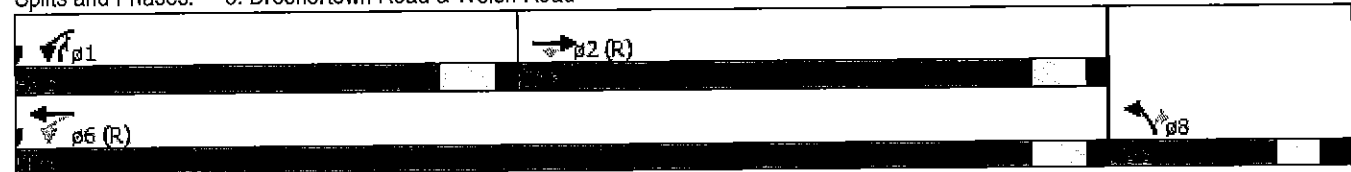



Movement	EBT	EBR	WBL	WBT	NBL	NBR
Lane Configurations	↑↑	↑	↑	↑↑	↑↑	↑
Volume (veh/h)	954	552	421	1009	289	384
Number	2	12	1	6	3	18
Initial Q (Qb), veh	0	0	0	0	0	0
Ped-Bike Adj(A_pbT)		1.00	1.00		1.00	1.00
Parking Bus, Adj	1.00	1.00	1.00	1.00	1.00	1.00
Adj Sat Flow, veh/h/ln	1800	1836	1739	1739	1722	1808
Adj Flow Rate, veh/h	973	519	430	1030	295	309
Adj No. of Lanes	2	1	1	2	2	1
Peak Hour Factor	0.98	0.98	0.98	0.98	0.98	0.98
Percent Heavy Veh, %	1	3	3	3	4	3
Cap, veh/h	1915	874	513	2533	424	446
Arrive On Green	1.00	1.00	0.31	1.00	0.13	0.13
Sat Flow, veh/h	3510	1560	1656	3391	3182	1537
Grp Volume(v), veh/h	973	519	430	1030	295	309
Grp Sat Flow(s),veh/h/ln	1710	1560	1656	1652	1591	1537
Q Serve(g_s), s	0.0	0.0	13.9	0.0	10.6	16.0
Cycle Q Clear(g_c), s	0.0	0.0	13.9	0.0	10.6	16.0
Prop In Lane		1.00	1.00		1.00	1.00
Lane Grp Cap(c), veh/h	1915	874	513	2533	424	446
V/C Ratio(X)	0.51	0.59	0.84	0.41	0.70	0.69
Avail Cap(c_a), veh/h	1915	874	792	2533	424	446
HCM Platoon Ratio	2.00	2.00	2.00	2.00	1.00	1.00
Upstream Filter(I)	0.76	0.76	0.87	0.87	1.00	1.00
Uniform Delay (d), s/veh	0.0	0.0	6.2	0.0	49.7	37.8
Incr Delay (d2), s/veh	0.7	2.3	4.2	0.4	4.9	4.6
Initial Q Delay(d3),s/veh	0.0	0.0	0.0	0.0	0.0	0.0
%ile BackOfQ(95%),veh/ln	0.4	1.0	11.4	0.3	8.6	14.8
LnGrp Delay(d),s/veh	0.7	2.3	10.4	0.4	54.6	42.4
LnGrp LOS	A	A	B	A	D	D
Approach Vol, veh/h	1492			1460	604	
Approach Delay, s/veh	1.3			3.4	48.3	
Approach LOS	A			A	D	

Timer	1	2	3	4	5	6	7	8
Assigned Phs	1	2				6		8
Phs Duration (G+Y+Rc), s	24.8	73.2				98.0		22.0
Change Period (Y+Rc), s	7.0	7.0				7.0		7.0
Max Green Setting (Gmax), s	38.0	46.0				91.0		15.0
Max Q Clear Time (g_c+I1), s	16.4	2.5				2.5		18.5
Green Ext Time (p_c), s	1.5	11.7				12.3		0.0

Intersection Summary	
HCM 2010 Ctrl Delay	10.1
HCM 2010 LOS	B

BT Dreshertown, LP
4: Dryden Road & Welsh Road

2018 Without AM Peak



Lane Group	EBL	EBT	EBR	WBL	WBT	WBR	NBL	NBT	NBR	SBL	SBT	SBR
Lane Configurations	↖	↗	↘	↖	↗	↘	↖	↗	↘	↖	↗	↘
Volume (vph)	1	1251	96	57	1491	1800	1800	1800	1800	1800	1800	1800
Ideal Flow (vphpl)	1800	1800	1800	1800	1800	1800	1800	1800	1800	1800	1800	1800
Lane Width (ft)	10	12	14	10	12	12	11	15	15	12	14	14
Grade (%)		-1%			-1%			-1%			0%	
Storage Length (ft)	150		225	175		0	110		0	150		0
Storage Lanes	1		1	1		0	1		0	1		0
Taper Length (ft)	75			75			75			75		
Lane Util. Factor	1.00	0.95	1.00	1.00	0.95	0.95	1.00	1.00	1.00	1.00	1.00	1.00
Frt			0.850									
Flt Protected	0.950			0.950			0.950			0.950		
Satd. Flow (prot)	1604	3403	1640	1573	3370	0	1661	1990	0	1710	1920	0
Flt Permitted	0.147			0.197								
Satd. Flow (perm)	248	3403	1640	326	3370	0	1749	1990	0	1800	1920	0
Right Turn on Red			Yes			Yes			Yes			Yes
Satd. Flow (RTOR)			103									
Link Speed (mph)		45			45			25			25	
Link Distance (ft)		1040			1416			754			960	
Travel Time (s)		15.8			21.5			20.6			26.2	
Peak Hour Factor	0.93	0.93	0.93	0.93	0.93	0.93	0.93	0.93	0.93	0.93	0.93	0.93
Heavy Vehicles (%)	0%	1%	0%	2%	2%	0%	0%	0%	0%	0%	0%	0%
Adj. Flow (vph)	1	1345	103	61	1603	1	2	0	0	2	0	0
Shared Lane Traffic (%)												
Lane Group Flow (vph)	1	1345	103	61	1604	0	2	0	0	2	0	0
Number of Detectors	1	1	1	1	1		1	1		1	1	
Detector Template												
Leading Detector (ft)	5	5	5	5	5		35	35		35	35	
Trailing Detector (ft)	0	0	0	0	0		-5	-5		-5	-5	
Detector 1 Position(ft)	0	0	0	0	0		-5	-5		-5	-5	
Detector 1 Size(ft)	5	5	5	5	5		40	40		40	40	
Detector 1 Type	CI+Ex	CI+Ex	CI+Ex	CI+Ex	CI+Ex		CI+Ex	CI+Ex		CI+Ex	CI+Ex	
Detector 1 Channel												
Detector 1 Extend (s)	0.0	0.0	0.0	0.0	0.0		0.0	0.0		0.0	0.0	
Detector 1 Queue (s)	0.0	0.0	0.0	0.0	0.0		0.0	0.0		0.0	0.0	
Detector 1 Delay (s)	0.0	0.0	0.0	0.0	0.0		0.0	0.0		0.0	0.0	
Turn Type	Perm	NA	Perm	Perm	NA		Perm			Perm		
Protected Phases		2			6			8			4	
Permitted Phases	2		2	6			8			4		
Detector Phase	2	2	2	6	6		8	8		4	4	
Switch Phase												
Minimum Initial (s)	21.0	21.0	21.0	21.0	21.0		5.0	5.0		5.0	5.0	
Minimum Split (s)	27.0	27.0	27.0	27.0	27.0		11.0	11.0		11.0	11.0	
Total Split (s)	107.0	107.0	107.0	107.0	107.0		13.0	13.0		13.0	13.0	
Total Split (%)	89.2%	89.2%	89.2%	89.2%	89.2%		10.8%	10.8%		10.8%	10.8%	
Maximum Green (s)	101.0	101.0	101.0	101.0	101.0		7.0	7.0		7.0	7.0	
Yellow Time (s)	4.0	4.0	4.0	4.0	4.0		3.0	3.0		3.0	3.0	
All-Red Time (s)	2.0	2.0	2.0	2.0	2.0		3.0	3.0		3.0	3.0	
Lost Time Adjust (s)	-1.0	-1.0	-1.0	-1.0	-1.0		-1.0	-1.0		-1.0	-1.0	
Total Lost Time (s)	5.0	5.0	5.0	5.0	5.0		5.0	5.0		5.0	5.0	

BT Dreshertown, LP
 4: Dryden Road & Welsh Road

2018 Without AM Peak



Lane Group	EBL	EBT	EBR	WBL	WBT	WBR	INBL	INBT	INBR	SBL	SBT	SBR
Lead/Lag												
Lead-Lag Optimize?												
Vehicle Extension (s)	3.0	3.0	3.0	3.0	3.0		3.0	3.0		3.0	3.0	
Recall Mode	C-Max	C-Max	C-Max	C-Max	C-Max		None	None		None	None	

Intersection Summary

Area Type: Other
 Cycle Length: 120
 Actuated Cycle Length: 120
 Offset: 62 (52%), Referenced to phase 2:EBTL and 6:WBTL, Start of 1st Green
 Natural Cycle: 45
 Control Type: Actuated-Coordinated

Splits and Phases: 4: Dryden Road & Welsh Road



BT Dreshertown, LP
4: Dryden Road & Welsh Road

2018 Without AM Peak

Movement	EBL	EBT	EBR	WBL	WBT	WBR	NBL	NBT	NBR	SBL	SBT	SBR
Lane Configurations												
Volume (veh/h)	1	1251	96	57	1491	1	2	0	0	2	0	0
Number	5	2	12	1	6	16	3	8	18	7	4	14
Initial Q (Qb), veh	0	0	0	0	0	0	0	0	0	0	0	0
Ped-Bike Adj(A_pbT)	1.00		1.00	1.00		1.00	1.00		1.00	1.00		1.00
Parking Bus, Adj	1.00	1.00	1.00	1.00	1.00	1.00	1.00	1.00	1.00	1.00	1.00	1.00
Adj Sat Flow, veh/h/ln	1809	1791	1881	1774	1774	1809	1809	1881	1881	1800	1872	1872
Adj Flow Rate, veh/h	1	1345	101	61	1603	1	2	0	0	2	0	0
Adj No. of Lanes	1	2	1	1	2	0	1	1	0	1	1	0
Peak Hour Factor	0.93	0.93	0.93	0.93	0.93	0.93	0.93	0.93	0.93	0.93	0.93	0.93
Percent Heavy Veh. %	0	1	0	2	2	2	0	0	0	0	0	0
Cap, veh/h	325	3073	1444	393	3121	2	80	25	0	79	25	0
Arrive On Green	1.00	1.00	1.00	0.90	0.90	0.89	0.01	0.00	0.00	0.01	0.00	0.00
Sat Flow, veh/h	323	3403	1599	369	3456	2	1447	1881	0	1440	1872	0
Grp Volume(v), veh/h	1	1345	101	61	781	823	2	0	0	2	0	0
Grp Sat Flow(s),veh/h/ln	323	1702	1599	369	1685	1773	1447	1881	0	1440	1872	0
Q Serve(g_s), s	0.0	0.0	0.0	2.3	10.1	10.1	0.2	0.0	0.0	0.2	0.0	0.0
Cycle Q Clear(g_c), s	10.1	0.0	0.0	2.3	10.1	10.1	0.2	0.0	0.0	0.2	0.0	0.0
Prop In Lane	1.00		1.00	1.00		0.00	1.00		0.00	1.00		0.00
Lane Grp Cap(c), veh/h	325	3073	1444	393	1522	1601	80	25	0	79	25	0
V/C Ratio(X)	0.00	0.44	0.07	0.16	0.51	0.51	0.03	0.00	0.00	0.03	0.00	0.00
Avail Cap(c_a), veh/h	325	3073	1444	393	1522	1601	156	125	0	156	125	0
HCM Platoon Ratio	2.00	2.00	2.00	1.00	1.00	1.00	1.00	1.00	1.00	1.00	1.00	1.00
Upstream Filter(I)	0.77	0.77	0.77	1.00	1.00	1.00	1.00	0.00	0.00	1.00	0.00	0.00
Uniform Delay (d), s/veh	0.5	0.0	0.0	0.7	1.1	1.1	58.5	0.0	0.0	58.5	0.0	0.0
Incr Delay (d2), s/veh	0.0	0.3	0.1	0.8	1.2	1.2	0.1	0.0	0.0	0.1	0.0	0.0
Initial Q Delay(d3),s/veh	0.0	0.0	0.0	0.0	0.0	0.0	0.0	0.0	0.0	0.0	0.0	0.0
%ile BackOfQ(95%),veh/ln	0.0	0.3	0.1	0.6	8.5	8.8	0.1	0.0	0.0	0.1	0.0	0.0
LnGrp Delay(d),s/veh	0.5	0.3	0.1	1.5	2.3	2.2	58.6	0.0	0.0	58.6	0.0	0.0
LnGrp LOS	A	A	A	A	A	A	E			E		
Approach Vol, veh/h		1447			1665			2			2	
Approach Delay, s/veh		0.3			2.2			58.6			58.6	
Approach LOS		A			A			E			E	
Turner	1	2	3	4	5	6	7	8				
Assigned Phs		2		4		6		8				
Phs Duration (G+Y+Rc), s		113.4		6.6		113.4		6.6				
Change Period (Y+Rc), s		6.0		6.0		6.0		6.0				
Max Green Setting (Gmax), s		101.0		7.0		101.0		7.0				
Max Q Clear Time (g_c+I1), s		12.6		2.7		12.6		2.7				
Green Ext Time (p_c), s		20.0		0.0		20.0		0.0				
Intersection Summary												
HCM 2010 Ctrl Delay			1.4									
HCM 2010 LOS			A									

1: Jarrettown Road/Village Road & Welsh Road



Lane Group	EBL	EBT	EBR	WBL	WBT	WBR	NBL	NBT	NBR	SBL	SBT	SBR
Lane Configurations												
Volume (vph)	21	793	29	261	976	14	21	20	261	41	91	105
Ideal Flow (vphpl)	1800	1800	1800	1800	1800	1800	1800	1800	1800	1800	1800	1800
Lane Width (ft)	12	12	12	11	14	14	12	12	14	15	15	15
Grade (%)		-6%			1%			-1%			1%	
Storage Length (ft)	150		0	100		0	0		175	0		0
Storage Lanes	1		0	1		0	0		1	0		0
Taper Length (ft)	75			75			75			75		
Lane Util. Factor	1.00	1.00	1.00	1.00	1.00	1.00	1.00	1.00	1.00	1.00	1.00	1.00
Frt		0.995			0.998				0.850		0.940	
Flt Protected	0.950			0.950				0.975			0.991	
Satd. Flow (prot)	1761	1827	0	1645	1907	0	0	1764	1640	0	1826	0
Flt Permitted	0.232			0.090				0.650			0.935	
Satd. Flow (perm)	430	1827	0	156	1907	0	0	1176	1640	0	1723	0
Right Turn on Red			Yes			Yes			Yes			Yes
Satd. Flow (RTOR)		2			1				100		31	
Link Speed (mph)		45			45			35			35	
Link Distance (ft)		1263			605			421			431	
Travel Time (s)		19.1			9.2			8.2			8.4	
Peak Hour Factor	0.96	0.96	0.96	0.96	0.96	0.96	0.96	0.96	0.96	0.96	0.96	0.96
Heavy Vehicles (%)	0%	1%	0%	0%	0%	0%	0%	0%	0%	3%	0%	0%
Adj. Flow (vph)	22	826	30	272	1017	15	22	21	272	43	95	109
Shared Lane Traffic (%)												
Lane Group Flow (vph)	22	856	0	272	1032	0	0	43	272	0	247	0
Number of Detectors	1	2		1	2		1	1	1	1	1	
Detector Template	Left			Left			Left	Thru	Right	Left	Thru	
Leading Detector (ft)	5	330		35	330		20	35	35	20	35	
Trailing Detector (ft)	0	0		-5	0		0	-5	-5	0	-5	
Detector 1 Position(ft)	0	0		-5	0		0	-5	-5	0	-5	
Detector 1 Size(ft)	5	6		40	6		20	40	40	20	40	
Detector 1 Type	CI+Ex	CI+Ex		CI+Ex	CI+Ex		CI+Ex	CI+Ex	CI+Ex	CI+Ex	CI+Ex	
Detector 1 Channel												
Detector 1 Extend (s)	0.0	0.0		0.0	0.0		0.0	0.0	0.0	0.0	0.0	
Detector 1 Queue (s)	0.0	0.0		0.0	0.0		0.0	0.0	0.0	0.0	0.0	
Detector 1 Delay (s)	0.0	0.0		0.0	0.0		0.0	0.0	0.0	0.0	0.0	
Detector 2 Position(ft)		324			324							
Detector 2 Size(ft)		6			6							
Detector 2 Type		CI+Ex			CI+Ex							
Detector 2 Channel												
Detector 2 Extend (s)		0.0			0.0							
Turn Type	Perm	NA		pm+pt	NA		Perm	NA	pm+ov	Perm	NA	
Protected Phases		2		1	6			8	1		4	
Permitted Phases	2			6			8		8	4		
Detector Phase	2	2		1	6		8	8	1	4	4	
Switch Phase												
Minimum Initial (s)	15.0	15.0		3.0	15.0		7.0	7.0	3.0	7.0	7.0	
Minimum Split (s)	22.0	22.0		10.0	22.0		13.0	13.0	10.0	13.0	13.0	
Total Split (s)	61.0	61.0		26.0	87.0		33.0	33.0	26.0	33.0	33.0	
Total Split (%)	50.8%	50.8%		21.7%	72.5%		27.5%	27.5%	21.7%	27.5%	27.5%	

1: Jarrettown Road/Village Road & Welsh Road



Lane Group	EBL	EBT	EBR	WBL	WBT	WBR	NBL	NBT	NBR	SBL	SBT	SBR
Maximum Green (s)	54.0	54.0		19.0	80.0		27.0	27.0	19.0	27.0	27.0	
Yellow Time (s)	5.0	5.0		5.0	5.0		4.0	4.0	5.0	4.0	4.0	
All-Red Time (s)	2.0	2.0		2.0	2.0		2.0	2.0	2.0	2.0	2.0	
Lost Time Adjust (s)	-1.0	-1.0		-1.0	-1.0			-1.0	-1.0			-1.0
Total Lost Time (s)	6.0	6.0		6.0	6.0			5.0	6.0			5.0
Lead/Lag	Lag	Lag		Lead					Lead			
Lead-Lag Optimize?												
Vehicle Extension (s)	3.0	3.0		3.0	3.0		3.0	3.0	3.0	3.0	3.0	
Recall Mode	C-Max	C-Max		None	C-Max		None	None	None	None	None	None

Intersection Summary

Area Type: Other
 Cycle Length: 120
 Actuated Cycle Length: 120
 Offset: 5 (4%), Referenced to phase 2:EBTL and 6:WBTL, Start of 1st Green
 Natural Cycle: 90
 Control Type: Actuated-Coordinated

Splits and Phases: 1: Jarrettown Road/Village Road & Welsh Road



1: Jarrettown Road/Village Road & Welsh Road

Movement	EBL	EBT	EBR	WBL	WBT	WBR	NBL	NBT	NBR	SBL	SBT	SBR
Lane Configurations												
Volume (veh/h)	21	793	29	261	976	14	21	20	261	41	91	105
Number	5	2	12	1	6	16	3	8	18	7	4	14
Initial Q (Qb), veh	0	0	0	0	0	0	0	0	0	0	0	0
Ped-Bike Adj(A_pbT)	1.00		1.00	1.00		1.00	1.00		1.00	1.00		1.00
Parking Bus, Adj	1.00	1.00	1.00	1.00	1.00	1.00	1.00	1.00	1.00	1.00	1.00	1.00
Adj Sat Flow, veh/h/ln	1854	1836	1854	1791	1863	1863	1809	1809	1881	1863	1853	1863
Adj Flow Rate, veh/h	22	826	29	272	1017	14	22	21	251	43	95	95
Adj No. of Lanes	1	1	0	1	1	0	0	1	1	0	1	0
Peak Hour Factor	0.96	0.96	0.96	0.96	0.96	0.96	0.96	0.96	0.96	0.96	0.96	0.96
Percent Heavy Veh, %	0	1	1	0	0	0	0	0	0	0	0	0
Cap, veh/h	289	1042	37	368	1341	18	126	107	428	74	129	116
Arrive On Green	0.59	0.59	0.58	0.09	0.73	0.72	0.17	0.18	0.18	0.17	0.18	0.17
Sat Flow, veh/h	572	1763	62	1706	1833	25	454	604	1599	219	732	655
Grp Volume(v), veh/h	22	0	855	272	0	1031	43	0	251	233	0	0
Grp Sat Flow(s), veh/h/ln	572	0	1825	1706	0	1858	1059	0	1599	1606	0	0
Q Serve(g_s), s	2.9	0.0	43.3	6.8	0.0	40.2	0.0	0.0	16.4	11.9	0.0	0.0
Cycle Q Clear(g_c), s	25.7	0.0	43.3	6.8	0.0	40.2	3.0	0.0	16.4	16.8	0.0	0.0
Prop In Lane	1.00		0.03	1.00		0.01	0.51		1.00	0.18		0.41
Lane Grp Cap(c), veh/h	289	0	1078	368	0	1359	224	0	428	306	0	0
V/C Ratio(X)	0.08	0.00	0.79	0.74	0.00	0.76	0.19	0.00	0.59	0.76	0.00	0.00
Avail Cap(c_a), veh/h	289	0	1078	497	0	1359	306	0	518	395	0	0
HCM Platoon Ratio	1.00	1.00	1.00	1.00	1.00	1.00	1.00	1.00	1.00	1.00	1.00	1.00
Upstream Filter(I)	1.00	0.00	1.00	1.00	0.00	1.00	1.00	0.00	1.00	1.00	0.00	0.00
Uniform Delay (d), s/veh	22.4	0.0	18.9	20.9	0.0	9.7	41.9	0.0	38.2	47.7	0.0	0.0
Incr Delay (d2), s/veh	0.5	0.0	6.0	3.9	0.0	4.0	0.4	0.0	1.3	6.3	0.0	0.0
Initial Q Delay(d3),s/veh	0.0	0.0	0.0	0.0	0.0	0.0	0.0	0.0	0.0	0.0	0.0	0.0
%ile BackOfQ(95%),veh/ln	0.9	0.0	31.3	9.9	0.0	29.5	2.3	0.0	11.9	12.8	0.0	0.0
LnGrp Delay(d),s/veh	22.9	0.0	24.9	24.8	0.0	13.7	42.3	0.0	39.5	54.0	0.0	0.0
LnGrp LOS	C		C	C		B	D		D	D		
Approach Vol, veh/h		877			1303			294				233
Approach Delay, s/veh		24.9			16.0			39.9				54.0
Approach LOS		C			B			D				D
Timer	1	2	3	4	5	6	7	8				
Assigned Phs	1	2		4		6		8				
Phs Duration (G+Y+Rc), s	16.9	76.9		26.2		93.8		26.2				
Change Period (Y+Rc), s	7.0	7.0		6.0		7.0		6.0				
Max Green Setting (Gmax), s	19.0	54.0		27.0		80.0		27.0				
Max Q Clear Time (g_c+I1), s	9.3	45.3		18.8		42.2		18.9				
Green Ext Time (p_c), s	0.6	8.6		1.4		35.9		1.4				
Intersection Summary												
HCM 2010 Ctrl Delay			24.8									
HCM 2010 LOS			C									

BT Dreshertown, LP
2: Welsh Road & Dresher Road

2018 Without PM Peak



Lane Group	EBL	EBT	WBT	WBR	SBL	SBR
Lane Configurations	↖	↕	↕	↗	↖	↗
Volume (vph)	306	844	902	579	861	413
Ideal Flow (vphpl)	1800	1800	1800	1800	1800	1800
Lane Width (ft)	10	11	11	11	12	13
Grade (%)		-1%	1%		1%	
Storage Length (ft)	225			210	0	415
Storage Lanes	1			1	2	1
Taper Length (ft)	75				75	
Lane Util. Factor	1.00	0.95	0.95	1.00	0.97	1.00
Fr				0.850		0.850
Flt Protected	0.950				0.950	
Satd. Flow (prot)	1588	3257	3257	1457	3268	1558
Flt Permitted	0.123				0.950	
Satd. Flow (perm)	206	3257	3257	1457	3268	1558
Right Turn on Red				Yes		Yes
Satd. Flow (RTOR)				213		25
Link Speed (mph)		45	45		35	
Link Distance (ft)		475	550		970	
Travel Time (s)		7.2	8.3		18.9	
Peak Hour Factor	0.95	0.95	0.95	0.95	0.95	0.95
Heavy Vehicles (%)	1%	2%	1%	1%	1%	1%
Adj. Flow (vph)	322	888	949	609	906	435
Shared Lane Traffic (%)						
Lane Group Flow (vph)	322	888	949	609	906	435
Number of Detectors	1	1	1	1	1	1
Detector Template						
Leading Detector (ft)	35	5	5	5	35	35
Trailing Detector (ft)	-5	0	0	0	-5	-5
Detector 1 Position(ft)	-5	0	0	0	-5	-5
Detector 1 Size(ft)	40	5	5	5	40	40
Detector 1 Type	CI+Ex	CI+Ex	CI+Ex	CI+Ex	CI+Ex	CI+Ex
Detector 1 Channel						
Detector 1 Extend (s)	0.0	0.0	0.0	0.0	0.0	0.0
Detector 1 Queue (s)	0.0	0.0	0.0	0.0	0.0	0.0
Detector 1 Delay (s)	0.0	0.0	0.0	0.0	0.0	0.0
Turn Type	pm+pt	NA	NA	pm+ov	Prot	pm+ov
Protected Phases	5	2	6	4	4	5
Permitted Phases	2			6		4
Detector Phase	5	2	6	4	4	5
Switch Phase						
Minimum Initial (s)	3.0	20.0	20.0	7.0	7.0	3.0
Minimum Split (s)	9.0	26.0	26.0	14.0	14.0	9.0
Total Split (s)	30.0	76.0	46.0	44.0	44.0	30.0
Total Split (%)	25.0%	63.3%	38.3%	36.7%	36.7%	25.0%
Maximum Green (s)	24.0	70.0	40.0	37.0	37.0	24.0
Yellow Time (s)	4.0	4.0	4.0	4.0	4.0	4.0
All-Red Time (s)	2.0	2.0	2.0	3.0	3.0	2.0
Lost Time Adjust (s)	-1.0	-1.0	-1.0	-1.0	-1.0	-1.0
Total Lost Time (s)	5.0	5.0	5.0	6.0	6.0	5.0

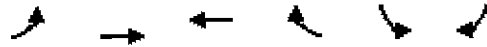

Lane Group	EBL	EBT	WBT	WBR	SBL	SBR
Lead/Lag	Lead		Lag		Lead	
Lead-Lag Optimize?						
Vehicle Extension (s)	3.0	3.0	3.0	3.0	3.0	3.0
Recall Mode	None	C-Max	C-Max	None	None	None
Act Effct Green (s)	71.6	71.6	44.3	86.6	37.4	65.7
Actuated g/C Ratio	0.60	0.60	0.37	0.72	0.31	0.55
v/c Ratio	0.85	0.46	0.79	0.55	0.89	0.50
Control Delay	33.9	17.7	37.3	6.5	51.4	17.7
Queue Delay	0.0	0.1	0.1	0.3	0.0	0.0
Total Delay	33.9	17.8	37.4	6.8	51.4	17.7
LOS	C	B	D	A	D	B
Approach Delay		22.1	25.5		40.5	
Approach LOS		C	C		D	
Queue Length 50th (ft)	170	283	304	131	341	177
Queue Length 95th (ft)	m211	m315	398	202	#450	261
Internal Link Dist (ft)		395	470		890	
Turn Bay Length (ft)	225			210		415
Base Capacity (vph)	410	1944	1201	1117	1034	898
Starvation Cap Reductn	0	0	12	132	0	0
Spillback Cap Reductn	0	212	0	0	0	25
Storage Cap Reductn	0	0	0	0	0	0
Reduced v/c Ratio	0.79	0.51	0.80	0.62	0.88	0.50

Intersection Summary

Area Type: Other
 Cycle Length: 120
 Actuated Cycle Length: 120
 Offset: 77 (64%), Referenced to phase 2:EBTL and 6:WBT, Start of 1st Green
 Natural Cycle: 80
 Control Type: Actuated-Coordinated
 Maximum v/c Ratio: 0.89
 Intersection Signal Delay: 29.4
 Intersection Capacity Utilization 83.5%
 Analysis Period (min) 15
 Intersection LOS: C
 ICU Level of Service E

95th percentile volume exceeds capacity, queue may be longer.
 Queue shown is maximum after two cycles.
 m Volume for 95th percentile queue is metered by upstream signal.

Splits and Phases: 2: Welsh Road & Dresher Road

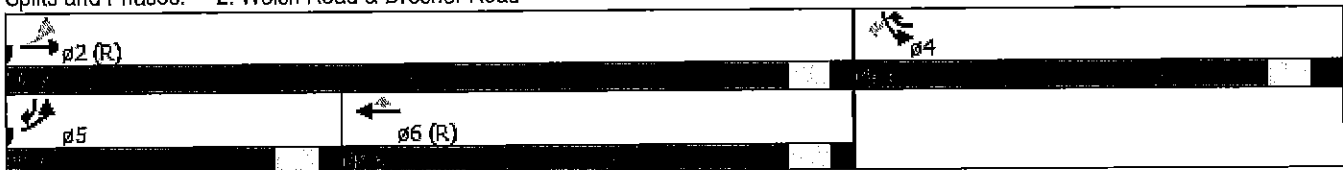

BT Dreshertown, LP
 3: Dreshertown Road & Welsh Road

2018 Without PM Peak



Lane Group	EBT	EBP	WBL	WBT	NBL	NBR
Lane Configurations	↑↑	↑	↓	↑↑	↓↓	↑
Volume (vph)	1126	579	468	1070	411	456
Ideal Flow (vphpl)	1800	1800	1800	1800	1800	1800
Lane Width (ft)	11	15	10	12	12	15
Grade (%)	-2%			1%	1%	
Storage Length (ft)		150	175		0	350
Storage Lanes		1	1		2	2
Taper Length (ft)			75		75	
Lane Util. Factor	0.95	1.00	1.00	0.95	0.97	1.00
Frt		0.850				0.850
Flt Protected			0.950		0.950	
Satd. Flow (prot)	3274	1683	1557	3369	3268	1626
Flt Permitted			0.075		0.950	
Satd. Flow (perm)	3274	1683	123	3369	3268	1626
Right Turn on Red		Yes				Yes
Satd. Flow (RTOR)		328				15
Link Speed (mph)	45			45	40	
Link Distance (ft)	550			1040	778	
Travel Time (s)	8.3			15.8	13.3	
Peak Hour Factor	0.96	0.96	0.96	0.96	0.96	0.96
Heavy Vehicles (%)	2%	1%	2%	1%	1%	3%
Adj. Flow (vph)	1173	603	488	1115	428	475
Shared Lane Traffic (%)						
Lane Group Flow (vph)	1173	603	488	1115	428	475
Number of Detectors	1	1	1	1	1	1
Detector Template						
Leading Detector (ft)	5	5	35	5	35	35
Trailing Detector (ft)	0	0	-5	0	-5	-5
Detector 1 Position(ft)	0	0	-5	0	-5	-5
Detector 1 Size(ft)	5	5	40	5	40	40
Detector 1 Type	Cl+Ex	Cl+Ex	Cl+Ex	Cl+Ex	Cl+Ex	Cl+Ex
Detector 1 Channel						
Detector 1 Extend (s)	0.0	0.0	0.0	0.0	0.0	0.0
Detector 1 Queue (s)	0.0	0.0	0.0	0.0	0.0	0.0
Detector 1 Delay (s)	0.0	0.0	0.0	0.0	0.0	0.0
Turn Type	NA	Perm	pm+pt	NA	Prot	pm+ov
Protected Phases	2		1	6	8	1
Permitted Phases		2	6			8
Detector Phase	2	2	1	6	8	1
Switch Phase						
Minimum Initial (s)	20.0	20.0	3.0	20.0	7.0	3.0
Minimum Split (s)	27.0	27.0	10.0	27.0	14.0	10.0
Total Split (s)	51.0	51.0	42.0	93.0	27.0	42.0
Total Split (%)	42.5%	42.5%	35.0%	77.5%	22.5%	35.0%
Maximum Green (s)	44.0	44.0	35.0	86.0	20.0	35.0
Yellow Time (s)	5.0	5.0	5.0	5.0	4.0	5.0
All-Red Time (s)	2.0	2.0	2.0	2.0	3.0	2.0
Lost Time Adjust (s)	-1.0	-1.0	-1.0	-1.0	-1.0	-1.0
Total Lost Time (s)	6.0	6.0	6.0	6.0	6.0	6.0

BT Dreshertown, LP
 3: Dreshertown Road & Welsh Road

2018 Without PM Peak

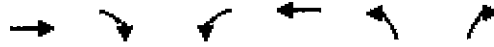

Lane Group	EBT	EBR	WBL	WBT	NBL	NBR
Lead/Lag	Lag	Lag	Lead			Lead
Lead-Lag Optimize?						
Vehicle Extension (s)	3.0	3.0	3.0	3.0	3.0	3.0
Recall Mode	C-Max	C-Max	None	C-Max	None	None

Intersection Summary

Area Type: Other
 Cycle Length: 120
 Actuated Cycle Length: 120
 Offset: 29 (24%), Referenced to phase 2:EBT and 6:WBTL, Start of 1st Green
 Natural Cycle: 80
 Control Type: Actuated-Coordinated

Splits and Phases: 3: Dreshertown Road & Welsh Road

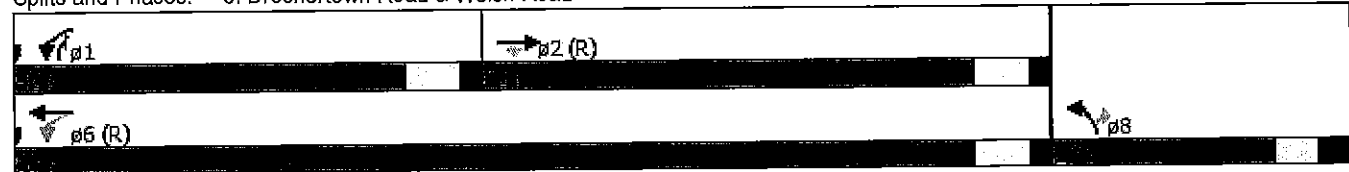

























Movement	EBT	EBR	WBL	WBT	NBL	NBR
Lane Configurations	↑↑	↑	↑	↑↑	↑↑	↑
Volume (veh/h)	1126	579	468	1070	411	456
Number	2	12	1	6	3	18
Initial Q (Qb), veh	0	0	0	0	0	0
Ped-Bike Adj(A_pbT)		1.00	1.00		1.00	1.00
Parking Bus, Adj	1.00	1.00	1.00	1.00	1.00	1.00
Adj Sat Flow, veh/h/ln	1782	1872	1756	1773	1773	1808
Adj Flow Rate, veh/h	1173	577	488	1115	428	429
Adj No. of Lanes	2	1	1	2	2	1
Peak Hour Factor	0.96	0.96	0.96	0.96	0.96	0.96
Percent Heavy Veh, %	2	1	2	1	1	3
Cap, veh/h	1418	666	514	2443	573	663
Arrive On Green	0.28	0.28	0.51	1.00	0.17	0.17
Sat Flow, veh/h	3476	1591	1672	3458	3276	1537
Grp Volume(v), veh/h	1173	577	488	1115	428	429
Grp Sat Flow(s),veh/h/ln	1693	1591	1672	1685	1638	1537
Q Serve(g_s), s	38.9	41.4	26.2	0.0	14.9	21.0
Cycle Q Clear(g_c), s	38.9	41.4	26.2	0.0	14.9	21.0
Prop In Lane		1.00	1.00		1.00	1.00
Lane Grp Cap(c), veh/h	1418	666	514	2443	573	663
V/C Ratio(X)	0.83	0.87	0.95	0.46	0.75	0.65
Avail Cap(c_a), veh/h	1418	666	587	2443	573	663
HCM Platoon Ratio	0.67	0.67	2.00	2.00	1.00	1.00
Upstream Filter(l)	0.68	0.68	0.81	0.81	1.00	1.00
Uniform Delay (d), s/veh	39.1	40.0	19.1	0.0	47.0	26.9
Incr Delay (d2), s/veh	3.9	10.2	20.5	0.5	5.3	2.2
Initial Q Delay(d3),s/veh	0.0	0.0	0.0	0.0	0.0	0.0
%ile BackOfQ(95%),veh/ln	24.9	26.1	23.7	0.3	11.5	17.2
LnGrp Delay(d),s/veh	43.0	50.1	39.7	0.5	52.3	29.1
LnGrp LOS	D	D	D	A	D	C
Approach Vol, veh/h	1750			1603	857	
Approach Delay, s/veh	45.4			12.4	40.7	
Approach LOS	D			B	D	

Timer	1	2	3	4	5	6	7	8
Assigned Phs	1	2				6		8
Phs Duration (G+Y+Rc), s	36.7	56.3				93.0		27.0
Change Period (Y+Rc), s	7.0	7.0				7.0		7.0
Max Green Setting (Gmax), s	35.0	44.0				86.0		20.0
Max Q Clear Time (g_c+1), s	28.7	43.9				2.5		23.5
Green Ext Time (p_c), s	1.0	0.1				16.2		0.0

Intersection Summary	
HCM 2010 Ctrl Delay	31.9
HCM 2010 LOS	C

BT Dreshertown, LP
4: Dryden Road & Welsh Road

2018 Without PM Peak

												
Lane Group	EBL	EBT	EBR	WBL	WBT	WBR	NBL	NBT	NBR	SEL	SBT	GBR
Lane Configurations												
Volume (vph)	0	1613	5	0	1437	0	95	8	9	3	0	1
Ideal Flow (vphpl)	1800	1800	1800	1800	1800	1800	1800	1800	1800	1800	1800	1800
Lane Width (ft)	10	12	14	10	12	12	11	15	15	12	14	14
Grade (%)		-1%			-1%			-1%			0%	
Storage Length (ft)	150		225	175		0	110		0	150		0
Storage Lanes	1		1	1		0	1		0	1		0
Taper Length (ft)	75			75			75			75		
Lane Util. Factor	1.00	0.95	1.00	1.00	0.95	0.95	1.00	1.00	1.00	1.00	1.00	1.00
Frt			0.850					0.921			0.850	
Flt Protected							0.950			0.950		
Satd. Flow (prof)	1688	3403	1640	1688	3370	0	1661	1833	0	1710	1632	0
Flt Permitted							0.757			0.746		
Satd. Flow (perm)	1688	3403	1640	1688	3370	0	1324	1833	0	1343	1632	0
Right Turn on Red			Yes			Yes			Yes			Yes
Satd. Flow (RTOR)			27					9			79	
Link Speed (mph)		45			45			25			25	
Link Distance (ft)		1040			1416			754			960	
Travel Time (s)		15.8			21.5			20.6			26.2	
Peak Hour Factor	0.97	0.97	0.97	0.97	0.97	0.97	0.97	0.97	0.97	0.97	0.97	0.97
Heavy Vehicles (%)	0%	1%	0%	0%	2%	0%	0%	0%	0%	0%	0%	0%
Adj. Flow (vph)	0	1663	5	0	1481	0	98	8	9	3	0	1
Shared Lane Traffic (%)												
Lane Group Flow (vph)	0	1663	5	0	1481	0	98	17	0	3	1	0
Number of Detectors	1	1	1	1	1		1	1		1	1	
Detector Template												
Leading Detector (ft)	5	5	5	5	5		35	35		35	35	
Trailing Detector (ft)	0	0	0	0	0		-5	-5		-5	-5	
Detector 1 Position(ft)	0	0	0	0	0		-5	-5		-5	-5	
Detector 1 Size(ft)	5	5	5	5	5		40	40		40	40	
Detector 1 Type	CI+Ex	CI+Ex	CI+Ex	CI+Ex	CI+Ex		CI+Ex	CI+Ex		CI+Ex	CI+Ex	
Detector 1 Channel												
Detector 1 Extend (s)	0.0	0.0	0.0	0.0	0.0		0.0	0.0		0.0	0.0	
Detector 1 Queue (s)	0.0	0.0	0.0	0.0	0.0		0.0	0.0		0.0	0.0	
Detector 1 Delay (s)	0.0	0.0	0.0	0.0	0.0		0.0	0.0		0.0	0.0	
Turn Type	Perm	NA	Perm	Perm	NA		Perm	NA		Perm	NA	
Protected Phases		2			6			8				4
Permitted Phases	2		2	6			8			4		
Detector Phase	2	2	2	6	6		8	8		4	4	
Switch Phase												
Minimum Initial (s)	21.0	21.0	21.0	21.0	21.0		5.0	5.0		5.0	5.0	
Minimum Split (s)	27.0	27.0	27.0	27.0	27.0		11.0	11.0		11.0	11.0	
Total Split (s)	95.0	95.0	95.0	95.0	95.0		25.0	25.0		25.0	25.0	
Total Split (%)	79.2%	79.2%	79.2%	79.2%	79.2%		20.8%	20.8%		20.8%	20.8%	
Maximum Green (s)	89.0	89.0	89.0	89.0	89.0		19.0	19.0		19.0	19.0	
Yellow Time (s)	4.0	4.0	4.0	4.0	4.0		3.0	3.0		3.0	3.0	
All-Red Time (s)	2.0	2.0	2.0	2.0	2.0		3.0	3.0		3.0	3.0	
Lost Time Adjust (s)	-1.0	-1.0	-1.0	-1.0	-1.0		-1.0	-1.0		-1.0	-1.0	
Total Lost Time (s)	5.0	5.0	5.0	5.0	5.0		5.0	5.0		5.0	5.0	

BT Dreshertown, LP
 4: Dryden Road & Welsh Road

2018 Without PM Peak



Lane Group	EBL	EBT	EBR	WBL	WBT	WBR	NBL	NBT	NBR	SBL	SBT	SBR
Lead/Lag												
Lead-Lag Optimize?												
Vehicle Extension (s)	3.0	3.0	3.0	3.0	3.0		3.0	3.0		3.0	3.0	
Recall Mode	C-Max	C-Max	C-Max	C-Max	C-Max		None	None		None	None	

Intersection Summary
 Area Type: Other
 Cycle Length: 120
 Actuated Cycle Length: 120
 Offset: 59 (49%), Referenced to phase 2:EBTL and 6:WBTL, Start of 1st Green
 Natural Cycle: 50
 Control Type: Actuated-Coordinated

Splits and Phases: 4: Dryden Road & Welsh Road

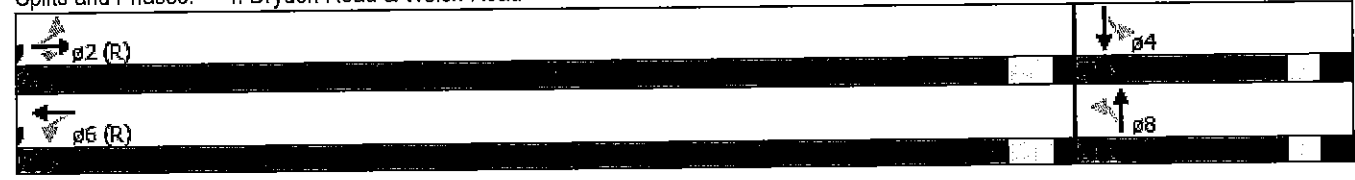

Movement	EBL	EBT	EBR	WBL	WBT	WBR	NBL	NBT	NBR	SBL	SBT	SBR
Lane Configurations	↖	↗	↘	↖	↗		↖	↗		↖	↗	
Volume (veh/h)	0	1613	5	0	1437	0	95	8	9	3	0	1
Number	5	2	12	1	6	16	3	8	18	7	4	14
Initial Q (Qb), veh	0	0	0	0	0	0	0	0	0	0	0	0
Ped-Bike Adj(A_pbT)	1.00		1.00	1.00		1.00	1.00		1.00	1.00		1.00
Parking Bus, Adj	1.00	1.00	1.00	1.00	1.00	1.00	1.00	1.00	1.00	1.00	1.00	1.00
Adj Sat Flow, veh/h/ln	1809	1791	1881	1809	1774	1809	1809	1881	1881	1800	1872	1872
Adj Flow Rate, veh/h	0	1663	3	0	1481	0	98	8	9	3	0	1
Adj No. of Lanes	1	2	1	1	2	0	1	1	0	1	1	0
Peak Hour Factor	0.97	0.97	0.97	0.97	0.97	0.97	0.97	0.97	0.97	0.97	0.97	0.97
Percent Heavy Veh, %	0	1	0	0	2	2	0	0	0	0	0	0
Cap, veh/h	60	2797	1314	60	2769	0	197	77	86	188	0	151
Arrive On Green	0.00	1.00	1.00	0.00	0.82	0.00	0.09	0.09	0.09	0.09	0.00	0.09
Sat Flow, veh/h	364	3403	1599	304	3458	0	1446	810	911	1418	0	1591
Grp Volume(v), veh/h	0	1663	3	0	1481	0	98	0	17	3	0	1
Grp Sat Flow(s), veh/h/ln	364	1702	1599	304	1685	0	1446	0	1721	1418	0	1591
Q Serve(g_s), s	0.0	0.0	0.0	0.0	16.8	0.0	7.9	0.0	1.1	0.2	0.0	0.1
Cycle Q Clear(g_c), s	0.0	0.0	0.0	0.0	16.8	0.0	7.9	0.0	1.1	0.8	0.0	0.1
Prop In Lane	1.00		1.00	1.00		0.00	1.00		0.53	1.00		1.00
Lane Grp Cap(c), veh/h	60	2797	1314	60	2769	0	197	0	163	188	0	151
V/C Ratio(X)	0.00	0.59	0.00	0.00	0.53	0.00	0.50	0.00	0.10	0.02	0.00	0.01
Avail Cap(c_a), veh/h	60	2797	1314	60	2769	0	301	0	287	289	0	265
HCM Platoon Ratio	2.00	2.00	2.00	1.00	1.00	1.00	1.00	1.00	1.00	1.00	1.00	1.00
Upstream Filter(I)	0.00	0.47	0.47	0.00	1.00	0.00	1.00	0.00	1.00	1.00	0.00	1.00
Uniform Delay (d), s/veh	0.0	0.0	0.0	0.0	3.4	0.0	52.7	0.0	49.9	49.8	0.0	49.6
Incr Delay (d2), s/veh	0.0	0.4	0.0	0.0	0.7	0.0	1.9	0.0	0.3	0.0	0.0	0.0
Initial Q Delay(d3),s/veh	0.0	0.0	0.0	0.0	0.0	0.0	0.0	0.0	0.0	0.0	0.0	0.0
%ile BackOfQ(95%),veh/ln	0.0	0.3	0.0	0.0	12.5	0.0	5.9	0.0	1.0	0.2	0.0	0.1
LnGrp Delay(d),s/veh	0.0	0.4	0.0	0.0	4.1	0.0	54.7	0.0	50.2	49.8	0.0	49.7
LnGrp LOS		A	A		A		D		D	D		D
Approach Vol, veh/h		1666			1481			115				4
Approach Delay, s/veh		0.4			4.1			54.0				49.8
Approach LOS		A			A			D				D
Phs	1	2	3	4	5	6	7	8				
Assigned Phs		2		4		6		8				
Phs Duration (G+Y+Rc), s		103.6		16.4		103.6		16.4				
Change Period (Y+Rc), s		6.0		6.0		6.0		6.0				
Max Green Setting (Gmax), s		89.0		19.0		89.0		19.0				
Max Q Clear Time (g_c+l1), s		2.5		3.3		19.3		10.4				
Green Ext Time (p_c), s		22.2		0.3		21.6		0.2				
Intersection Summary												
HCM 2010 Ctrl Delay			4.1									
HCM 2010 LOS			A									

1: Jarrettown Road/Village Road & Welsh Road



Lane Group	EBL	EBT	EBR	WBL	WBT	WBR	NBL	NBT	NBR	SBL	SBT	SBR
Lane Configurations	↖	↗		↖	↗		↖	↗	↖	↗	↕	
Volume (vph)	10	603	19	134	563	8	7	2	185	12	2	7
Ideal Flow (vphpl)	1800	1800	1800	1800	1800	1800	1800	1800	1800	1800	1800	1800
Lane Width (ft)	12	12	12	11	14	14	12	12	14	15	15	15
Grade (%)		-6%			1%			-1%			1%	
Storage Length (ft)	150		0	100		0	0		175	0		0
Storage Lanes	1		0	1		0	0		1	0		0
Taper Length (ft)	75			75			75			75		
Lane Util. Factor	1.00	1.00	1.00	1.00	1.00	1.00	1.00	1.00	1.00	1.00	1.00	1.00
Frt		0.995			0.998				0.850		0.953	
Flt Protected	0.950			0.950				0.962			0.973	
Satd. Flow (prot)	1761	1813	0	1612	1907	0	0	1740	1640	0	1827	0
Flt Permitted	0.427			0.310				0.857			0.819	
Satd. Flow (perm)	792	1813	0	526	1907	0	0	1550	1640	0	1538	0
Right Turn on Red			Yes			Yes			Yes			Yes
Satd. Flow (RTOR)		3			2				203		8	
Link Speed (mph)		45			45			35			35	
Link Distance (ft)		1263			605			421			431	
Travel Time (s)		19.1			9.2			8.2			8.4	
Peak Hour Factor	0.91	0.91	0.91	0.91	0.91	0.91	0.91	0.91	0.91	0.91	0.91	0.91
Heavy Vehicles (%)	0%	1%	25%	2%	0%	0%	0%	0%	0%	0%	0%	0%
Adj. Flow (vph)	11	663	21	147	619	9	8	2	203	13	2	8
Shared Lane Traffic (%)												
Lane Group Flow (vph)	11	684	0	147	628	0	0	10	203	0	23	0
Number of Detectors	1	2		1	2		1	1	1	1	1	
Detector Template	Left			Left			Left	Thru	Right	Left	Thru	
Leading Detector (ft)	5	330		35	330		20	35	35	20	35	
Trailing Detector (ft)	0	0		-5	0		0	-5	-5	0	-5	
Detector 1 Position(ft)	0	0		-5	0		0	-5	-5	0	-5	
Detector 1 Size(ft)	5	6		40	6		20	40	40	20	40	
Detector 1 Type	CI+Ex	CI+Ex		CI+Ex	CI+Ex		CI+Ex	CI+Ex	CI+Ex	CI+Ex	CI+Ex	
Detector 1 Channel												
Detector 1 Extend (s)	0.0	0.0		0.0	0.0		0.0	0.0	0.0	0.0	0.0	
Detector 1 Queue (s)	0.0	0.0		0.0	0.0		0.0	0.0	0.0	0.0	0.0	
Detector 1 Delay (s)	0.0	0.0		0.0	0.0		0.0	0.0	0.0	0.0	0.0	
Detector 2 Position(ft)		324			324							
Detector 2 Size(ft)		6			6							
Detector 2 Type		CI+Ex			CI+Ex							
Detector 2 Channel												
Detector 2 Extend (s)		0.0			0.0							
Turn Type	Perm	NA		pm+pt	NA		Perm	NA	pm+ov	Perm	NA	
Protected Phases		2		1	6			8	1		4	
Permitted Phases	2			6			8		8	4		
Detector Phase	2	2		1	6		8	8	1	4	4	
Switch Phase												
Minimum Initial (s)	15.0	15.0		3.0	15.0		7.0	7.0	3.0	7.0	7.0	
Minimum Split (s)	22.0	22.0		10.0	22.0		13.0	13.0	10.0	13.0	13.0	
Total Split (s)	63.0	63.0		19.0	82.0		18.0	18.0	19.0	18.0	18.0	
Total Split (%)	63.0%	63.0%		19.0%	82.0%		18.0%	18.0%	19.0%	18.0%	18.0%	

1: Jarrettown Road/Village Road & Welsh Road



Lane Group	EBL	EBT	EBR	WBL	WBT	WBR	NBL	NBT	NBR	SBL	SBT	SBR
Maximum Green (s)	56.0	56.0		12.0	75.0		12.0	12.0	12.0	12.0	12.0	12.0
Yellow Time (s)	5.0	5.0		5.0	5.0		4.0	4.0	5.0	4.0	4.0	4.0
All-Red Time (s)	2.0	2.0		2.0	2.0		2.0	2.0	2.0	2.0	2.0	2.0
Lost Time Adjust (s)	-1.0	-1.0		-1.0	-1.0			-1.0	-1.0			-1.0
Total Lost Time (s)	6.0	6.0		6.0	6.0			5.0	6.0			5.0
Lead/Lag	Lag	Lag		Lead					Lead			
Lead-Lag Optimize?												
Vehicle Extension (s)	3.0	3.0		3.0	3.0		3.0	3.0	3.0	3.0	3.0	3.0
Recall Mode	C-Max	C-Max		None	C-Max		None	None	None	None	None	None

Intersection Summary

Area Type: Other
 Cycle Length: 100
 Actuated Cycle Length: 100
 Offset: 26 (26%), Referenced to phase 2:EBTL and 6:WBTL, Start of 1st Green
 Natural Cycle: 60
 Control Type: Actuated-Coordinated

Splits and Phases: 1: Jarrettown Road/Village Road & Welsh Road

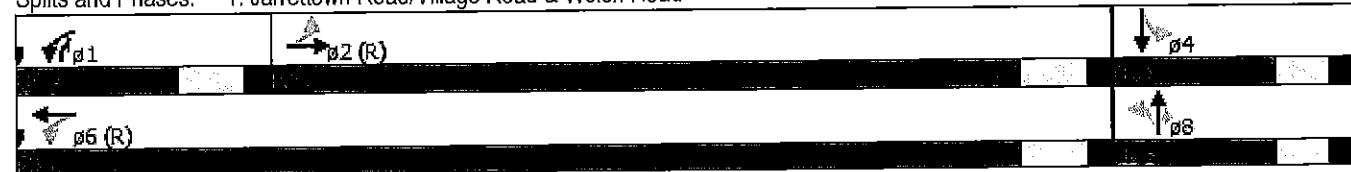

1: Jarrettown Road/Village Road & Welsh Road

Movement	EBL	EBT	EBR	WBL	WBT	WBR	NBL	NBT	NBR	SBL	SBT	SBR
Lane Configurations												
Volume (veh/h)	10	603	19	134	563	8	7	2	185	12	2	7
Number	5	2	12	1	6	16	3	8	18	7	4	14
Initial Q (Qb), veh	0	0	0	0	0	0	0	0	0	0	0	0
Ped-Bike Adj(A_pbT)	1.00		1.00	1.00		1.00	1.00		1.00	1.00		1.00
Parking Bus, Adj	1.00	1.00	1.00	1.00	1.00	1.00	1.00	1.00	1.00	1.00	1.00	1.00
Adj Sat Flow, veh/h/ln	1854	1822	1854	1756	1863	1863	1809	1809	1881	1863	1863	1863
Adj Flow Rate, veh/h	11	663	20	147	619	9	8	2	105	13	2	3
Adj No. of Lanes	1	1	0	1	1	0	0	1	1	0	1	0
Peak Hour Factor	0.91	0.91	0.91	0.91	0.91	0.91	0.91	0.91	0.91	0.91	0.91	0.91
Percent Heavy Veh, %	0	1	1	2	0	0	0	0	0	0	0	0
Cap, veh/h	637	1192	36	537	1458	21	172	37	244	150	26	23
Arrive On Green	0.68	0.68	0.67	0.06	0.80	0.79	0.08	0.09	0.09	0.08	0.09	0.08
Sat Flow, veh/h	835	1760	53	1672	1831	27	1140	393	1599	939	283	244
Grp Volume(v), veh/h	11	0	683	147	0	628	10	0	105	18	0	0
Grp Sat Flow(s),veh/h/ln	835	0	1813	1672	0	1858	1533	0	1599	1466	0	0
Q Serve(g_s), s	0.4	0.0	19.5	2.3	0.0	10.4	0.0	0.0	6.0	0.2	0.0	0.0
Cycle Q Clear(g_c), s	0.4	0.0	19.5	2.3	0.0	10.4	0.5	0.0	6.0	1.0	0.0	0.0
Prop In Lane	1.00		0.03	1.00		0.01	0.80		1.00	0.72		0.17
Lane Grp Cap(c), veh/h	637	0	1228	537	0	1480	193	0	244	185	0	0
V/C Ratio(X)	0.02	0.00	0.56	0.27	0.00	0.42	0.05	0.00	0.43	0.10	0.00	0.00
Avail Cap(c_a), veh/h	637	0	1228	655	0	1480	248	0	303	237	0	0
HCM Platoon Ratio	1.00	1.00	1.00	1.00	1.00	1.00	1.00	1.00	1.00	1.00	1.00	1.00
Upstream Filter(I)	1.00	0.00	1.00	1.00	0.00	1.00	1.00	0.00	1.00	1.00	0.00	0.00
Uniform Delay (d), s/veh	5.3	0.0	8.4	6.0	0.0	3.1	41.7	0.0	38.4	41.9	0.0	0.0
Incr Delay (d2), s/veh	0.0	0.0	1.8	0.3	0.0	0.9	0.1	0.0	1.2	0.2	0.0	0.0
Initial Q Delay(d3),s/veh	0.0	0.0	0.0	0.0	0.0	0.0	0.0	0.0	0.0	0.0	0.0	0.0
%ile BackOfQ(95%),veh/ln	0.2	0.0	15.6	2.0	0.0	9.5	0.5	0.0	4.9	0.9	0.0	0.0
LnGrp Delay(d),s/veh	5.3	0.0	10.2	6.3	0.0	4.0	41.8	0.0	39.6	42.1	0.0	0.0
LnGrp LOS	A		B	A		A	D		D	D		
Approach Vol, veh/h		694			775			115			18	
Approach Delay, s/veh		10.1			4.5			39.8			42.1	
Approach LOS		B			A			D			D	
Timer	1	2	3	4	5	6	7	8				
Assigned Phs	1	2		4		6		8				
Phs Duration (G+Y+Rc), s	11.9	73.7		14.4		85.6		14.4				
Change Period (Y+Rc), s	7.0	7.0		6.0		7.0		6.0				
Max Green Setting (Gmax), s	12.0	56.0		12.0		75.0		12.0				
Max Q Clear Time (g_c+I1), s	4.8	21.5		3.0		12.4		8.5				
Green Ext Time (p_c), s	0.2	26.5		0.3		40.9		0.1				
Intersection Summary												
HCM 2010 Ctrl Delay			9.9									
HCM 2010 LOS			A									

BT Dreshertown, LP
2: Welsh Road & Dresher Road

2018 Without SAT Peak

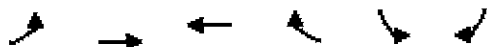

Lane Group	EBL	EBT	WBT	WBR	SBL	SBR
Lane Configurations	↖	↕	↕	↗	↖	↗
Volume (vph)	150	682	598	382	346	144
Ideal Flow (vphpl)	1800	1800	1800	1800	1800	1800
Lane Width (ft)	10	11	11	11	12	13
Grade (%)		-1%	1%		1%	
Storage Length (ft)	225			210	0	415
Storage Lanes	1			1	2	1
Taper Length (ft)	75				75	
Lane Util. Factor	1.00	0.95	0.95	1.00	0.97	1.00
Friction				0.850		0.850
Flt Protected	0.950				0.950	
Satd. Flow (prot)	1573	3290	3257	1472	3301	1542
Flt Permitted	0.337				0.950	
Satd. Flow (perm)	558	3290	3257	1472	3301	1542
Right Turn on Red				Yes		Yes
Satd. Flow (RTOR)				411		131
Link Speed (mph)		45	45		35	
Link Distance (ft)		475	550		970	
Travel Time (s)		7.2	8.3		18.9	
Peak Hour Factor	0.93	0.93	0.93	0.93	0.93	0.93
Heavy Vehicles (%)	2%	1%	1%	0%	0%	2%
Adj. Flow (vph)	161	733	643	411	372	155
Shared Lane Traffic (%)						
Lane Group Flow (vph)	161	733	643	411	372	155
Number of Detectors	1	1	1	1	1	1
Detector Template						
Leading Detector (ft)	35	5	5	5	35	35
Trailing Detector (ft)	-5	0	0	0	-5	-5
Detector 1 Position(ft)	-5	0	0	0	-5	-5
Detector 1 Size(ft)	40	5	5	5	40	40
Detector 1 Type	CI+Ex	CI+Ex	CI+Ex	CI+Ex	CI+Ex	CI+Ex
Detector 1 Channel						
Detector 1 Extend (s)	0.0	0.0	0.0	0.0	0.0	0.0
Detector 1 Queue (s)	0.0	0.0	0.0	0.0	0.0	0.0
Detector 1 Delay (s)	0.0	0.0	0.0	0.0	0.0	0.0
Turn Type	pm+pt	NA	NA	pm+ov	Prot	pm+ov
Protected Phases	5	2	6	4	4	5
Permitted Phases	2			6		4
Detector Phase	5	2	6	4	4	5
Switch Phase						
Minimum Initial (s)	3.0	20.0	20.0	7.0	7.0	3.0
Minimum Split (s)	9.0	26.0	26.0	14.0	14.0	9.0
Total Split (s)	23.0	68.0	45.0	32.0	32.0	23.0
Total Split (%)	23.0%	68.0%	45.0%	32.0%	32.0%	23.0%
Maximum Green (s)	17.0	62.0	39.0	25.0	25.0	17.0
Yellow Time (s)	4.0	4.0	4.0	4.0	4.0	4.0
All-Red Time (s)	2.0	2.0	2.0	3.0	3.0	2.0
Lost Time Adjust (s)	-1.0	-1.0	-1.0	-1.0	-1.0	-1.0
Total Lost Time (s)	5.0	5.0	5.0	6.0	6.0	5.0

BT Dreshertown, LP
 2: Welsh Road & Dresher Road

2018 Without SAT Peak

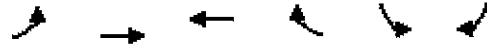

Lane Group	EBL	EBT	WBT	WBR	SBL	SBR
Lead/Lag	Lead		Lag		Lead	
Lead-Lag Optimize?						
Vehicle Extension (s)	3.0	3.0	3.0	3.0	3.0	3.0
Recall Mode	None	C-Max	C-Max	None	None	None
Act Effct Green (s)	70.4	70.4	55.2	78.8	18.6	34.8
Actuated g/C Ratio	0.70	0.70	0.55	0.79	0.19	0.35
v/c Ratio	0.32	0.32	0.36	0.33	0.61	0.25
Control Delay	6.5	5.5	14.2	2.5	41.2	6.0
Queue Delay	0.0	0.0	0.0	0.0	0.0	0.0
Total Delay	6.5	5.5	14.2	2.5	41.2	6.0
LOS	A	A	B	A	D	A
Approach Delay		5.6	9.6		30.8	
Approach LOS		A	A		C	
Queue Length 50th (ft)	26	65	137	39	113	10
Queue Length 95th (ft)	51	100	158	72	150	46
Internal Link Dist (ft)		395	470		890	
Turn Bay Length (ft)	225			210		415
Base Capacity (vph)	575	2315	1796	1325	858	732
Starvation Cap Reductn	0	0	0	0	0	0
Spillback Cap Reductn	0	0	0	0	0	0
Storage Cap Reductn	0	0	0	0	0	0
Reduced v/c Ratio	0.28	0.32	0.36	0.31	0.43	0.21

Intersection Summary

Area Type: Other
 Cycle Length: 100
 Actuated Cycle Length: 100
 Offset: 38 (38%), Referenced to phase 2:EBTL and 6:WBT, Start of 1st Green
 Natural Cycle: 50
 Control Type: Actuated-Coordinated
 Maximum v/c Ratio: 0.61
 Intersection Signal Delay: 12.7
 Intersection Capacity Utilization 50.0%
 Analysis Period (min) 15

Intersection LOS: B
 ICU Level of Service A

Splits and Phases: 2: Welsh Road & Dresher Road

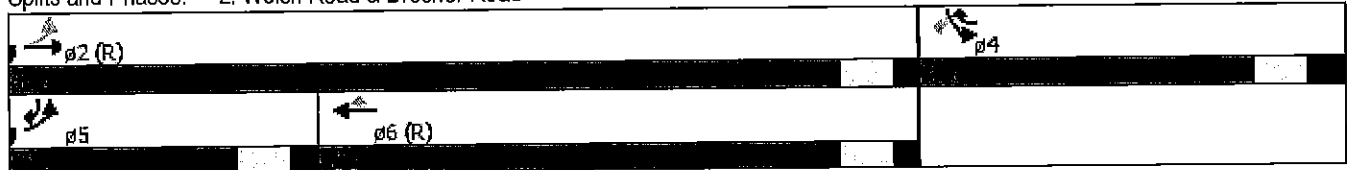

BT Dreshertown, LP
3: Dreshertown Road & Welsh Road

2018 Without SAT Peak

	→	↘	↙	←	↗	↖
Lane Group	EBT	EBR	WBL	WBT	NBL	NBR
Lane Configurations	↑↑	↑	↓	↑↑	↑↑	↑
Volume (vph)	854	174	254	809	172	302
Ideal Flow (vphpl)	1800	1800	1800	1800	1800	1800
Lane Width (ft)	11	15	10	12	12	15
Grade (%)	-2%			1%	1%	
Storage Length (ft)		150	175		0	350
Storage Lanes		1	1		2	2
Taper Length (ft)			75		75	
Lane Util. Factor	0.95	1.00	1.00	0.95	0.97	1.00
Frt		0.850				0.850
Flt Protected			0.950		0.950	
Satd. Flow (prot)	3339	1683	1588	3403	3301	1675
Flt Permitted			0.228		0.950	
Satd. Flow (perm)	3339	1683	381	3403	3301	1675
Right Turn on Red		Yes				Yes
Satd. Flow (RTOR)		184				76
Link Speed (mph)	45			45	40	
Link Distance (ft)	550			1040	778	
Travel Time (s)	8.3			15.8	13.3	
Peak Hour Factor	0.91	0.91	0.91	0.91	0.91	0.91
Heavy Vehicles (%)	0%	1%	0%	0%	0%	0%
Adj. Flow (vph)	938	191	279	889	189	332
Shared Lane Traffic (%)						
Lane Group Flow (vph)	938	191	279	889	189	332
Number of Detectors	1	1	1	1	1	1
Detector Template						
Leading Detector (ft)	5	5	35	5	35	35
Trailing Detector (ft)	0	0	-5	0	-5	-5
Detector 1 Position(ft)	0	0	-5	0	-5	-5
Detector 1 Size(ft)	5	5	40	5	40	40
Detector 1 Type	CI+Ex	CI+Ex	CI+Ex	CI+Ex	CI+Ex	CI+Ex
Detector 1 Channel						
Detector 1 Extend (s)	0.0	0.0	0.0	0.0	0.0	0.0
Detector 1 Queue (s)	0.0	0.0	0.0	0.0	0.0	0.0
Detector 1 Delay (s)	0.0	0.0	0.0	0.0	0.0	0.0
Turn Type	NA	Perm	pm+pt	NA	Prot	pm+ov
Protected Phases	2		1	6	8	1
Permitted Phases		2	6			8
Detector Phase	2	2	1	6	8	1
Switch Phase						
Minimum Initial (s)	20.0	20.0	3.0	20.0	7.0	3.0
Minimum Split (s)	27.0	27.0	10.0	27.0	14.0	10.0
Total Split (s)	53.0	53.0	29.0	82.0	18.0	29.0
Total Split (%)	53.0%	53.0%	29.0%	82.0%	18.0%	29.0%
Maximum Green (s)	46.0	46.0	22.0	75.0	11.0	22.0
Yellow Time (s)	5.0	5.0	5.0	5.0	4.0	5.0
All-Red Time (s)	2.0	2.0	2.0	2.0	3.0	2.0
Lost Time Adjust (s)	-1.0	-1.0	-1.0	-1.0	-1.0	-1.0
Total Lost Time (s)	6.0	6.0	6.0	6.0	6.0	6.0

BT Dreshertown, LP
 3: Dreshertown Road & Welsh Road

2018 Without SAT Peak



Lane Group	EBT	EBR	WBL	WBT	NBL	NBR
Lead/Lag	Lag	Lag	Lead			Lead
Lead-Lag Optimize?						
Vehicle Extension (s)	3.0	3.0	3.0	3.0	3.0	3.0
Recall Mode	C-Max	C-Max	None	C-Max	None	None

Intersection Summary

Area Type: Other
 Cycle Length: 100
 Actuated Cycle Length: 100
 Offset: 28 (28%), Referenced to phase 2:EBT and 6:WBTL, Start of 1st Green
 Natural Cycle: 60
 Control Type: Actuated-Coordinated

Splits and Phases: 3: Dreshertown Road & Welsh Road

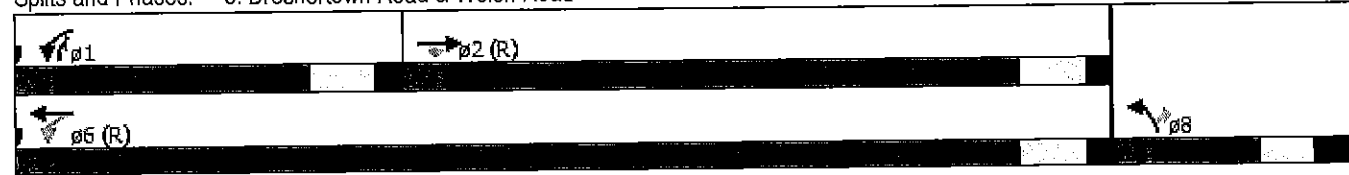

BT Dreshertown, LP
 3: Dreshertown Road & Welsh Road

2018 Without SAT Peak

	→	↘	↙	←	↗	↖		
Movement	EBT	EBR	WBL	WBT	NEB	NEP		
Lane Configurations	↑↑	↑	↓	↑↑	↑↑	↑		
Volume (veh/h)	854	174	254	809	172	302		
Number	2	12	1	6	3	18		
Initial Q (Qb), veh	0	0	0	0	0	0		
Ped-Bike Adj(A_pbT)		1.00	1.00		1.00	1.00		
Parking Bus, Adj	1.00	1.00	1.00	1.00	1.00	1.00		
Adj Sat Flow, veh/h/ln	1818	1872	1791	1791	1791	1863		
Adj Flow Rate, veh/h	938	191	279	889	189	246		
Adj No. of Lanes	2	1	1	2	2	1		
Peak Hour Factor	0.91	0.91	0.91	0.91	0.91	0.91		
Percent Heavy Veh, %	0	1	0	0	0	0		
Cap, veh/h	2067	952	547	2586	397	351		
Arrive On Green	1.00	1.00	0.20	1.00	0.12	0.12		
Sat Flow, veh/h	3545	1591	1706	3492	3309	1583		
Grp Volume(v), veh/h	938	191	279	889	189	246		
Grp Sat Flow(s),veh/h/ln	1727	1591	1706	1701	1655	1583		
Q Serve(g_s), s	0.0	0.0	5.9	0.0	5.3	12.0		
Cycle Q Clear(g_c), s	0.0	0.0	5.9	0.0	5.3	12.0		
Prop In Lane		1.00	1.00		1.00	1.00		
Lane Grp Cap(c), veh/h	2067	952	547	2586	397	351		
V/C Ratio(X)	0.45	0.20	0.51	0.34	0.48	0.70		
Avail Cap(c_a), veh/h	2067	952	766	2586	397	351		
HCM Platoon Ratio	2.00	2.00	2.00	2.00	1.00	1.00		
Upstream Filter(I)	0.91	0.91	0.94	0.94	1.00	1.00		
Uniform Delay (d), s/veh	0.0	0.0	4.1	0.0	41.1	35.9		
Incr Delay (d2), s/veh	0.7	0.4	0.7	0.3	0.9	6.1		
Initial Q Delay(d3),s/veh	0.0	0.0	0.0	0.0	0.0	0.0		
%ile BackOfQ(95%),veh/ln	0.3	0.2	4.9	0.2	4.5	11.2		
LnGrp Delay(d),s/veh	0.7	0.4	4.8	0.3	42.0	42.0		
LnGrp LOS	A	A	A	A	D	D		
Approach Vol, veh/h	1129			1168	435			
Approach Delay, s/veh	0.6			1.4	42.0			
Approach LOS	A			A	D			
Phase	1	2	3	4	5	6	7	8
Assigned Phs	1	2				6		8
Phs Duration (G+Y+Rc), s	16.2	65.8				82.0		18.0
Change Period (Y+Rc), s	7.0	7.0				7.0		7.0
Max Green Setting (Gmax), s	22.0	46.0				75.0		11.0
Max Q Clear Time (g_c+I1), s	8.4	2.5				2.5		14.5
Green Ext Time (p_c), s	0.7	8.0				8.1		0.0
Intersection Summary								
HCM 2010 Ctrl Delay			7.5					
HCM 2010 LOS			A					

4: Dryden Road & Welsh Road

Lane Group	EPL	EBT	EBR	WBL	WBT	WBR	NBL	NBT	NBR	SBL	SET	SBR
Lane Configurations												
Volume (vph)	2	1095	3	1	1074	2	1	0	1	2	0	2
Ideal Flow (vphpl)	1800	1800	1800	1800	1800	1800	1800	1800	1800	1800	1800	1800
Lane Width (ft)	10	12	14	10	12	12	11	15	15	12	14	14
Grade (%)		-1%			-1%			-1%			0%	
Storage Length (ft)	150		225	175		0	110		0	150		0
Storage Lanes	1		1	1		0	1		0	1		0
Taper Length (ft)	75			75			75			75		
Lane Util. Factor	1.00	0.95	1.00	1.00	0.95	0.95	1.00	1.00	1.00	1.00	1.00	1.00
Frnt			0.850					0.850			0.850	
Flt Protected	0.950			0.950			0.950			0.950		
Satd. Flow (prot)	1604	3437	1640	1604	3437	0	1661	1691	0	1710	1632	0
Flt Permitted	0.232			0.226								
Satd. Flow (perm)	392	3437	1640	382	3437	0	1749	1691	0	1800	1632	0
Right Turn on Red			Yes			Yes			Yes			Yes
Satd. Flow (RTOR)			33		1			147			153	
Link Speed (mph)		45			45			25			25	
Link Distance (ft)		1040			1416			754			960	
Travel Time (s)		15.8			21.5			20.6			26.2	
Peak Hour Factor	0.90	0.90	0.90	0.90	0.90	0.90	0.90	0.90	0.90	0.90	0.90	0.90
Heavy Vehicles (%)	0%	0%	0%	0%	0%	0%	0%	0%	0%	0%	0%	0%
Adj. Flow (vph)	2	1217	3	1	1193	2	1	0	1	2	0	2
Shared Lane Traffic (%)												
Lane Group Flow (vph)	2	1217	3	1	1195	0	1	1	0	2	2	0
Number of Detectors	1	1	1	1	1		1	1		1	1	
Detector Template												
Leading Detector (ft)	5	5	5	5	5		35	35		35	35	
Trailing Detector (ft)	0	0	0	0	0		-5	-5		-5	-5	
Detector 1 Position(ft)	0	0	0	0	0		-5	-5		-5	-5	
Detector 1 Size(ft)	5	5	5	5	5		40	40		40	40	
Detector 1 Type	CI+Ex	CI+Ex	CI+Ex	CI+Ex	CI+Ex		CI+Ex	CI+Ex		CI+Ex	CI+Ex	
Detector 1 Channel												
Detector 1 Extend (s)	0.0	0.0	0.0	0.0	0.0		0.0	0.0		0.0	0.0	
Detector 1 Queue (s)	0.0	0.0	0.0	0.0	0.0		0.0	0.0		0.0	0.0	
Detector 1 Delay (s)	0.0	0.0	0.0	0.0	0.0		0.0	0.0		0.0	0.0	
Turn Type	Perm	NA	Perm	Perm	NA		Perm	NA		Perm	NA	
Protected Phases		2			6			8			4	
Permitted Phases	2		2	6			8			4		
Detector Phase	2	2	2	6	6		8	8		4	4	
Switch Phase												
Minimum Initial (s)	21.0	21.0	21.0	21.0	21.0		5.0	5.0		5.0	5.0	
Minimum Split (s)	27.0	27.0	27.0	27.0	27.0		11.0	11.0		11.0	11.0	
Total Split (s)	85.0	85.0	85.0	85.0	85.0		15.0	15.0		15.0	15.0	
Total Split (%)	85.0%	85.0%	85.0%	85.0%	85.0%		15.0%	15.0%		15.0%	15.0%	
Maximum Green (s)	79.0	79.0	79.0	79.0	79.0		9.0	9.0		9.0	9.0	
Yellow Time (s)	4.0	4.0	4.0	4.0	4.0		3.0	3.0		3.0	3.0	
All-Red Time (s)	2.0	2.0	2.0	2.0	2.0		3.0	3.0		3.0	3.0	
Lost Time Adjust (s)	-1.0	-1.0	-1.0	-1.0	-1.0		-1.0	-1.0		-1.0	-1.0	
Total Lost Time (s)	5.0	5.0	5.0	5.0	5.0		5.0	5.0		5.0	5.0	

BT Dreshertown, LP
 4: Dryden Road & Welsh Road

2018 Without SAT Peak



Lane Group	EBL	EBT	EBR	WBL	WBT	WBR	NBL	NBT	NBR	SBL	SBT	SBR
Lead/Lag												
Lead-Lag Optimize?												
Vehicle Extension (s)	3.0	3.0	3.0	3.0	3.0		3.0	3.0		3.0	3.0	
Recall Mode	C-Max	C-Max	C-Max	C-Max	C-Max		None	None		None	None	

Intersection Summary

Area Type: Other
 Cycle Length: 100
 Actuated Cycle Length: 100
 Offset: 41 (41%), Referenced to phase 2:EBTL and 6:WBTL, Start of 1st Green
 Natural Cycle: 40
 Control Type: Actuated-Coordinated

Splits and Phases: 4: Dryden Road & Welsh Road

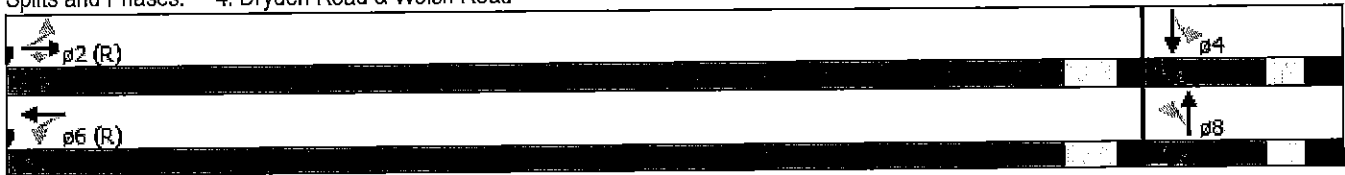

BT Dreshertown, LP
4: Dryden Road & Welsh Road

2018 Without SAT Peak

Movement	EBL	EPT	EBR	WBL	WBT	WBR	NEL	NBT	NBR	SBL	SBT	SBR
Lane Configurations	↗	↕	↘	↙	↕	↗	↖	↖		↖	↖	
Volume (veh/h)	2	1095	3	1	1074	2	1	0	1	2	0	2
Number	5	2	12	1	6	16	3	8	18	7	4	14
Initial Q (Qb), veh	0	0	0	0	0	0	0	0	0	0	0	0
Ped-Bike Adj(A_pbT)	1.00		1.00	1.00		1.00	1.00		1.00	1.00		1.00
Parking Bus, Adj	1.00	1.00	1.00	1.00	1.00	1.00	1.00	1.00	1.00	1.00	1.00	1.00
Adj Sat Flow, veh/h/ln	1809	1809	1881	1809	1809	1809	1809	1881	1881	1800	1872	1872
Adj Flow Rate, veh/h	2	1217	1	1	1193	2	1	0	1	2	0	2
Adj No. of Lanes	1	2	1	1	2	0	1	1	0	1	1	0
Peak Hour Factor	0.90	0.90	0.90	0.90	0.90	0.90	0.90	0.90	0.90	0.90	0.90	0.90
Percent Heavy Veh, %	0	0	0	0	0	0	0	0	0	0	0	0
Cap, veh/h	465	3033	1411	485	3106	5	98	0	28	97	0	28
Arrive On Green	1.00	1.00	1.00	0.88	0.88	0.87	0.02	0.00	0.01	0.02	0.00	0.01
Sat Flow, veh/h	478	3437	1599	468	3521	6	1445	0	1599	1439	0	1591
Grp Volume(v), veh/h	2	1217	1	1	582	613	1	0	1	2	0	2
Grp Sat Flow(s), veh/h/ln	478	1719	1599	468	1719	1808	1445	0	1599	1439	0	1591
Q Serve(g_s), s	0.0	0.0	0.0	0.0	6.0	6.0	0.1	0.0	0.1	0.1	0.0	0.1
Cycle Q Clear(g_c), s	6.1	0.0	0.0	0.0	6.0	6.0	0.1	0.0	0.1	0.1	0.0	0.1
Prop In Lane	1.00		1.00	1.00		0.00	1.00		1.00	1.00		1.00
Lane Grp Cap(c), veh/h	465	3033	1411	485	1516	1595	98	0	28	97	0	28
V/C Ratio(X)	0.00	0.40	0.00	0.00	0.38	0.38	0.01	0.00	0.04	0.02	0.00	0.07
Avail Cap(c_a), veh/h	465	3033	1411	485	1516	1595	216	0	160	216	0	159
HCM Platoon Ratio	2.00	2.00	2.00	1.00	1.00	1.00	1.00	1.00	1.00	1.00	1.00	1.00
Upstream Filter(I)	0.85	0.85	0.85	1.00	1.00	1.00	1.00	0.00	1.00	1.00	0.00	1.00
Uniform Delay (d), s/veh	0.2	0.0	0.0	0.7	1.0	1.0	48.3	0.0	48.8	48.3	0.0	48.8
Incr Delay (d2), s/veh	0.0	0.3	0.0	0.0	0.7	0.7	0.0	0.0	0.5	0.1	0.0	1.1
Initial Q Delay(d3),s/veh	0.0	0.0	0.0	0.0	0.0	0.0	0.0	0.0	0.0	0.0	0.0	0.0
%ile BackOfQ(95%),veh/ln	0.0	0.3	0.0	0.0	5.5	5.8	0.1	0.0	0.1	0.1	0.0	0.1
LnGrp Delay(d),s/veh	0.2	0.3	0.0	0.7	1.8	1.7	48.3	0.0	49.3	48.4	0.0	49.9
LnGrp LOS	A	A	A	A	A	A	D		D	D		D
Approach Vol, veh/h		1220			1196			2				4
Approach Delay, s/veh		0.3			1.8			48.8				49.1
Approach LOS		A			A			D				D
Time	1	2	3	4	5	6	7	8				
Assigned Phs		2		4		6		8				
Phs Duration (G+Y+Rc), s		93.2		6.8		93.2		6.8				
Change Period (Y+Rc), s		6.0		6.0		6.0		6.0				
Max Green Setting (Gmax), s		79.0		9.0		79.0		9.0				
Max Q Clear Time (g_c+I1), s		8.6		2.6		8.5		2.6				
Green Ext Time (p_c), s		10.2		0.0		10.2		0.0				
Intersection Summary												
HCM 2010 Ctrl Delay			1.2									
HCM 2010 LOS			A									

APPENDIX I

**2018 Future with Development
Capacity/Level-of-Service Analysis Worksheets**

BT Dreshertown, LP
 1: Jarrettown Road/Village Road & Welsh Road

2018 With AM Peak

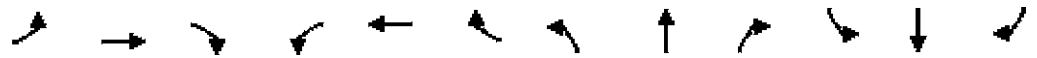

Lane Group	PBL	EBT	EBR	WBL	WBT	WBR	NBL	NBT	NBR	SBL	SBT	SBR
Lane Configurations												
Volume (vph)	56	873	18	287	678	8	18	59	336	9	19	28
Ideal Flow (vphpl)	1800	1800	1800	1800	1800	1800	1800	1800	1800	1800	1800	1800
Lane Width (ft)	12	12	12	11	14	14	12	12	14	15	15	15
Grade (%)		-6%			1%			-1%			1%	
Storage Length (ft)	150		0	100		0	0		175	0		0
Storage Lanes	1		0	1		0	0		1	0		0
Taper Length (ft)	75			75			75			75		
Lane Util. Factor	1.00	1.00	1.00	1.00	1.00	1.00	1.00	1.00	1.00	1.00	1.00	1.00
Frt		0.997			0.998				0.850		0.932	
Flt Protected	0.950			0.950				0.988			0.992	
Satd. Flow (prot)	1727	1810	0	1612	1852	0	0	1760	1640	0	1731	0
Flt Permitted	0.391			0.086				0.920			0.939	
Satd. Flow (perm)	711	1810	0	146	1852	0	0	1639	1640	0	1639	0
Right Turn on Red			Yes			Yes			Yes			Yes
Satd. Flow (RTOR)		1			1				91			29
Link Speed (mph)		45			45			35				35
Link Distance (ft)		1263			605			421				431
Travel Time (s)		19.1			9.2			8.2				8.4
Peak Hour Factor	0.95	0.95	0.95	0.95	0.95	0.95	0.95	0.95	0.95	0.95	0.95	0.95
Heavy Vehicles (%)	2%	2%	7%	2%	3%	0%	0%	2%	0%	11%	0%	7%
Adj. Flow (vph)	59	919	19	302	714	8	19	62	354	9	20	29
Shared Lane Traffic (%)												
Lane Group Flow (vph)	59	938	0	302	722	0	0	81	354	0	58	0
Number of Detectors	1	2		1	2		1	1	1	1	1	
Detector Template	Left			Left			Left	Thru	Right	Left	Thru	
Leading Detector (ft)	5	330		35	330		20	35	35	20	35	
Trailing Detector (ft)	0	0		-5	0		0	-5	-5	0	-5	
Detector 1 Position(ft)	0	0		-5	0		0	-5	-5	0	-5	
Detector 1 Size(ft)	5	6		40	6		20	40	40	20	40	
Detector 1 Type	CI+Ex	CI+Ex		CI+Ex	CI+Ex		CI+Ex	CI+Ex	CI+Ex	CI+Ex	CI+Ex	
Detector 1 Channel												
Detector 1 Extend (s)	0.0	0.0		0.0	0.0		0.0	0.0	0.0	0.0	0.0	
Detector 1 Queue (s)	0.0	0.0		0.0	0.0		0.0	0.0	0.0	0.0	0.0	
Detector 1 Delay (s)	0.0	0.0		0.0	0.0		0.0	0.0	0.0	0.0	0.0	
Detector 2 Position(ft)		324			324							
Detector 2 Size(ft)		6			6							
Detector 2 Type		CI+Ex			CI+Ex							
Detector 2 Channel												
Detector 2 Extend (s)		0.0			0.0							
Turn Type	Perm	NA		pm+pt	NA		Perm	NA	pm+ov	Perm	NA	
Protected Phases		2		1	6			8	1		4	
Permitted Phases	2			6			8		8	4		
Detector Phase	2	2		1	6		8	8	1	4	4	
Switch Phase												
Minimum Initial (s)	15.0	15.0		3.0	15.0		7.0	7.0	3.0	7.0	7.0	
Minimum Split (s)	22.0	22.0		10.0	22.0		13.0	13.0	10.0	13.0	13.0	
Total Split (s)	65.0	65.0		32.0	97.0		23.0	23.0	32.0	23.0	23.0	
Total Split (%)	54.2%	54.2%		26.7%	80.8%		19.2%	19.2%	26.7%	19.2%	19.2%	

BT Dreshertown, LP
 1: Jarrettown Road/Village Road & Welsh Road

2018 With AM Peak



Lane Group	EBL	EBT	EBR	WBL	WBT	WBR	NBL	NBT	NBR	SBL	SBT	SBR
Maximum Green (s)	58.0	58.0		25.0	90.0		17.0	17.0	25.0	17.0	17.0	
Yellow Time (s)	5.0	5.0		5.0	5.0		4.0	4.0	5.0	4.0	4.0	
All-Red Time (s)	2.0	2.0		2.0	2.0		2.0	2.0	2.0	2.0	2.0	
Lost Time Adjust (s)	-1.0	-1.0		-1.0	-1.0			-1.0	-1.0			-1.0
Total Lost Time (s)	6.0	6.0		6.0	6.0			5.0	6.0			5.0
Lead/Lag	Lag	Lag		Lead					Lead			
Lead-Lag Optimize?												
Vehicle Extension (s)	3.0	3.0		3.0	3.0		3.0	3.0	3.0	3.0	3.0	
Recall Mode	C-Max	C-Max		None	C-Max		None	None	None	None	None	

Intersection Summary

Area Type: Other
 Cycle Length: 120
 Actuated Cycle Length: 120
 Offset: 33 (28%), Referenced to phase 2:EBTL and 6:WBTL, Start of 1st Green
 Natural Cycle: 90
 Control Type: Actuated-Coordinated

Splits and Phases: 1: Jarrettown Road/Village Road & Welsh Road



BT Dreshertown, LP
 1: Jarrettown Road/Village Road & Welsh Road

2018 With AM Peak

Movement	EBL	EBT	EBR	WBL	WBT	WBR	NBL	NBT	NER	SBL	SBT	SBR
Lane Configurations	↖	↗		↖	↗		↖	↗		↖	↗	↖
Volume (veh/h)	56	873	18	287	678	8	18	59	336	9	19	28
Number	5	2	12	1	6	16	3	8	18	7	4	14
Initial Q (Qb), veh	0	0	0	0	0	0	0	0	0	0	0	0
Ped-Bike Adj(A_pbT)	1.00		1.00	1.00		1.00	1.00		1.00	1.00		1.00
Parking Bus, Adj	1.00	1.00	1.00	1.00	1.00	1.00	1.00	1.00	1.00	1.00	1.00	1.00
Adj Sat Flow, veh/h/ln	1818	1816	1854	1756	1809	1863	1809	1782	1881	1863	1770	1863
Adj Flow Rate, veh/h	59	919	17	302	714	7	19	62	327	9	20	27
Adj No. of Lanes	1	1	0	1	1	0	0	1	1	0	1	0
Peak Hour Factor	0.95	0.95	0.95	0.95	0.95	0.95	0.95	0.95	0.95	0.95	0.95	0.95
Percent Heavy Veh, %	2	2	2	2	3	3	2	2	0	0	0	0
Cap, veh/h	500	1042	19	351	1356	13	75	217	435	53	101	112
Arrive On Green	0.59	0.59	0.58	0.12	0.76	0.75	0.14	0.15	0.15	0.14	0.15	0.14
Sat Flow, veh/h	751	1777	33	1672	1788	18	256	1448	1599	123	676	744
Grp Volume(v), veh/h	59	0	936	302	0	721	81	0	327	56	0	0
Grp Sat Flow(s),veh/h/ln	751	0	1810	1672	0	1806	1704	0	1599	1543	0	0
Q Serve(g_s), s	4.2	0.0	53.2	10.3	0.0	19.3	0.0	0.0	18.0	0.0	0.0	0.0
Cycle Q Clear(g_c), s	4.3	0.0	53.2	10.3	0.0	19.3	4.9	0.0	18.0	3.7	0.0	0.0
Prop In Lane	1.00		0.02	1.00		0.01	0.23		1.00	0.16		0.48
Lane Grp Cap(c), veh/h	500	0	1061	351	0	1369	278	0	435	253	0	0
V/C Ratio(X)	0.12	0.00	0.88	0.86	0.00	0.53	0.29	0.00	0.75	0.22	0.00	0.00
Avail Cap(c_a), veh/h	500	0	1061	509	0	1369	278	0	435	253	0	0
HCM Platoon Ratio	1.00	1.00	1.00	1.00	1.00	1.00	1.00	1.00	1.00	1.00	1.00	1.00
Upstream Filter(I)	1.00	0.00	1.00	1.00	0.00	1.00	1.00	0.00	1.00	1.00	0.00	0.00
Uniform Delay (d), s/veh	11.2	0.0	21.3	29.9	0.0	5.8	45.5	0.0	40.0	45.2	0.0	0.0
Incr Delay (d2), s/veh	0.5	0.0	10.6	9.8	0.0	1.5	0.6	0.0	7.2	0.4	0.0	0.0
Initial Q Delay(d3),s/veh	0.0	0.0	0.0	0.0	0.0	0.0	0.0	0.0	0.0	0.0	0.0	0.0
%ile BackOfQ(95%),veh/ln	1.7	0.0	38.3	15.9	0.0	15.1	4.4	0.0	16.2	3.0	0.0	0.0
LnGrp Delay(d),s/veh	11.6	0.0	31.8	39.7	0.0	7.3	46.1	0.0	47.2	45.6	0.0	0.0
LnGrp LOS	B		C	D		A	D		D	D		
Approach Vol, veh/h		995			1023			408				56
Approach Delay, s/veh		30.6			16.9			46.9				45.6
Approach LOS		C			B			D				D

Timer	1	2	3	4	5	6	7	8
Assigned Phs	1	2		4		6		8
Phs Duration (G+Y+Rc), s	20.6	76.4		23.0		97.0		23.0
Change Period (Y+Rc), s	7.0	7.0		6.0		7.0		6.0
Max Green Setting (Gmax), s	25.0	58.0		17.0		90.0		17.0
Max Q Clear Time (g_c+1), s	12.8	55.2		5.7		21.3		20.5
Green Ext Time (p_c), s	0.8	2.8		1.4		57.7		0.0

Intersection Summary	
HCM 2010 Ctrl Delay	28.0
HCM 2010 LOS	C

BT Dreshertown, LP
2: Welsh Road & Dresher Road

2018 With AM Peak

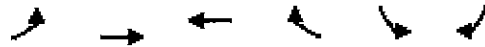

Lane Group	EBL	EBT	WBT	WBR	SBL	SBR
Lane Configurations	↘	↑↑	↑↑	↗	↘↗	↗
Volume (vph)	413	835	712	599	679	310
Ideal Flow (vphpl)	1800	1800	1800	1800	1800	1800
Lane Width (ft)	10	11	11	11	12	13
Grade (%)		-1%	1%		1%	
Storage Length (ft)	225			210	0	415
Storage Lanes	1			1	2	1
Taper Length (ft)	75				75	
Lane Util. Factor	1.00	0.95	0.95	1.00	0.97	1.00
Frt				0.850		0.850
Flt Protected	0.950				0.950	
Satd. Flow (prot)	1588	3290	3194	1443	3268	1542
Flt Permitted	0.202				0.950	
Satd. Flow (perm)	338	3290	3194	1443	3268	1542
Right Turn on Red				Yes		Yes
Satd. Flow (RTOR)				228		40
Link Speed (mph)		45	45		35	
Link Distance (ft)		475	550		970	
Travel Time (s)		7.2	8.3		18.9	
Peak Hour Factor	0.94	0.94	0.94	0.94	0.94	0.94
Heavy Vehicles (%)	1%	1%	3%	2%	1%	2%
Adj. Flow (vph)	439	888	757	637	722	330
Shared Lane Traffic (%)						
Lane Group Flow (vph)	439	888	757	637	722	330
Number of Detectors	1	1	1	1	1	1
Detector Template						
Leading Detector (ft)	35	5	5	5	35	35
Trailing Detector (ft)	-5	0	0	0	-5	-5
Detector 1 Position(ft)	-5	0	0	0	-5	-5
Detector 1 Size(ft)	40	5	5	5	40	40
Detector 1 Type	CI+Ex	CI+Ex	CI+Ex	CI+Ex	CI+Ex	CI+Ex
Detector 1 Channel						
Detector 1 Extend (s)	0.0	0.0	0.0	0.0	0.0	0.0
Detector 1 Queue (s)	0.0	0.0	0.0	0.0	0.0	0.0
Detector 1 Delay (s)	0.0	0.0	0.0	0.0	0.0	0.0
Turn Type	pm+pt	NA	NA	pm+ov	Prot	pm+ov
Protected Phases	5	2	6	4	4	5
Permitted Phases	2			6		4
Detector Phase	5	2	6	4	4	5
Switch Phase						
Minimum Initial (s)	3.0	20.0	20.0	7.0	7.0	3.0
Minimum Split (s)	9.0	26.0	26.0	14.0	14.0	9.0
Total Split (s)	40.0	82.0	42.0	38.0	38.0	40.0
Total Split (%)	33.3%	68.3%	35.0%	31.7%	31.7%	33.3%
Maximum Green (s)	34.0	76.0	36.0	31.0	31.0	34.0
Yellow Time (s)	4.0	4.0	4.0	4.0	4.0	4.0
All-Red Time (s)	2.0	2.0	2.0	3.0	3.0	2.0
Lost Time Adjust (s)	-1.0	-1.0	-1.0	-1.0	-1.0	-1.0
Total Lost Time (s)	5.0	5.0	5.0	6.0	6.0	5.0

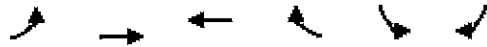

Lane Group	EBL	EBT	WBT	WBR	SEB	SBR
Lead/Lag	Lead		Lag		Lead	
Lead-Lag Optimize?						
Vehicle Extension (s)	3.0	3.0	3.0	3.0	3.0	3.0
Recall Mode	None	C-Max	C-Max	None	None	None
Act Effct Green (s)	77.8	77.8	43.6	79.8	31.2	66.4
Actuated g/C Ratio	0.65	0.65	0.36	0.66	0.26	0.55
v/c Ratio	0.84	0.42	0.65	0.62	0.85	0.38
Control Delay	26.2	6.2	38.2	13.1	52.9	13.6
Queue Delay	0.0	0.1	0.0	0.4	0.0	0.0
Total Delay	26.2	6.2	38.2	13.4	52.9	13.6
LOS	C	A	D	B	D	B
Approach Delay		12.8	26.9		40.6	
Approach LOS		B	C		D	
Queue Length 50th (ft)	154	84	286	203	272	110
Queue Length 95th (ft)	m226	m99	367	364	347	160
Internal Link Dist (ft)		395	470		890	
Turn Bay Length (ft)	225			210		415
Base Capacity (vph)	583	2134	1160	1044	871	943
Starvation Cap Reductn	0	0	0	100	0	0
Spillback Cap Reductn	0	222	0	0	0	0
Storage Cap Reductn	0	0	0	0	0	0
Reduced v/c Ratio	0.75	0.46	0.65	0.67	0.83	0.35

Intersection Summary

Area Type: Other
 Cycle Length: 120
 Actuated Cycle Length: 120
 Offset: 85 (71%), Referenced to phase 2:EBTL and 6:WBT, Start of 1st Green
 Natural Cycle: 70
 Control Type: Actuated-Coordinated
 Maximum v/c Ratio: 0.85
 Intersection Signal Delay: 25.8
 Intersection Capacity Utilization 78.7%
 Analysis Period (min) 15
 m Volume for 95th percentile queue is metered by upstream signal.

Intersection LOS: C
 ICU Level of Service D

Splits and Phases: 2: Welsh Road & Dresher Road

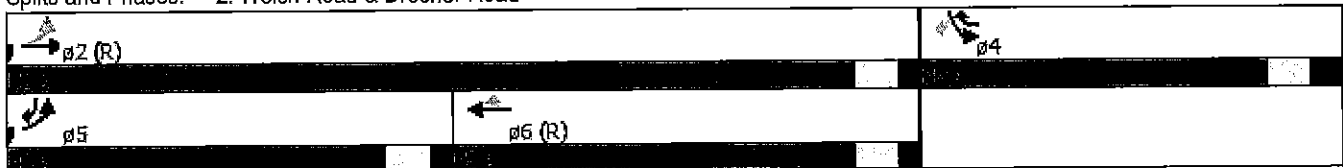

BT Dreshertown, LP
3: Dreshertown Road & Welsh Road

2018 With AM Peak

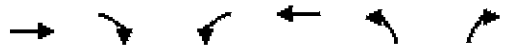

Lane Group	EBT	EBR	WBL	WBT	NBL	NBR
Lane Configurations	↑↑	↑	↓	↑↑	↓↓	↑
Volume (vph)	956	558	421	1012	300	384
Ideal Flow (vphpl)	1800	1800	1800	1800	1800	1800
Lane Width (ft)	11	15	10	12	12	15
Grade (%)	-2%			1%	1%	
Storage Length (ft)		150	175		0	350
Storage Lanes		1	1		2	2
Taper Length (ft)			75		75	
Lane Util. Factor	0.95	1.00	1.00	0.95	0.97	1.00
Frnt		0.850				0.850
Flt Protected			0.950		0.950	
Satd. Flow (prot)	3306	1650	1542	3304	3174	1626
Flt Permitted			0.163		0.950	
Satd. Flow (perm)	3306	1650	265	3304	3174	1626
Right Turn on Red		Yes				Yes
Satd. Flow (RTOR)		367				30
Link Speed (mph)	45			45	40	
Link Distance (ft)	550			1040	600	
Travel Time (s)	8.3			15.8	10.2	
Peak Hour Factor	0.98	0.98	0.98	0.98	0.98	0.98
Heavy Vehicles (%)	1%	3%	3%	3%	4%	3%
Adj. Flow (vph)	976	569	430	1033	306	392
Shared Lane Traffic (%)						
Lane Group Flow (vph)	976	569	430	1033	306	392
Number of Detectors	1	1	1	1	1	1
Detector Template						
Leading Detector (ft)	5	5	35	5	35	35
Trailing Detector (ft)	0	0	-5	0	-5	-5
Detector 1 Position(ft)	0	0	-5	0	-5	-5
Detector 1 Size(ft)	5	5	40	5	40	40
Detector 1 Type	CI+Ex	CI+Ex	CI+Ex	CI+Ex	CI+Ex	CI+Ex
Detector 1 Channel						
Detector 1 Extend (s)	0.0	0.0	0.0	0.0	0.0	0.0
Detector 1 Queue (s)	0.0	0.0	0.0	0.0	0.0	0.0
Detector 1 Delay (s)	0.0	0.0	0.0	0.0	0.0	0.0
Turn Type	NA	Perm	pm+pt	NA	Prot	pm+ov
Protected Phases	2		1	6	8	1
Permitted Phases		2	6			8
Detector Phase	2	2	1	6	8	1
Switch Phase						
Minimum Initial (s)	20.0	20.0	3.0	20.0	7.0	3.0
Minimum Split (s)	27.0	27.0	10.0	27.0	14.0	10.0
Total Split (s)	50.0	50.0	45.0	95.0	25.0	45.0
Total Split (%)	41.7%	41.7%	37.5%	79.2%	20.8%	37.5%
Maximum Green (s)	43.0	43.0	38.0	88.0	18.0	38.0
Yellow Time (s)	5.0	5.0	5.0	5.0	4.0	5.0
All-Red Time (s)	2.0	2.0	2.0	2.0	3.0	2.0
Lost Time Adjust (s)	-1.0	-1.0	-1.0	-1.0	-1.0	-1.0
Total Lost Time (s)	6.0	6.0	6.0	6.0	6.0	6.0

BT Dreshertown, LP
 3: Dreshertown Road & Welsh Road

2018 With AM Peak



Lane Group	EBT	EBR	WBL	WBTL	NBL	NBR
Lead/Lag	Lag	Lag	Lead			Lead
Lead-Lag Optimize?						
Vehicle Extension (s)	3.0	3.0	3.0	3.0	3.0	3.0
Recall Mode	C-Max	C-Max	None	C-Max	None	None

Intersection Summary

Area Type: Other
 Cycle Length: 120
 Actuated Cycle Length: 120
 Offset: 85 (71%), Referenced to phase 2:EBT and 6:WBTL, Start of 1st Green
 Natural Cycle: 65
 Control Type: Actuated-Coordinated

Splits and Phases: 3: Dreshertown Road & Welsh Road

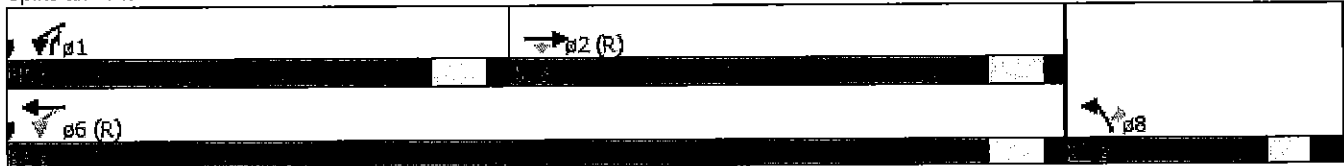



Movement	EBT	EBR	WBL	WBT	NBL	NBR
Lane Configurations	↑↑	↑	↑	↑↑	↑↑	↑
Volume (veh/h)	956	558	421	1012	300	384
Number	2	12	1	6	3	18
Initial Q (Qb), veh	0	0	0	0	0	0
Ped-Bike Adj(A_pbT)		1.00	1.00		1.00	1.00
Parking Bus, Adj	1.00	1.00	1.00	1.00	1.00	1.00
Adj Sat Flow, veh/h/ln	1800	1836	1739	1739	1722	1808
Adj Flow Rate, veh/h	976	525	430	1033	306	309
Adj No. of Lanes	2	1	1	2	2	1
Peak Hour Factor	0.98	0.98	0.98	0.98	0.98	0.98
Percent Heavy Veh, %	1	3	3	3	4	3
Cap, veh/h	1799	821	515	2450	504	498
Arrive On Green	1.00	1.00	0.33	1.00	0.16	0.16
Sat Flow, veh/h	3510	1560	1656	3391	3182	1537
Grp Volume(v), veh/h	976	525	430	1033	306	309
Grp Sat Flow(s),veh/h/ln	1710	1560	1656	1652	1591	1537
Q Serve(g_s), s	0.0	0.0	14.9	0.0	10.7	19.0
Cycle Q Clear(g_c), s	0.0	0.0	14.9	0.0	10.7	19.0
Prop In Lane		1.00	1.00		1.00	1.00
Lane Grp Cap(c), veh/h	1799	821	515	2450	504	498
V/C Ratio(X)	0.54	0.64	0.84	0.42	0.61	0.62
Avail Cap(c_a), veh/h	1799	821	779	2450	504	498
HCM Platoon Ratio	2.00	2.00	2.00	2.00	1.00	1.00
Upstream Filter(I)	0.76	0.76	0.85	0.85	1.00	1.00
Uniform Delay (d), s/veh	0.0	0.0	6.8	0.0	47.0	34.3
Incr Delay (d2), s/veh	0.9	2.9	4.3	0.5	2.1	2.4
Initial Q Delay(d3),s/veh	0.0	0.0	0.0	0.0	0.0	0.0
%ile BackOfQ(95%),veh/ln	0.4	1.2	11.2	0.3	8.5	13.9
LnGrp Delay(d),s/veh	0.9	2.9	11.1	0.5	49.1	36.7
LnGrp LOS	A	A	B	A	D	D
Approach Vol, veh/h	1501			1463	615	
Approach Delay, s/veh	1.6			3.6	42.9	
Approach LOS	A			A	D	

Phase	1	2	3	4	5	6	7	8
Assigned Phs	1	2				6		8
Phs Duration (G+Y+Rc), s	25.9	69.1				95.0		25.0
Change Period (Y+Rc), s	7.0	7.0				7.0		7.0
Max Green Setting (Gmax), s	38.0	43.0				88.0		18.0
Max Q Clear Time (g_c+I1), s	17.4	2.5				2.5		21.5
Green Ext Time (p_c), s	1.4	11.7				12.4		0.0

Intersection Summary	
HCM 2010 Ctrl Delay	9.5
HCM 2010 LOS	A

BT Dreshertown, LP
4: Dryden Road & Welsh Road

2018 With AM Peak



Lane Group	EBL	EBT	EBR	WBL	WBT	WBR	NBL	NBT	NBR	SBL	SBT	SBR
Lane Configurations	↖	↕	↗	↖	↕	↗	↖	↕	↗	↖	↕	↗
Volume (vph)	1	1251	98	63	1491	1	5	0	11	2	0	0
Ideal Flow (vphpl)	1800	1800	1800	1800	1800	1800	1800	1800	1800	1800	1800	1800
Lane Width (ft)	10	12	14	10	12	12	11	15	15	12	14	14
Grade (%)		-1%			-1%			-1%			0%	
Storage Length (ft)	150		225	175		0	110		0	150		0
Storage Lanes	1		1	1		0	1		0	1		0
Taper Length (ft)	75			75			75			75		
Lane Util. Factor	1.00	0.95	1.00	1.00	0.95	0.95	1.00	1.00	1.00	1.00	1.00	1.00
Frnt			0.850					0.850				
Flt Protected	0.950			0.950			0.950			0.950		
Satd. Flow (prot)	1604	3403	1640	1573	3370	0	1661	1691	0	1710	1920	0
Flt Permitted	0.146			0.195								
Satd. Flow (perm)	247	3403	1640	323	3370	0	1749	1691	0	1800	1920	0
Right Turn on Red			Yes			Yes			Yes			Yes
Satd. Flow (RTOR)			105					135				
Link Speed (mph)		45			45			25			25	
Link Distance (ft)		1040			1416			754			960	
Travel Time (s)		15.8			21.5			20.6			26.2	
Peak Hour Factor	0.93	0.93	0.93	0.93	0.93	0.93	0.93	0.93	0.93	0.93	0.93	0.93
Heavy Vehicles (%)	0%	1%	0%	2%	2%	0%	0%	0%	0%	0%	0%	0%
Adj. Flow (vph)	1	1345	105	68	1603	1	5	0	12	2	0	0
Shared Lane Traffic (%)												
Lane Group Flow (vph)	1	1345	105	68	1604	0	5	12	0	2	0	0
Number of Detectors	1	1	1	1	1		1	1		1	1	
Detector Template												
Leading Detector (ft)	5	5	5	5	5		35	35		35	35	
Trailing Detector (ft)	0	0	0	0	0		-5	-5		-5	-5	
Detector 1 Position(ft)	0	0	0	0	0		-5	-5		-5	-5	
Detector 1 Size(ft)	5	5	5	5	5		40	40		40	40	
Detector 1 Type	CI+Ex	CI+Ex	CI+Ex	CI+Ex	CI+Ex		CI+Ex	CI+Ex		CI+Ex	CI+Ex	
Detector 1 Channel												
Detector 1 Extend (s)	0.0	0.0	0.0	0.0	0.0		0.0	0.0		0.0	0.0	
Detector 1 Queue (s)	0.0	0.0	0.0	0.0	0.0		0.0	0.0		0.0	0.0	
Detector 1 Delay (s)	0.0	0.0	0.0	0.0	0.0		0.0	0.0		0.0	0.0	
Turn Type	Perm	NA	Perm	Perm	NA		Perm	NA		Perm		
Protected Phases		2			6			8			4	
Permitted Phases	2		2	6			8			4		
Detector Phase	2	2	2	6	6		8	8		4	4	
Switch Phase												
Minimum Initial (s)	21.0	21.0	21.0	21.0	21.0		5.0	5.0		5.0	5.0	
Minimum Split (s)	27.0	27.0	27.0	27.0	27.0		11.0	11.0		11.0	11.0	
Total Split (s)	107.0	107.0	107.0	107.0	107.0		13.0	13.0		13.0	13.0	
Total Split (%)	89.2%	89.2%	89.2%	89.2%	89.2%		10.8%	10.8%		10.8%	10.8%	
Maximum Green (s)	101.0	101.0	101.0	101.0	101.0		7.0	7.0		7.0	7.0	
Yellow Time (s)	4.0	4.0	4.0	4.0	4.0		3.0	3.0		3.0	3.0	
All-Red Time (s)	2.0	2.0	2.0	2.0	2.0		3.0	3.0		3.0	3.0	
Lost Time Adjust (s)	-1.0	-1.0	-1.0	-1.0	-1.0		-1.0	-1.0		-1.0	-1.0	
Total Lost Time (s)	5.0	5.0	5.0	5.0	5.0		5.0	5.0		5.0	5.0	

BT Dreshertown, LP
 4: Dryden Road & Welsh Road

2018 With AM Peak

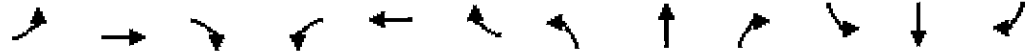

Lane Group	EBL	EBT	EBR	WBL	WBT	WBR	NEL	NBT	NBR	SBL	SBT	SBR
Lead/Lag												
Lead-Lag Optimize?												
Vehicle Extension (s)	3.0	3.0	3.0	3.0	3.0		3.0	3.0		3.0	3.0	
Recall Mode	C-Max	C-Max	C-Max	C-Max	C-Max		None	None		None	None	

Intersection Summary

Area Type: Other
 Cycle Length: 120
 Actuated Cycle Length: 120
 Offset: 62 (52%), Referenced to phase 2:EBTL and 6:WBTL, Start of 1st Green
 Natural Cycle: 45
 Control Type: Actuated-Coordinated

Splits and Phases: 4: Dryden Road & Welsh Road



Movement	EBL	EBT	EBR	WBL	WBT	WBR	NEB	NBT	NBR	SBL	SEB	SBR
Lane Configurations												
Volume (veh/h)	1	1251	98	63	1491	1	5	0	11	2	0	0
Number	5	2	12	1	6	16	3	8	18	7	4	14
Initial Q (Qb), veh	0	0	0	0	0	0	0	0	0	0	0	0
Ped-Bike Adj(A_pbT)	1.00		1.00	1.00		1.00	1.00		1.00	1.00		1.00
Parking Bus, Adj	1.00	1.00	1.00	1.00	1.00	1.00	1.00	1.00	1.00	1.00	1.00	1.00
Adj Sat Flow, veh/h/ln	1809	1791	1881	1774	1774	1809	1809	1881	1881	1800	1872	1872
Adj Flow Rate, veh/h	1	1345	103	68	1603	1	5	0	12	2	0	0
Adj No. of Lanes	1	2	1	1	2	0	1	1	0	1	1	0
Peak Hour Factor	0.93	0.93	0.93	0.93	0.93	0.93	0.93	0.93	0.93	0.93	0.93	0.93
Percent Heavy Veh, %	0	1	0	2	2	2	0	0	0	0	0	0
Cap, veh/h	316	3025	1421	387	3072	2	100	0	45	95	52	0
Arrive On Green	1.00	1.00	1.00	0.89	0.89	0.88	0.03	0.00	0.02	0.03	0.00	0.00
Sat Flow, veh/h	323	3403	1599	368	3456	2	1447	0	1599	1424	1872	0
Grp Volume(v), veh/h	1	1345	103	68	781	823	5	0	12	2	0	0
Grp Sat Flow(s),veh/h/ln	323	1702	1599	368	1685	1773	1447	0	1599	1424	1872	0
Q Serve(g_s), s	0.0	0.0	0.0	3.0	11.5	11.5	0.4	0.0	0.9	0.2	0.0	0.0
Cycle Q Clear(g_c), s	11.6	0.0	0.0	3.0	11.5	11.5	0.4	0.0	0.9	0.6	0.0	0.0
Prop In Lane	1.00		1.00	1.00		0.00	1.00		1.00	1.00		0.00
Lane Grp Cap(c), veh/h	316	3025	1421	387	1497	1576	100	0	45	95	52	0
V/C Ratio(X)	0.00	0.44	0.07	0.18	0.52	0.52	0.05	0.00	0.27	0.02	0.00	0.00
Avail Cap(c_a), veh/h	316	3025	1421	387	1497	1576	156	0	107	150	125	0
HCM Platoon Ratio	2.00	2.00	2.00	1.00	1.00	1.00	1.00	1.00	1.00	1.00	1.00	1.00
Upstream Filter(I)	0.75	0.75	0.75	1.00	1.00	1.00	1.00	0.00	1.00	1.00	0.00	0.00
Uniform Delay (d), s/veh	0.6	0.0	0.0	0.9	1.4	1.4	56.9	0.0	57.6	57.2	0.0	0.0
Incr Delay (d2), s/veh	0.0	0.4	0.1	1.0	1.3	1.2	0.2	0.0	3.2	0.1	0.0	0.0
Initial Q Delay(d3),s/veh	0.0	0.0	0.0	0.0	0.0	0.0	0.0	0.0	0.0	0.0	0.0	0.0
%ile BackOfQ(95%),veh/ln	0.0	0.3	0.1	0.7	9.7	10.1	0.3	0.0	0.8	0.1	0.0	0.0
LnGrp Delay(d),s/veh	0.6	0.4	0.1	1.9	2.7	2.6	57.1	0.0	60.8	57.2	0.0	0.0
LnGrp LOS	A	A	A	A	A	A	E		E	E		
Approach Vol, veh/h		1449			1672			17				2
Approach Delay, s/veh		0.3			2.6			59.7				57.2
Approach LOS		A			A			E				E
Time	1	2	3	4	5	6	7	8				
Assigned Phs		2		4		6		8				
Phs Duration (G+Y+Rc), s		111.7		8.3		111.7		8.3				
Change Period (Y+Rc), s		6.0		6.0		6.0		6.0				
Max Green Setting (Gmax), s		101.0		7.0		101.0		7.0				
Max Q Clear Time (g_c+I1), s		14.1		3.1		14.0		2.9				
Green Ext Time (p_c), s		20.4		0.0		20.4		0.0				
Intersection Summary												
HCM 2010 Ctrl Delay			1.9									
HCM 2010 LOS			A									



Lane Group	WBL	WBR	NBT	NBR	SBL	SBR
Lane Configurations						
Volume (vph)	7	11	675	4	6	973
Ideal Flow (vphpl)	1800	1800	1800	1800	1800	1800
Grade (%)	0%		1%			0%
Lane Util. Factor	1.00	1.00	1.00	1.00	1.00	1.00
Friction	0.917		0.999			
Fit Protected	0.981					
Satd. Flow (prot)	1587	0	1737	0	0	1748
Fit Permitted	0.981					
Satd. Flow (perm)	1587	0	1737	0	0	1748
Link Speed (mph)	25		40			40
Link Distance (ft)	425		608			600
Travel Time (s)	11.6		10.4			10.2
Peak Hour Factor	0.98	0.98	0.98	0.98	0.98	0.98
Heavy Vehicles (%)	2%	2%	3%	2%	2%	3%
Adj. Flow (vph)	7	11	689	4	6	993
Shared Lane Traffic (%)						
Lane Group Flow (vph)	18	0	693	0	0	999
Sign Control	Stop		Free			Free

Intersection Summary

Area Type: Other

Control Type: Unsignalized

Intersection	
Int Delay, s/veh	0.3

Movement	WBL	WBR	NBT	NBR	SBL	SBT
Vol, veh/h	7	11	675	4	6	973
Conflicting Peds, #/hr	0	0	0	0	0	0
Sign Control	Stop	Stop	Free	Free	Free	Free
RT Channelized	-	None	-	None	-	None
Storage Length	0	-	-	-	-	-
Veh in Median Storage, #	0	-	0	-	-	0
Grade, %	0	-	1	-	-	0
Peak Hour Factor	98	98	98	98	98	98
Heavy Vehicles, %	2	2	3	2	2	3
Mvmt Flow	7	11	689	4	6	993

Major/Minor	Minor1	Major1	Major2
Conflicting Flow All	1696	691	693
Stage 1	691	-	-
Stage 2	1005	-	-
Critical Hdwy	6.42	6.22	4.3
Critical Hdwy Stg 1	5.42	-	-
Critical Hdwy Stg 2	5.42	-	-
Follow-up Hdwy	3	3.1	3
Pot Cap-1 Maneuver	109	467	690
Stage 1	558	-	-
Stage 2	390	-	-
Platoon blocked, %	-	-	-
Mov Cap-1 Maneuver	107	467	690
Mov Cap-2 Maneuver	107	-	-
Stage 1	558	-	-
Stage 2	383	-	-

Approach	WB	NB	SB
HCM Control Delay, s	24.6	0	0.1
HCM LOS	C		

Minor Lane/Major Mvmt	NBT	NBR	WBL	SBL	SBT
Capacity (veh/h)	-	-	202	690	-
HCM Lane V/C Ratio	-	-	0.091	0.009	-
HCM Control Delay (s)	-	-	24.6	10.3	0
HCM Lane LOS	-	-	C	B	A
HCM 95th %tile Q(veh)	-	-	0.3	0	-

BT Dreshertown, LP
1: Jarretstown Road/Village Road & Welsh Road

2018 With PM Peak



Lane Group	EBL	EBT	EBR	WBL	WBT	WBR	NBL	NBT	NBR	SBL	SBT	SBR
Lane Configurations	↙	↗		↙	↗			↗	↗		↕	
Volume (vph)	21	799	29	262	980	14	21	20	263	41	91	105
Ideal Flow (vphpl)	1800	1800	1800	1800	1800	1800	1800	1800	1800	1800	1800	1800
Lane Width (ft)	12	12	12	11	14	14	12	12	14	15	15	15
Grade (%)		-6%			1%			-1%			1%	
Storage Length (ft)	150		0	100		0	0		175	0		0
Storage Lanes	1		0	1		0	0		1	0		0
Taper Length (ft)	75			75			75			75		
Lane Util. Factor	1.00	1.00	1.00	1.00	1.00	1.00	1.00	1.00	1.00	1.00	1.00	1.00
Frt		0.995			0.998				0.850		0.940	
Flt Protected	0.950			0.950				0.975			0.991	
Satd. Flow (prot)	1761	1827	0	1645	1907	0	0	1764	1640	0	1826	0
Flt Permitted	0.229			0.086				0.650			0.935	
Satd. Flow (perm)	425	1827	0	149	1907	0	0	1176	1640	0	1723	0
Right Turn on Red			Yes			Yes			Yes			Yes
Satd. Flow (RTOR)		2			1				98		31	
Link Speed (mph)		45			45			35			35	
Link Distance (ft)		1263			605			421			431	
Travel Time (s)		19.1			9.2			8.2			8.4	
Peak Hour Factor	0.96	0.96	0.96	0.96	0.96	0.96	0.96	0.96	0.96	0.96	0.96	0.96
Heavy Vehicles (%)	0%	1%	0%	0%	0%	0%	0%	0%	0%	3%	0%	0%
Adj. Flow (vph)	22	832	30	273	1021	15	22	21	274	43	95	109
Shared Lane Traffic (%)												
Lane Group Flow (vph)	22	862	0	273	1036	0	0	43	274	0	247	0
Number of Detectors	1	2		1	2		1	1	1	1	1	
Detector Template	Left			Left			Left	Thru	Right	Left	Thru	
Leading Detector (ft)	5	330		35	330		20	35	35	20	35	
Trailing Detector (ft)	0	0		-5	0		0	-5	-5	0	-5	
Detector 1 Position(ft)	0	0		-5	0		0	-5	-5	0	-5	
Detector 1 Size(ft)	5	6		40	6		20	40	40	20	40	
Detector 1 Type	CI+Ex	CI+Ex		CI+Ex	CI+Ex		CI+Ex	CI+Ex	CI+Ex	CI+Ex	CI+Ex	
Detector 1 Channel												
Detector 1 Extend (s)	0.0	0.0		0.0	0.0		0.0	0.0	0.0	0.0	0.0	
Detector 1 Queue (s)	0.0	0.0		0.0	0.0		0.0	0.0	0.0	0.0	0.0	
Detector 1 Delay (s)	0.0	0.0		0.0	0.0		0.0	0.0	0.0	0.0	0.0	
Detector 2 Position(ft)		324			324							
Detector 2 Size(ft)		6			6							
Detector 2 Type		CI+Ex			CI+Ex							
Detector 2 Channel												
Detector 2 Extend (s)		0.0			0.0							
Turn Type	Perm	NA		pm+pt	NA		Perm	NA	pm+ov	Perm	NA	
Protected Phases		2		1	6			8	1		4	
Permitted Phases	2			6			8		8	4		
Detector Phase	2	2		1	6		8	8	1	4	4	
Switch Phase												
Minimum Initial (s)	15.0	15.0		3.0	15.0		7.0	7.0	3.0	7.0	7.0	
Minimum Split (s)	22.0	22.0		10.0	22.0		13.0	13.0	10.0	13.0	13.0	
Total Split (s)	61.0	61.0		26.0	87.0		33.0	33.0	26.0	33.0	33.0	
Total Split (%)	50.8%	50.8%		21.7%	72.5%		27.5%	27.5%	21.7%	27.5%	27.5%	

1: Jarrettown Road/Village Road & Welsh Road



Lane Group	EBL	EBT	EBR	WBL	WBT	WBR	NBL	NBT	NBR	SBL	SBT	SBR
Maximum Green (s)	54.0	54.0		19.0	80.0		27.0	27.0	19.0	27.0	27.0	
Yellow Time (s)	5.0	5.0		5.0	5.0		4.0	4.0	5.0	4.0	4.0	
All-Red Time (s)	2.0	2.0		2.0	2.0		2.0	2.0	2.0	2.0	2.0	
Lost Time Adjust (s)	-1.0	-1.0		-1.0	-1.0			-1.0	-1.0		-1.0	
Total Lost Time (s)	6.0	6.0		6.0	6.0			5.0	6.0		5.0	
Lead/Lag	Lag	Lag		Lead					Lead			
Lead-Lag Optimize?												
Vehicle Extension (s)	3.0	3.0		3.0	3.0		3.0	3.0	3.0	3.0	3.0	
Recall Mode	C-Max	C-Max		None	C-Max		None	None	None	None	None	

Intersection Summary

Area Type: Other
 Cycle Length: 120
 Actuated Cycle Length: 120
 Offset: 5 (4%), Referenced to phase 2:EBTL and 6:WBTL, Start of 1st Green
 Natural Cycle: 90
 Control Type: Actuated-Coordinated

Splits and Phases: 1: Jarrettown Road/Village Road & Welsh Road



1: Jarrettown Road/Village Road & Welsh Road

Movement	EBL	EBT	EBR	WBL	WBT	WBR	NBL	NBT	NEP	SBL	SBT	SBR
Lane Configurations												
Volume (veh/h)	21	799	29	262	980	14	21	20	263	41	91	105
Number	5	2	12	1	6	16	3	8	18	7	4	14
Initial Q (Qb), veh	0	0	0	0	0	0	0	0	0	0	0	0
Ped-Bike Adj(A_pbT)	1.00		1.00	1.00		1.00	1.00		1.00	1.00		1.00
Parking Bus, Adj	1.00	1.00	1.00	1.00	1.00	1.00	1.00	1.00	1.00	1.00	1.00	1.00
Adj Sat Flow, veh/h/ln	1854	1836	1854	1791	1863	1863	1809	1809	1881	1863	1853	1863
Adj Flow Rate, veh/h	22	832	29	273	1021	14	22	21	253	43	95	95
Adj No. of Lanes	1	1	0	1	1	0	0	1	1	0	1	0
Peak Hour Factor	0.96	0.96	0.96	0.96	0.96	0.96	0.96	0.96	0.96	0.96	0.96	0.96
Percent Heavy Veh, %	0	1	1	0	0	0	0	0	0	0	0	0
Cap, veh/h	286	1040	36	363	1339	18	127	108	430	75	130	116
Arrive On Green	0.59	0.59	0.58	0.09	0.73	0.72	0.17	0.18	0.18	0.17	0.18	0.17
Sat Flow, veh/h	570	1764	61	1706	1833	25	457	605	1599	219	732	655
Grp Volume(v), veh/h	22	0	861	273	0	1035	43	0	253	233	0	0
Grp Sat Flow(s),veh/h/ln	570	0	1825	1706	0	1858	1062	0	1599	1605	0	0
Q Serve(g_s), s	2.9	0.0	44.0	6.8	0.0	40.7	0.0	0.0	16.5	11.9	0.0	0.0
Cycle Q Clear(g_c), s	26.2	0.0	44.0	6.8	0.0	40.7	3.0	0.0	16.5	16.8	0.0	0.0
Prop In Lane	1.00		0.03	1.00		0.01	0.51		1.00	0.18		0.41
Lane Grp Cap(c), veh/h	286	0	1076	363	0	1357	225	0	430	308	0	0
V/C Ratio(X)	0.08	0.00	0.80	0.75	0.00	0.76	0.19	0.00	0.59	0.76	0.00	0.00
Avail Cap(c_a), veh/h	286	0	1076	491	0	1357	306	0	519	395	0	0
HCM Platoon Ratio	1.00	1.00	1.00	1.00	1.00	1.00	1.00	1.00	1.00	1.00	1.00	1.00
Upstream Filter(l)	1.00	0.00	1.00	1.00	0.00	1.00	1.00	0.00	1.00	1.00	0.00	0.00
Uniform Delay (d), s/veh	22.8	0.0	19.2	21.4	0.0	9.8	41.8	0.0	38.1	47.6	0.0	0.0
Incr Delay (d2), s/veh	0.5	0.0	6.3	4.4	0.0	4.1	0.4	0.0	1.3	6.2	0.0	0.0
Initial Q Delay(d3),s/veh	0.0	0.0	0.0	0.0	0.0	0.0	0.0	0.0	0.0	0.0	0.0	0.0
%ile BackOfQ(95%),veh/ln	0.9	0.0	31.9	10.0	0.0	29.6	2.3	0.0	11.9	12.8	0.0	0.0
LnGrp Delay(d),s/veh	23.3	0.0	25.4	25.8	0.0	13.9	42.2	0.0	39.4	53.8	0.0	0.0
LnGrp LOS	C		C	C		B	D		D	D		
Approach Vol, veh/h		883			1308			296				233
Approach Delay, s/veh		25.4			16.4			39.8				53.8
Approach LOS		C			B			D				D
Time	1	2	3	4	5	6	7	8				
Assigned Phs	1	2		4		6		8				
Phs Duration (G+Y+Rc), s	16.9	76.7		26.3		93.7		26.3				
Change Period (Y+Rc), s	7.0	7.0		6.0		7.0		6.0				
Max Green Setting (Gmax), s	19.0	54.0		27.0		80.0		27.0				
Max Q Clear Time (g_c+l1), s	9.3	46.0		18.8		42.7		19.0				
Green Ext Time (p_c), s	0.6	7.9		1.4		35.5		1.4				
Intersection Summary												
HCM 2010 Ctrl Delay			25.1									
HCM 2010 LOS			C									

BT Dreshertown, LP
2: Welsh Road & Dresher Road

2018 With PM Peak

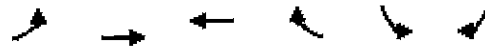

Lane Group	EBL	EBT	WBT	WBR	SEB	SEB
Lane Configurations	↑	↑↑	↑↑	↑	↑↑	↑
Volume (vph)	306	852	907	583	867	413
Ideal Flow (vphpl)	1800	1800	1800	1800	1800	1800
Lane Width (ft)	10	11	11	11	12	13
Grade (%)		-1%	1%		1%	
Storage Length (ft)	225			210	0	415
Storage Lanes	1			1	2	1
Taper Length (ft)	75				75	
Lane Util. Factor	1.00	0.95	0.95	1.00	0.97	1.00
Frt				0.850		0.850
Flt Protected	0.950				0.950	
Satd. Flow (prot)	1588	3257	3257	1457	3268	1558
Flt Permitted	0.120				0.950	
Satd. Flow (perm)	201	3257	3257	1457	3268	1558
Right Turn on Red				Yes		Yes
Satd. Flow (RTOR)				211		25
Link Speed (mph)		45	45		35	
Link Distance (ft)		475	550		970	
Travel Time (s)		7.2	8.3		18.9	
Peak Hour Factor	0.95	0.95	0.95	0.95	0.95	0.95
Heavy Vehicles (%)	1%	2%	1%	1%	1%	1%
Adj. Flow (vph)	322	897	955	614	913	435
Shared Lane Traffic (%)						
Lane Group Flow (vph)	322	897	955	614	913	435
Number of Detectors	1	1	1	1	1	1
Detector Template						
Leading Detector (ft)	35	5	5	5	35	35
Trailing Detector (ft)	-5	0	0	0	-5	-5
Detector 1 Position(ft)	-5	0	0	0	-5	-5
Detector 1 Size(ft)	40	5	5	5	40	40
Detector 1 Type	CI+Ex	CI+Ex	CI+Ex	CI+Ex	CI+Ex	CI+Ex
Detector 1 Channel						
Detector 1 Extend (s)	0.0	0.0	0.0	0.0	0.0	0.0
Detector 1 Queue (s)	0.0	0.0	0.0	0.0	0.0	0.0
Detector 1 Delay (s)	0.0	0.0	0.0	0.0	0.0	0.0
Turn Type	pm+pt	NA	NA	pm+ov	Prot	pm+ov
Protected Phases	5	2	6	4	4	5
Permitted Phases	2			6		4
Detector Phase	5	2	6	4	4	5
Switch Phase						
Minimum Initial (s)	3.0	20.0	20.0	7.0	7.0	3.0
Minimum Split (s)	9.0	26.0	26.0	14.0	14.0	9.0
Total Split (s)	30.0	76.0	46.0	44.0	44.0	30.0
Total Split (%)	25.0%	63.3%	38.3%	36.7%	36.7%	25.0%
Maximum Green (s)	24.0	70.0	40.0	37.0	37.0	24.0
Yellow Time (s)	4.0	4.0	4.0	4.0	4.0	4.0
All-Red Time (s)	2.0	2.0	2.0	3.0	3.0	2.0
Lost Time Adjust (s)	-1.0	-1.0	-1.0	-1.0	-1.0	-1.0
Total Lost Time (s)	5.0	5.0	5.0	6.0	6.0	5.0

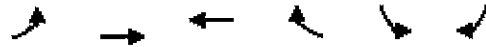

Lane Group	EBL	EBT	WBT	WBR	SBL	SBR
Lead/Lag	Lead		Lag		Lead	
Lead-Lag Optimize?						
Vehicle Extension (s)	3.0	3.0	3.0	3.0	3.0	3.0
Recall Mode	None	C-Max	C-Max	None	None	None
Act Effct Green (s)	71.6	71.6	44.1	86.5	37.4	65.9
Actuated g/C Ratio	0.60	0.60	0.37	0.72	0.31	0.55
v/c Ratio	0.85	0.46	0.80	0.55	0.90	0.50
Control Delay	34.4	17.8	37.5	6.5	51.9	17.6
Queue Delay	0.0	0.1	0.1	0.3	0.0	0.1
Total Delay	34.4	17.9	37.6	6.8	51.9	17.6
LOS	C	B	D	A	D	B
Approach Delay		22.2	25.6		40.8	
Approach LOS		C	C		D	
Queue Length 50th (ft)	170	286	305	132	344	177
Queue Length 95th (ft)	m211	m318	401	203	#456	261
Internal Link Dist (ft)		395	470		890	
Turn Bay Length (ft)	225			210		415
Base Capacity (vph)	408	1943	1196	1115	1034	899
Starvation Cap Reductn	0	0	12	131	0	0
Spillback Cap Reductn	0	215	0	0	0	27
Storage Cap Reductn	0	0	0	0	0	0
Reduced v/c Ratio	0.79	0.52	0.81	0.62	0.88	0.50

Intersection Summary

Area Type: Other
 Cycle Length: 120
 Actuated Cycle Length: 120
 Offset: 77 (64%), Referenced to phase 2:EBTL and 6:WBT, Start of 1st Green
 Natural Cycle: 80
 Control Type: Actuated-Coordinated
 Maximum v/c Ratio: 0.90
 Intersection Signal Delay: 29.6
 Intersection Capacity Utilization 83.8%
 Analysis Period (min) 15
 Intersection LOS: C
 ICU Level of Service E

95th percentile volume exceeds capacity, queue may be longer.
 Queue shown is maximum after two cycles.
 m Volume for 95th percentile queue is metered by upstream signal.

Splits and Phases: 2: Welsh Road & Dresher Road

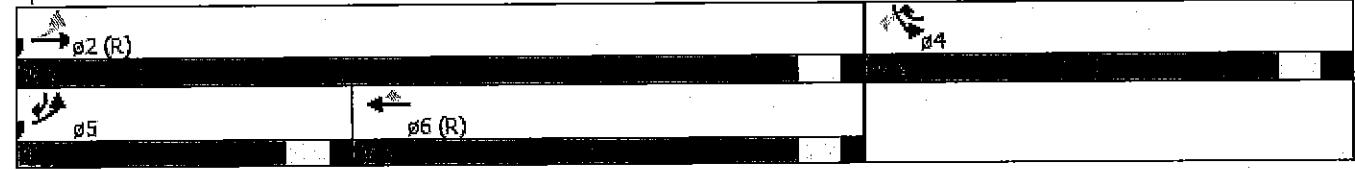

BT Dreshertown, LP
 3: Dreshertown Road & Welsh Road

2018 With PM Peak



Lane Group	EBT	EBR	WBL	WBT	NBL	NBR
Lane Configurations	↑↑	↑	↓	↑↑	↑↓	↑
Volume (vph)	1129	590	468	1072	418	456
Ideal Flow (vphpl)	1800	1800	1800	1800	1800	1800
Lane Width (ft)	11	15	10	12	12	15
Grade (%)	-2%			1%	1%	
Storage Length (ft)		150	175		0	350
Storage Lanes		1	1		2	2
Taper Length (ft)			75		75	
Lane Util. Factor	0.95	1.00	1.00	0.95	0.97	1.00
Frt		0.850				0.850
Flt Protected			0.950		0.950	
Satd. Flow (prot)	3274	1683	1557	3369	3268	1626
Flt Permitted			0.075		0.950	
Satd. Flow (perm)	3274	1683	123	3369	3268	1626
Right Turn on Red		Yes				Yes
Satd. Flow (RTOR)		334				15
Link Speed (mph)	45			45	40	
Link Distance (ft)	550			1040	582	
Travel Time (s)	8.3			15.8	9.9	
Peak Hour Factor	0.96	0.96	0.96	0.96	0.96	0.96
Heavy Vehicles (%)	2%	1%	2%	1%	1%	3%
Adj. Flow (vph)	1176	615	488	1117	435	475
Shared Lane Traffic (%)						
Lane Group Flow (vph)	1176	615	488	1117	435	475
Number of Detectors	1	1	1	1	1	1
Detector Template						
Leading Detector (ft)	5	5	35	5	35	35
Trailing Detector (ft)	0	0	-5	0	-5	-5
Detector 1 Position(ft)	0	0	-5	0	-5	-5
Detector 1 Size(ft)	5	5	40	5	40	40
Detector 1 Type	CI+Ex	CI+Ex	CI+Ex	CI+Ex	CI+Ex	CI+Ex
Detector 1 Channel						
Detector 1 Extend (s)	0.0	0.0	0.0	0.0	0.0	0.0
Detector 1 Queue (s)	0.0	0.0	0.0	0.0	0.0	0.0
Detector 1 Delay (s)	0.0	0.0	0.0	0.0	0.0	0.0
Turn Type	NA	Perm	pm+pt	NA	Prot	pm+ov
Protected Phases	2		1	6	8	1
Permitted Phases		2	6			8
Detector Phase	2	2	1	6	8	1
Switch Phase						
Minimum Initial (s)	20.0	20.0	3.0	20.0	7.0	3.0
Minimum Split (s)	27.0	27.0	10.0	27.0	14.0	10.0
Total Split (s)	51.0	51.0	42.0	93.0	27.0	42.0
Total Split (%)	42.5%	42.5%	35.0%	77.5%	22.5%	35.0%
Maximum Green (s)	44.0	44.0	35.0	86.0	20.0	35.0
Yellow Time (s)	5.0	5.0	5.0	5.0	4.0	5.0
All-Red Time (s)	2.0	2.0	2.0	2.0	3.0	2.0
Lost Time Adjust (s)	-1.0	-1.0	-1.0	-1.0	-1.0	-1.0
Total Lost Time (s)	6.0	6.0	6.0	6.0	6.0	6.0

BT Dreshertown, LP
 3: Dreshertown Road & Welsh Road

2018 With PM Peak



Lane Group	EBT	EBR	WBL	WBTL	NBL	NBR
Lead/Lag	Lag	Lag	Lead			Lead
Lead-Lag Optimize?						
Vehicle Extension (s)	3.0	3.0	3.0	3.0	3.0	3.0
Recall Mode	C-Max	C-Max	None	C-Max	None	None

Intersection Summary

Area Type: Other
 Cycle Length: 120
 Actuated Cycle Length: 120
 Offset: 29 (24%), Referenced to phase 2:EBT and 6:WBTL, Start of 1st Green
 Natural Cycle: 90
 Control Type: Actuated-Coordinated

Splits and Phases: 3: Dreshertown Road & Welsh Road

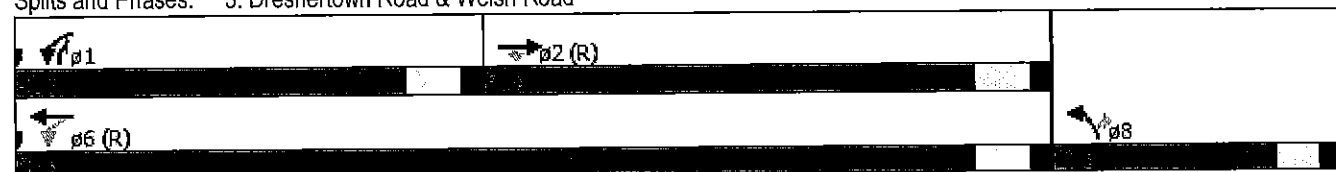

BT Dreshertown, LP
 3: Dreshertown Road & Welsh Road

2018 With PM Peak



Movement	EBT	EBR	WBL	WBT	WBL	WBR
Lane Configurations	↑↑	↑	↓	↑↑	↑↑	↑
Volume (veh/h)	1129	590	468	1072	418	456
Number	2	12	1	6	3	18
Initial Q (Qb), veh	0	0	0	0	0	0
Ped-Bike Adj(A_pbT)		1.00	1.00		1.00	1.00
Parking Bus, Adj	1.00	1.00	1.00	1.00	1.00	1.00
Adj Sat Flow, veh/h/ln	1782	1872	1756	1773	1773	1808
Adj Flow Rate, veh/h	1176	589	488	1117	435	429
Adj No. of Lanes	2	1	1	2	2	1
Peak Hour Factor	0.96	0.96	0.96	0.96	0.96	0.96
Percent Heavy Veh, %	2	1	2	1	1	3
Cap, veh/h	1417	666	514	2443	573	664
Arrive On Green	0.28	0.28	0.51	1.00	0.17	0.17
Sat Flow, veh/h	3476	1591	1672	3458	3276	1537
Grp Volume(v), veh/h	1176	589	488	1117	435	429
Grp Sat Flow(s),veh/h/ln	1693	1591	1672	1685	1638	1537
Q Serve(g_s), s	39.1	42.5	26.3	0.0	15.2	21.0
Cycle Q Clear(g_c), s	39.1	42.5	26.3	0.0	15.2	21.0
Prop In Lane		1.00	1.00		1.00	1.00
Lane Grp Cap(c), veh/h	1417	666	514	2443	573	664
V/C Ratio(X)	0.83	0.88	0.95	0.46	0.76	0.65
Avail Cap(c_a), veh/h	1417	666	587	2443	573	664
HCM Platoon Ratio	0.67	0.67	2.00	2.00	1.00	1.00
Upstream Filter(I)	0.67	0.67	0.81	0.81	1.00	1.00
Uniform Delay (d), s/veh	39.2	40.4	19.2	0.0	47.1	26.9
Incr Delay (d2), s/veh	4.0	11.5	20.5	0.5	5.8	2.2
Initial Q Delay(d3),s/veh	0.0	0.0	0.0	0.0	0.0	0.0
%ile BackOfQ(95%),veh/ln	25.0	27.0	23.8	0.3	11.8	17.2
LnGrp Delay(d),s/veh	43.2	51.9	39.7	0.5	52.9	29.1
LnGrp LOS	D	D	D	A	D	C
Approach Vol, veh/h	1765			1605	864	
Approach Delay, s/veh	46.1			12.4	41.1	
Approach LOS	D			B	D	

Timer	1	2	3	4	5	6	7	8
Assigned Phs	1	2				6		8
Phs Duration (G+Y+Rc), s	36.8	56.2				93.0		27.0
Change Period (Y+Rc), s	7.0	7.0				7.0		7.0
Max Green Setting (Gmax), s	35.0	44.0				86.0		20.0
Max Q Clear Time (g_c+I), s	28.8	45.0				2.5		23.5
Green Ext Time (p_c), s	1.0	0.0				16.4		0.0

Intersection Summary	
HCM 2010 Ctrl Delay	32.3
HCM 2010 LOS	C

BT Dreshertown, LP
4: Dryden Road & Welsh Road

2018 With PM Peak



Lane Group	EBL	EBT	EBR	WBL	WBT	WBR	NBL	NET	NBR	SBL	SBT	SBR
Lane Configurations	↙	↕	↘	↙	↕		↙	↕		↙	↕	↘
Volume (vph)	0	1613	8	11	1437	0	97	8	16	3	0	1
Ideal Flow (vphpl)	1800	1800	1800	1800	1800	1800	1800	1800	1800	1800	1800	1800
Lane Width (ft)	10	12	14	10	12	12	11	15	15	12	14	14
Grade (%)		-1%			-1%			-1%			0%	
Storage Length (ft)	150		225	175		0	110		0	150		0
Storage Lanes	1		1	1		0	1		0	1		0
Taper Length (ft)	75			75			75			75		
Lane Util. Factor	1.00	0.95	1.00	1.00	0.95	0.95	1.00	1.00	1.00	1.00	1.00	1.00
Frt			0.850					0.900			0.850	
Flt Protected				0.950			0.950			0.950		
Satd. Flow (prot)	1688	3403	1640	1604	3370	0	1661	1791	0	1710	1632	0
Flt Permitted				0.118			0.757			0.742		
Satd. Flow (perm)	1688	3403	1640	199	3370	0	1324	1791	0	1336	1632	0
Right Turn on Red			Yes			Yes			Yes			Yes
Satd. Flow (RTOR)			27					16			79	
Link Speed (mph)		45			45			25			25	
Link Distance (ft)		1040			1416			754			960	
Travel Time (s)		15.8			21.5			20.6			26.2	
Peak Hour Factor	0.97	0.97	0.97	0.97	0.97	0.97	0.97	0.97	0.97	0.97	0.97	0.97
Heavy Vehicles (%)	0%	1%	0%	0%	2%	0%	0%	0%	0%	0%	0%	0%
Adj. Flow (vph)	0	1663	8	11	1481	0	100	8	16	3	0	1
Shared Lane Traffic (%)												
Lane Group Flow (vph)	0	1663	8	11	1481	0	100	24	0	3	1	0
Number of Detectors	1	1	1	1	1		1	1		1	1	
Detector Template												
Leading Detector (ft)	5	5	5	5	5		35	35		35	35	
Trailing Detector (ft)	0	0	0	0	0		-5	-5		-5	-5	
Detector 1 Position(ft)	0	0	0	0	0		-5	-5		-5	-5	
Detector 1 Size(ft)	5	5	5	5	5		40	40		40	40	
Detector 1 Type	CI+Ex	CI+Ex	CI+Ex	CI+Ex	CI+Ex		CI+Ex	CI+Ex		CI+Ex	CI+Ex	
Detector 1 Channel												
Detector 1 Extend (s)	0.0	0.0	0.0	0.0	0.0		0.0	0.0		0.0	0.0	
Detector 1 Queue (s)	0.0	0.0	0.0	0.0	0.0		0.0	0.0		0.0	0.0	
Detector 1 Delay (s)	0.0	0.0	0.0	0.0	0.0		0.0	0.0		0.0	0.0	
Turn Type	Perm	NA	Perm	Perm	NA		Perm	NA		Perm	NA	
Protected Phases		2			6			8			4	
Permitted Phases	2		2	6			8			4		
Detector Phase	2	2	2	6	6		8	8		4	4	
Switch Phase												
Minimum Initial (s)	21.0	21.0	21.0	21.0	21.0		5.0	5.0		5.0	5.0	
Minimum Split (s)	27.0	27.0	27.0	27.0	27.0		11.0	11.0		11.0	11.0	
Total Split (s)	95.0	95.0	95.0	95.0	95.0		25.0	25.0		25.0	25.0	
Total Split (%)	79.2%	79.2%	79.2%	79.2%	79.2%		20.8%	20.8%		20.8%	20.8%	
Maximum Green (s)	89.0	89.0	89.0	89.0	89.0		19.0	19.0		19.0	19.0	
Yellow Time (s)	4.0	4.0	4.0	4.0	4.0		3.0	3.0		3.0	3.0	
All-Red Time (s)	2.0	2.0	2.0	2.0	2.0		3.0	3.0		3.0	3.0	
Lost Time Adjust (s)	-1.0	-1.0	-1.0	-1.0	-1.0		-1.0	-1.0		-1.0	-1.0	
Total Lost Time (s)	5.0	5.0	5.0	5.0	5.0		5.0	5.0		5.0	5.0	

BT Dreshertown, LP
 4: Dryden Road & Welsh Road

2018 With PM Peak

























Lane Group	EBL	EBT	EBR	WBL	WBT	WBR	NEL	NBT	NBR	SBL	SBT	SBR
Lead/Lag												
Lead-Lag Optimize?												
Vehicle Extension (s)	3.0	3.0	3.0	3.0	3.0		3.0	3.0		3.0	3.0	
Recall Mode	C-Max	C-Max	C-Max	C-Max	C-Max		None	None		None	None	

Intersection Summary

Area Type: Other
 Cycle Length: 120
 Actuated Cycle Length: 120
 Offset: 59 (49%), Referenced to phase 2:EBTL and 6:WBTL, Start of 1st Green
 Natural Cycle: 50
 Control Type: Actuated-Coordinated

Splits and Phases: 4: Dryden Road & Welsh Road

p2 (R)	p4
p6 (R)	p8

												
Movement	EBL	EBT	EBR	WBL	WBT	WBR	NBL	NBT	NBR	SBL	SBT	SBR
Lane Configurations												
Volume (veh/h)	0	1613	8	11	1437	0	97	8	16	3	0	1
Number	5	2	12	1	6	16	3	8	18	7	4	14
Initial Q (Qb), veh	0	0	0	0	0	0	0	0	0	0	0	0
Ped-Bike Adj(A_pbT)	1.00		1.00	1.00		1.00	1.00		1.00	1.00		1.00
Parking Bus, Adj	1.00	1.00	1.00	1.00	1.00	1.00	1.00	1.00	1.00	1.00	1.00	1.00
Adj Sat Flow, veh/h/ln	1809	1791	1881	1809	1774	1809	1809	1881	1881	1800	1872	1872
Adj Flow Rate, veh/h	0	1663	6	11	1481	0	100	8	16	3	0	1
Adj No. of Lanes	1	2	1	1	2	0	1	1	0	1	1	0
Peak Hour Factor	0.97	0.97	0.97	0.97	0.97	0.97	0.97	0.97	0.97	0.97	0.97	0.97
Percent Heavy Veh, %	0	1	0	0	2	2	0	0	0	0	0	0
Cap, veh/h	60	2790	1311	309	2763	0	200	54	109	184	0	154
Arrive On Green	0.00	1.00	1.00	0.82	0.82	0.00	0.10	0.10	0.09	0.10	0.00	0.09
Sat Flow, veh/h	364	3403	1599	303	3458	0	1446	561	1122	1409	0	1591
Grp Volume(v), veh/h	0	1663	6	11	1481	0	100	0	24	3	0	1
Grp Sat Flow(s),veh/h/ln	364	1702	1599	303	1685	0	1446	0	1683	1409	0	1591
Q Serve(g_s), s	0.0	0.0	0.0	0.8	16.9	0.0	8.1	0.0	1.6	0.2	0.0	0.1
Cycle Q Clear(g_c), s	0.0	0.0	0.0	0.8	16.9	0.0	8.1	0.0	1.6	1.3	0.0	0.1
Prop In Lane	1.00		1.00	1.00		0.00	1.00		0.67	1.00		1.00
Lane Grp Cap(c), veh/h	60	2790	1311	309	2763	0	200	0	163	184	0	154
V/C Ratio(X)	0.00	0.60	0.00	0.04	0.54	0.00	0.50	0.00	0.15	0.02	0.00	0.01
Avail Cap(c_a), veh/h	60	2790	1311	309	2763	0	301	0	281	282	0	265
HCM Platoon Ratio	2.00	2.00	2.00	1.00	1.00	1.00	1.00	1.00	1.00	1.00	1.00	1.00
Upstream Filter(I)	0.00	0.47	0.47	1.00	1.00	0.00	1.00	0.00	1.00	1.00	0.00	1.00
Uniform Delay (d), s/veh	0.0	0.0	0.0	2.0	3.5	0.0	52.6	0.0	50.0	50.0	0.0	49.4
Incr Delay (d2), s/veh	0.0	0.4	0.0	0.2	0.8	0.0	1.9	0.0	0.4	0.0	0.0	0.0
Initial Q Delay(d3),s/veh	0.0	0.0	0.0	0.0	0.0	0.0	0.0	0.0	0.0	0.0	0.0	0.0
%ile BackOfQ(95%),veh/ln	0.0	0.3	0.0	0.2	12.5	0.0	6.0	0.0	1.3	0.2	0.0	0.1
LnGrp Delay(d),s/veh	0.0	0.4	0.0	2.2	4.2	0.0	54.5	0.0	50.4	50.1	0.0	49.5
LnGrp LOS		A	A	A	A		D		D	D		D
Approach Vol, veh/h		1669			1492			124				4
Approach Delay, s/veh		0.4			4.2			53.7				49.9
Approach LOS		A			A			D				D
Timer	1	2	3	4	5	6	7	8				
Assigned Phs		2		4		6		8				
Phs Duration (G+Y+Rc), s		103.4		16.6		103.4		16.6				
Change Period (Y+Rc), s		6.0		6.0		6.0		6.0				
Max Green Setting (Gmax), s		89.0		19.0		89.0		19.0				
Max Q Clear Time (g_c+I1), s		2.5		3.8		19.4		10.6				
Green Ext Time (p_c), s		23.0		0.3		22.2		0.2				
Intersection Summary												
HCM 2010 Ctrl Delay			4.2									
HCM 2010 LOS			A									



Lane Group	WBI	WBR	NBT	NBR	SEB	SEB
Lane Configurations	3	7	867	6	11	1046
Volume (vph)	3	7	867	6	11	1046
Ideal Flow (vphpl)	1800	1800	1800	1800	1800	1800
Grade (%)	0%		1%			0%
Lane Util. Factor	1.00	1.00	1.00	1.00	1.00	1.00
Frt	0.905		0.999			
Flt Protected	0.985					
Satd. Flow (prot)	1573	0	1754	0	0	1765
Flt Permitted	0.985					
Satd. Flow (perm)	1573	0	1754	0	0	1765
Link Speed (mph)	25		40			40
Link Distance (ft)	415		379			582
Travel Time (s)	11.3		6.5			9.9
Peak Hour Factor	0.96	0.96	0.96	0.96	0.96	0.96
Adj. Flow (vph)	3	7	903	6	11	1090
Shared Lane Traffic (%)						
Lane Group Flow (vph)	10	0	909	0	0	1101
Sign Control	Stop		Free			Free

Intersection Summary

Area Type: Other
 Control Type: Unsignalized

Intersection

Int Delay, s/veh 0.2

Movement	WBL	WBR	NBT	NBR	SBT	SBT
Vol, veh/h	3	7	867	6	11	1046
Conflicting Peds, #/hr	0	0	0	0	0	0
Sign Control	Stop	Stop	Free	Free	Free	Free
RT Channelized	-	None	-	None	-	None
Storage Length	0	-	-	-	-	-
Veh in Median Storage, #	0	-	0	-	-	0
Grade, %	0	-	1	-	-	0
Peak Hour Factor	96	96	96	96	96	96
Heavy Vehicles, %	2	2	2	2	2	2
Mvmt Flow	3	7	903	6	11	1090

Major/Minor	Minor1	Minor2	Major1	Major2
Conflicting Flow All	2019	906	0	0
Stage 1	906	-	-	-
Stage 2	1113	-	-	-
Critical Hdwy	6.42	6.22	-	-
Critical Hdwy Stg 1	5.42	-	-	-
Critical Hdwy Stg 2	5.42	-	-	-
Follow-up Hdwy	3	3.1	-	-
Pot Cap-1 Maneuver	68	350	-	-
Stage 1	437	-	-	-
Stage 2	345	-	-	-
Platoon blocked, %	-	-	-	-
Mov Cap-1 Maneuver	65	350	-	-
Mov Cap-2 Maneuver	65	-	-	-
Stage 1	437	-	-	-
Stage 2	328	-	-	-

Approach	WB	NB	SB
HCM Control Delay, s	30.6	0	0.1
HCM LOS	D		

Minor Lane/Major Mvmt	NBT	NBR	WBL	WBR	SBT	SBT
Capacity (veh/h)	-	-	151	578	-	-
HCM Lane V/C Ratio	-	-	0.069	0.02	-	-
HCM Control Delay (s)	-	-	30.6	11.4	0	-
HCM Lane LOS	-	-	D	B	A	-
HCM 95th %file Q(veh)	-	-	0.2	0.1	-	-

1: Jarrettown Road/Village Road & Welsh Road



Lane Group	EBL	EBT	EBR	WBL	WBT	WBR	NBL	NBT	NBR	SBL	SBT	SBR
Lane Configurations	↖	↗		↖	↗		↖	↗	↗		↕	
Volume (vph)	10	605	19	135	565	8	7	2	186	12	2	7
Ideal Flow (vphpl)	1800	1800	1800	1800	1800	1800	1800	1800	1800	1800	1800	1800
Lane Width (ft)	12	12	12	11	14	14	12	12	14	15	15	15
Grade (%)		-6%			1%			-1%			1%	
Storage Length (ft)	150		0	100		0	0		175	0		0
Storage Lanes	1		0	1		0	0		1	0		0
Taper Length (ft)	75			75			75			75		
Lane Util. Factor	1.00	1.00	1.00	1.00	1.00	1.00	1.00	1.00	1.00	1.00	1.00	1.00
Frt		0.995			0.998				0.850		0.953	
Flt Protected	0.950			0.950				0.962			0.973	
Satd. Flow (prot)	1761	1813	0	1612	1907	0	0	1740	1640	0	1827	0
Flt Permitted	0.426			0.309				0.857			0.819	
Satd. Flow (perm)	790	1813	0	524	1907	0	0	1550	1640	0	1538	0
Right Turn on Red			Yes			Yes			Yes			Yes
Satd. Flow (RTOR)		3			2				204		8	
Link Speed (mph)		45			45			35			35	
Link Distance (ft)		1263			605			421			431	
Travel Time (s)		19.1			9.2			8.2			8.4	
Peak Hour Factor	0.91	0.91	0.91	0.91	0.91	0.91	0.91	0.91	0.91	0.91	0.91	0.91
Heavy Vehicles (%)	0%	1%	25%	2%	0%	0%	0%	0%	0%	0%	0%	0%
Adj. Flow (vph)	11	665	21	148	621	9	8	2	204	13	2	8
Shared Lane Traffic (%)												
Lane Group Flow (vph)	11	686	0	148	630	0	0	10	204	0	23	0
Number of Detectors	1	2		1	2		1	1	1	1	1	
Detector Template	Left			Left			Left	Thru	Right	Left	Thru	
Leading Detector (ft)	5	330		35	330		20	35	35	20	35	
Trailing Detector (ft)	0	0		-5	0		0	-5	-5	0	-5	
Detector 1 Position(ft)	0	0		-5	0		0	-5	-5	0	-5	
Detector 1 Size(ft)	5	6		40	6		20	40	40	20	40	
Detector 1 Type	CI+Ex	CI+Ex		CI+Ex	CI+Ex		CI+Ex	CI+Ex	CI+Ex	CI+Ex	CI+Ex	
Detector 1 Channel												
Detector 1 Extend (s)	0.0	0.0		0.0	0.0		0.0	0.0	0.0	0.0	0.0	
Detector 1 Queue (s)	0.0	0.0		0.0	0.0		0.0	0.0	0.0	0.0	0.0	
Detector 1 Delay (s)	0.0	0.0		0.0	0.0		0.0	0.0	0.0	0.0	0.0	
Detector 2 Position(ft)		324			324							
Detector 2 Size(ft)		6			6							
Detector 2 Type		CI+Ex			CI+Ex							
Detector 2 Channel												
Detector 2 Extend (s)		0.0			0.0							
Turn Type	Perm	NA		pm+pt	NA		Perm	NA	pm+ov	Perm	NA	
Protected Phases		2		1	6			8	1		4	
Permitted Phases	2			6			8		8	4		
Detector Phase	2	2		1	6		8	8	1	4	4	
Switch Phase												
Minimum Initial (s)	15.0	15.0		3.0	15.0		7.0	7.0	3.0	7.0	7.0	
Minimum Split (s)	22.0	22.0		10.0	22.0		13.0	13.0	10.0	13.0	13.0	
Total Split (s)	63.0	63.0		19.0	82.0		18.0	18.0	19.0	18.0	18.0	
Total Split (%)	63.0%	63.0%		19.0%	82.0%		18.0%	18.0%	19.0%	18.0%	18.0%	

1: Jarrettown Road/Village Road & Welsh Road

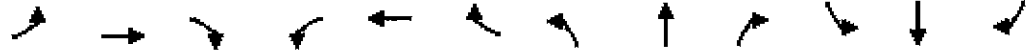

Lane Group	EBL	EBT	EBR	WBL	WBT	WBR	NEL	NBT	NBR	SBL	SBT	SBR
Maximum Green (s)	56.0	56.0		12.0	75.0		12.0	12.0	12.0	12.0	12.0	
Yellow Time (s)	5.0	5.0		5.0	5.0		4.0	4.0	5.0	4.0	4.0	
All-Red Time (s)	2.0	2.0		2.0	2.0		2.0	2.0	2.0	2.0	2.0	
Lost Time Adjust (s)	-1.0	-1.0		-1.0	-1.0			-1.0	-1.0			-1.0
Total Lost Time (s)	6.0	6.0		6.0	6.0			5.0	6.0			5.0
Lead/Lag	Lag	Lag		Lead					Lead			
Lead-Lag Optimize?												
Vehicle Extension (s)	3.0	3.0		3.0	3.0		3.0	3.0	3.0	3.0	3.0	
Recall Mode	C-Max	C-Max		None	C-Max		None	None	None	None	None	

Intersection Summary

Area Type: Other
 Cycle Length: 100
 Actuated Cycle Length: 100
 Offset: 26 (26%), Referenced to phase 2:EBTL and 6:WBTL, Start of 1st Green
 Natural Cycle: 60
 Control Type: Actuated-Coordinated

Splits and Phases: 1: Jarrettown Road/Village Road & Welsh Road

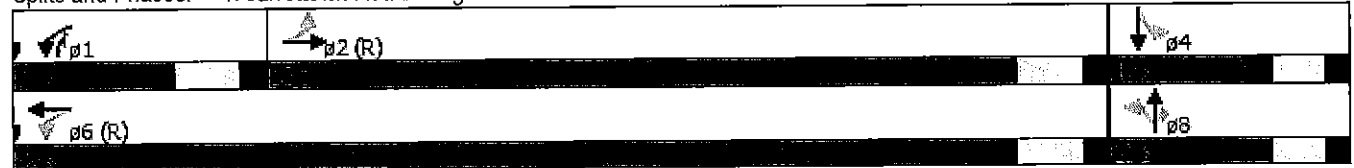

BT Dreshertown, LP
 1: Jarrettown Road/Village Road & Welsh Road

2018 With SAT Peak

Movement	EBL	EBT	EBR	WBL	WBT	WBR	NBL	NBT	NBR	SBL	SBT	SBR
Lane Configurations												
Volume (veh/h)	10	605	19	135	565	8	7	2	186	12	2	7
Number	5	2	12	1	6	16	3	8	18	7	4	14
Initial Q (Qb), veh	0	0	0	0	0	0	0	0	0	0	0	0
Ped-Bike Adj(A_pbT)	1.00		1.00	1.00		1.00	1.00		1.00	1.00		1.00
Parking Bus, Adj	1.00	1.00	1.00	1.00	1.00	1.00	1.00	1.00	1.00	1.00	1.00	1.00
Adj Sat Flow, veh/h/ln	1854	1822	1854	1756	1863	1863	1809	1809	1881	1863	1863	1863
Adj Flow Rate, veh/h	11	665	20	148	621	9	8	2	106	13	2	3
Adj No. of Lanes	1	1	0	1	1	0	0	1	1	0	1	0
Peak Hour Factor	0.91	0.91	0.91	0.91	0.91	0.91	0.91	0.91	0.91	0.91	0.91	0.91
Percent Heavy Veh, %	0	1	1	2	0	0	0	0	0	0	0	0
Cap, veh/h	635	1190	36	535	1457	21	172	37	246	150	27	23
Arrive On Green	0.68	0.68	0.67	0.06	0.80	0.79	0.08	0.09	0.09	0.08	0.09	0.08
Sat Flow, veh/h	833	1760	53	1672	1831	27	1141	392	1599	939	282	244
Grp Volume(v), veh/h	11	0	685	148	0	630	10	0	106	18	0	0
Grp Sat Flow(s),veh/h/ln	833	0	1813	1672	0	1858	1533	0	1599	1464	0	0
Q Serve(g_s), s	0.4	0.0	19.7	2.3	0.0	10.5	0.0	0.0	6.0	0.2	0.0	0.0
Cycle Q Clear(g_c), s	0.4	0.0	19.7	2.3	0.0	10.5	0.5	0.0	6.0	1.0	0.0	0.0
Prop In Lane	1.00		0.03	1.00		0.01	0.80		1.00	0.72		0.17
Lane Grp Cap(c), veh/h	635	0	1226	535	0	1479	194	0	246	185	0	0
V/C Ratio(X)	0.02	0.00	0.56	0.28	0.00	0.43	0.05	0.00	0.43	0.10	0.00	0.00
Avail Cap(c_a), veh/h	635	0	1226	653	0	1479	248	0	303	236	0	0
HCM Platoon Ratio	1.00	1.00	1.00	1.00	1.00	1.00	1.00	1.00	1.00	1.00	1.00	1.00
Upstream Filter(I)	1.00	0.00	1.00	1.00	0.00	1.00	1.00	0.00	1.00	1.00	0.00	0.00
Uniform Delay (d), s/veh	5.3	0.0	8.4	6.1	0.0	3.2	41.6	0.0	38.3	41.9	0.0	0.0
Incr Delay (d2), s/veh	0.0	0.0	1.8	0.3	0.0	0.9	0.1	0.0	1.2	0.2	0.0	0.0
Initial Q Delay(d3),s/veh	0.0	0.0	0.0	0.0	0.0	0.0	0.0	0.0	0.0	0.0	0.0	0.0
%ile BackOfQ(95%),veh/ln	0.2	0.0	15.6	2.0	0.0	9.5	0.5	0.0	4.9	0.9	0.0	0.0
LnGrp Delay(d),s/veh	5.4	0.0	10.3	6.3	0.0	4.1	41.7	0.0	39.5	42.1	0.0	0.0
LnGrp LOS	A		B	A		A	D		D	D		
Approach Vol, veh/h		696			778			116			18	
Approach Delay, s/veh		10.2			4.5			39.7			42.1	
Approach LOS		B			A			D			D	
Timer	1	2	3	4	5	6	7	8				
Assigned Phs	1	2		4		6		8				
Phs Duration (G+Y+Rc), s	12.0	73.6		14.4		85.6		14.4				
Change Period (Y+Rc), s	7.0	7.0		6.0		7.0		6.0				
Max Green Setting (Gmax), s	12.0	56.0		12.0		75.0		12.0				
Max Q Clear Time (g_c+I1), s	4.8	21.7		3.0		12.5		8.5				
Green Ext Time (p_c), s	0.2	26.4		0.3		41.0		0.1				
Intersection Summary												
HCM 2010 Ctrl Delay			9.9									
HCM 2010 LOS			A									

BT Dreshertown, LP
2: Welsh Road & Dresher Road

2018 With SAT Peak



Lane Group	EBL	EBT	WBT	WBR	SBL	SBR
Lane Configurations	↖	↕	↕	↗	↖	↗
Volume (vph)	150	685	601	385	348	144
Ideal Flow (vphpl)	1800	1800	1800	1800	1800	1800
Lane Width (ft)	10	11	11	11	12	13
Grade (%)		-1%	1%		1%	
Storage Length (ft)	225			210	0	415
Storage Lanes	1			1	2	1
Taper Length (ft)	75				75	
Lane Util. Factor	1.00	0.95	0.95	1.00	0.97	1.00
Frt				0.850		0.850
Flt Protected	0.950				0.950	
Satd. Flow (prot)	1573	3290	3257	1472	3301	1542
Flt Permitted	0.336				0.950	
Satd. Flow (perm)	556	3290	3257	1472	3301	1542
Right Turn on Red				Yes		Yes
Satd. Flow (RTOR)				414		129
Link Speed (mph)		45	45		35	
Link Distance (ft)		475	550		970	
Travel Time (s)		7.2	8.3		18.9	
Peak Hour Factor	0.93	0.93	0.93	0.93	0.93	0.93
Heavy Vehicles (%)	2%	1%	1%	0%	0%	2%
Adj. Flow (yph)	161	737	646	414	374	155
Shared Lane Traffic (%)						
Lane Group Flow (vph)	161	737	646	414	374	155
Number of Detectors	1	1	1	1	1	1
Detector Template						
Leading Detector (ft)	35	5	5	5	35	35
Trailing Detector (ft)	-5	0	0	0	-5	-5
Detector 1 Position(ft)	-5	0	0	0	-5	-5
Detector 1 Size(ft)	40	5	5	5	40	40
Detector 1 Type	CI+Ex	CI+Ex	CI+Ex	CI+Ex	CI+Ex	CI+Ex
Detector 1 Channel						
Detector 1 Extend (s)	0.0	0.0	0.0	0.0	0.0	0.0
Detector 1 Queue (s)	0.0	0.0	0.0	0.0	0.0	0.0
Detector 1 Delay (s)	0.0	0.0	0.0	0.0	0.0	0.0
Turn Type	pm+pt	NA	NA	pm+ov	Prot	pm+ov
Protected Phases	5	2	6	4	4	5
Permitted Phases	2			6		4
Detector Phase	5	2	6	4	4	5
Switch Phase						
Minimum Initial (s)	3.0	20.0	20.0	7.0	7.0	3.0
Minimum Split (s)	9.0	26.0	26.0	14.0	14.0	9.0
Total Split (s)	23.0	68.0	45.0	32.0	32.0	23.0
Total Split (%)	23.0%	68.0%	45.0%	32.0%	32.0%	23.0%
Maximum Green (s)	17.0	62.0	39.0	25.0	25.0	17.0
Yellow Time (s)	4.0	4.0	4.0	4.0	4.0	4.0
All-Red Time (s)	2.0	2.0	2.0	3.0	3.0	2.0
Lost Time Adjust (s)	-1.0	-1.0	-1.0	-1.0	-1.0	-1.0
Total Lost Time (s)	5.0	5.0	5.0	6.0	6.0	5.0



Lane Group	EBL	EBT	WBT	WER	SBL	SEB
Lead/Lag	Lead		Lag		Lead	
Lead-Lag Optimize?						
Vehicle Extension (s)	3.0	3.0	3.0	3.0	3.0	3.0
Recall Mode	None	C-Max	C-Max	None	None	None
Act Effct Green (s)	70.3	70.3	55.1	78.8	18.7	34.9
Actuated g/C Ratio	0.70	0.70	0.55	0.79	0.19	0.35
v/c Ratio	0.33	0.32	0.36	0.33	0.61	0.25
Control Delay	6.5	5.5	14.3	2.5	41.2	6.1
Queue Delay	0.0	0.0	0.0	0.0	0.0	0.0
Total Delay	6.5	5.5	14.3	2.5	41.2	6.1
LOS	A	A	B	A	D	A
Approach Delay		5.7	9.7		30.9	
Approach LOS		A	A		C	
Queue Length 50th (ft)	26	65	139	38	113	11
Queue Length 95th (ft)	52	101	159	72	151	46
Internal Link Dist (ft)		395	470		890	
Turn Bay Length (ft)	225			210		415
Base Capacity (vph)	574	2314	1795	1325	858	731
Starvation Cap Reductn	0	0	0	0	0	0
Spillback Cap Reductn	0	0	0	0	0	0
Storage Cap Reductn	0	0	0	0	0	0
Reduced v/c Ratio	0.28	0.32	0.36	0.31	0.44	0.21

Intersection Summary

Area Type: Other
 Cycle Length: 100
 Actuated Cycle Length: 100
 Offset: 38 (38%), Referenced to phase 2:EBTL and 6:WBT, Start of 1st Green
 Natural Cycle: 50
 Control Type: Actuated-Coordinated
 Maximum v/c Ratio: 0.61
 Intersection Signal Delay: 12.8
 Intersection Capacity Utilization 50.1%
 Analysis Period (min) 15
 Intersection LOS: B
 ICU Level of Service A

Splits and Phases: 2: Welsh Road & Dresher Road



BT Dreshertown, LP
3: Dreshertown Road & Welsh Road

2018 With SAT Peak

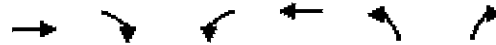

Lane Group	EBT	EBR	WBL	WBT	NBL	NBR
Lane Configurations	↑↑	↑	↓	↑↑	↓↓	↑
Volume (vph)	855	178	254	810	177	302
Ideal Flow (vphpl)	1800	1800	1800	1800	1800	1800
Lane Width (ft)	11	15	10	12	12	15
Grade (%)	-2%			1%	1%	
Storage Length (ft)		150	175		0	350
Storage Lanes		1	1		2	2
Taper Length (ft)			75		75	
Lane Util. Factor	0.95	1.00	1.00	0.95	0.97	1.00
Frt		0.850				0.850
Flt Protected			0.950		0.950	
Satd. Flow (prot)	3339	1683	1588	3403	3301	1675
Flt Permitted			0.227		0.950	
Satd. Flow (perm)	3339	1683	379	3403	3301	1675
Right Turn on Red		Yes				Yes
Satd. Flow (RTOR)		188				76
Link Speed (mph)	45			45	40	
Link Distance (ft)	550			1040	600	
Travel Time (s)	8.3			15.8	10.2	
Peak Hour Factor	0.91	0.91	0.91	0.91	0.91	0.91
Heavy Vehicles (%)	0%	1%	0%	0%	0%	0%
Adj. Flow (vph)	940	196	279	890	195	332
Shared Lane Traffic (%)						
Lane Group Flow (vph)	940	196	279	890	195	332
Number of Detectors	1	1	1	1	1	1
Detector Template						
Leading Detector (ft)	5	5	35	5	35	35
Trailing Detector (ft)	0	0	-5	0	-5	-5
Detector 1 Position(ft)	0	0	-5	0	-5	-5
Detector 1 Size(ft)	5	5	40	5	40	40
Detector 1 Type	CI+Ex	CI+Ex	CI+Ex	CI+Ex	CI+Ex	CI+Ex
Detector 1 Channel						
Detector 1 Extend (s)	0.0	0.0	0.0	0.0	0.0	0.0
Detector 1 Queue (s)	0.0	0.0	0.0	0.0	0.0	0.0
Detector 1 Delay (s)	0.0	0.0	0.0	0.0	0.0	0.0
Turn Type	NA	Perm	pm+pt	NA	Prot	pm+ov
Protected Phases	2		1	6	8	1
Permitted Phases		2	6			8
Detector Phase	2	2	1	6	8	1
Switch Phase						
Minimum Initial (s)	20.0	20.0	3.0	20.0	7.0	3.0
Minimum Split (s)	27.0	27.0	10.0	27.0	14.0	10.0
Total Split (s)	53.0	53.0	29.0	82.0	18.0	29.0
Total Split (%)	53.0%	53.0%	29.0%	82.0%	18.0%	29.0%
Maximum Green (s)	46.0	46.0	22.0	75.0	11.0	22.0
Yellow Time (s)	5.0	5.0	5.0	5.0	4.0	5.0
All-Red Time (s)	2.0	2.0	2.0	2.0	3.0	2.0
Lost Time Adjust (s)	-1.0	-1.0	-1.0	-1.0	-1.0	-1.0
Total Lost Time (s)	6.0	6.0	6.0	6.0	6.0	6.0

BT Dreshertown, LP
 3: Dreshertown Road & Welsh Road

2018 With SAT Peak



Lane Group	EST	EBR	WBI	WBT	NBL	NBR
Lead/Lag	Lag	Lag	Lead			Lead
Lead-Lag Optimize?						
Vehicle Extension (s)	3.0	3.0	3.0	3.0	3.0	3.0
Recall Mode	C-Max	C-Max	None	C-Max	None	None

Intersection Summary

Area Type: Other
 Cycle Length: 100
 Actuated Cycle Length: 100
 Offset: 28 (28%), Referenced to phase 2:EBT and 6:WBTL, Start of 1st Green
 Natural Cycle: 60
 Control Type: Actuated-Coordinated

Splits and Phases: 3: Dreshertown Road & Welsh Road

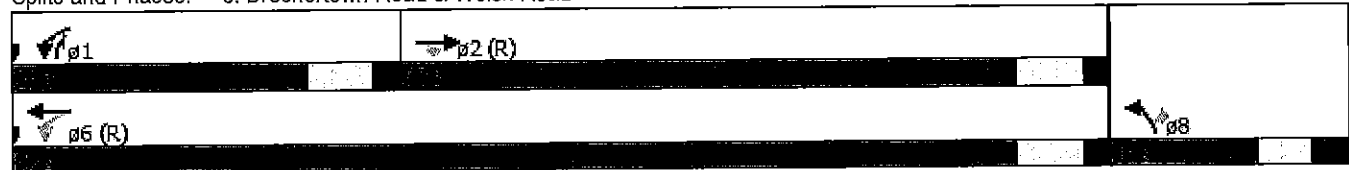

BT Dreshertown, LP
3: Dreshertown Road & Welsh Road

2018 With SAT Peak

	→	↘	↙	←	↗	↖		
Movement	EBT	EBR	WBL	WBT	NBL	NBR		
Lane Configurations	↑↑	↑	↓	↑↑	↑↑	↑		
Volume (veh/h)	855	178	254	810	177	302		
Number	2	12	1	6	3	18		
Initial Q (Qb), veh	0	0	0	0	0	0		
Ped-Bike Adj(A_pbT)		1.00	1.00		1.00	1.00		
Parking Bus, Adj	1.00	1.00	1.00	1.00	1.00	1.00		
Adj Sat Flow, veh/h/ln	1818	1872	1791	1791	1791	1863		
Adj Flow Rate, veh/h	940	196	279	890	195	246		
Adj No. of Lanes	2	1	1	2	2	1		
Peak Hour Factor	0.91	0.91	0.91	0.91	0.91	0.91		
Percent Heavy Veh, %	0	1	0	0	0	0		
Cap, veh/h	2067	952	545	2586	397	351		
Arrive On Green	1.00	1.00	0.20	1.00	0.12	0.12		
Sat Flow, veh/h	3545	1591	1706	3492	3309	1583		
Grp Volume(v), veh/h	940	196	279	890	195	246		
Grp Sat Flow(s),veh/h/ln	1727	1591	1706	1701	1655	1583		
Q Serve(g_s), s	0.0	0.0	5.9	0.0	5.5	12.0		
Cycle Q Clear(g_c), s	0.0	0.0	5.9	0.0	5.5	12.0		
Prop In Lane		1.00	1.00		1.00	1.00		
Lane Grp Cap(c), veh/h	2067	952	545	2586	397	351		
V/C Ratio(X)	0.45	0.21	0.51	0.34	0.49	0.70		
Avail Cap(c_a), veh/h	2067	952	764	2586	397	351		
HCM Platoon Ratio	2.00	2.00	2.00	2.00	1.00	1.00		
Upstream Filter(I)	0.91	0.91	0.94	0.94	1.00	1.00		
Uniform Delay (d), s/veh	0.0	0.0	4.1	0.0	41.1	35.9		
Incr Delay (d2), s/veh	0.7	0.4	0.7	0.3	0.9	6.1		
Initial Q Delay(d3),s/veh	0.0	0.0	0.0	0.0	0.0	0.0		
%ile BackOfQ(95%),veh/ln	0.3	0.2	4.9	0.2	4.6	11.2		
LnGrp Delay(d),s/veh	0.7	0.4	4.8	0.3	42.1	42.0		
LnGrp LOS	A	A	A	A	D	D		
Approach Vol, veh/h	1136			1169	441			
Approach Delay, s/veh	0.6			1.4	42.0			
Approach LOS	A			A	D			
Turner	1	2	3	4	5	6	7	8
Assigned Phs	1	2				6		8
Phs Duration (G+Y+Rc), s	16.2	65.8				82.0		18.0
Change Period (Y+Rc), s	7.0	7.0				7.0		7.0
Max Green Setting (Gmax), s	22.0	46.0				75.0		11.0
Max Q Clear Time (g_c+I1), s	8.4	2.5				2.5		14.5
Green Ext Time (p_c), s	0.7	8.0				8.2		0.0
Intersection Summary								
HCM 2010 Ctrl Delay			7.6					
HCM 2010 LOS			A					

BT Dreshertown, LP
4: Dryden Road & Welsh Road

2018 With SAT Peak



Lane Group	EBL	EBT	EBR	WBL	WBT	WBR	NBL	NBT	NBR	SEB	SEB	SBR
Lane Configurations	↙	↑↑	↗	↙	↑↑		↙	↑		↙	↑	
Volume (vph)	2	1095	4	6	1074	2	2	0	6	2	0	2
Ideal Flow (vphpl)	1800	1800	1800	1800	1800	1800	1800	1800	1800	1800	1800	1800
Lane Width (ft)	10	12	14	10	12	12	11	15	15	12	14	14
Grade (%)		-1%			-1%			-1%			0%	
Storage Length (ft)	150		225	175		0	110		0	150		0
Storage Lanes	1		1	1		0	1		0	1		0
Taper Length (ft)	75			75			75			75		
Lane Util. Factor	1.00	0.95	1.00	1.00	0.95	0.95	1.00	1.00	1.00	1.00	1.00	1.00
Frnt			0.850					0.850			0.850	
Flt Protected	0.950			0.950			0.950			0.950		
Satd. Flow (prot)	1604	3437	1640	1604	3437	0	1661	1691	0	1710	1632	0
Flt Permitted	0.232			0.226								
Satd. Flow (perm)	392	3437	1640	382	3437	0	1749	1691	0	1800	1632	0
Right Turn on Red			Yes			Yes			Yes			Yes
Satd. Flow (RTOR)			33		1			147			153	
Link Speed (mph)		45			45			25			25	
Link Distance (ft)		1040			1416			754			960	
Travel Time (s)		15.8			21.5			20.6			26.2	
Peak Hour Factor	0.90	0.90	0.90	0.90	0.90	0.90	0.90	0.90	0.90	0.90	0.90	0.90
Heavy Vehicles (%)	0%	0%	0%	0%	0%	0%	0%	0%	0%	0%	0%	0%
Adj. Flow (vph)	2	1217	4	7	1193	2	2	0	7	2	0	2
Shared Lane Traffic (%)												
Lane Group Flow (vph)	2	1217	4	7	1195	0	2	7	0	2	2	0
Number of Detectors	1	1	1	1	1		1	1		1	1	
Detector Template												
Leading Detector (ft)	5	5	5	5	5		35	35		35	35	
Trailing Detector (ft)	0	0	0	0	0		-5	-5		-5	-5	
Detector 1 Position(ft)	0	0	0	0	0		-5	-5		-5	-5	
Detector 1 Size(ft)	5	5	5	5	5		40	40		40	40	
Detector 1 Type	CI+Ex	CI+Ex	CI+Ex	CI+Ex	CI+Ex		CI+Ex	CI+Ex		CI+Ex	CI+Ex	
Detector 1 Channel												
Detector 1 Extend (s)	0.0	0.0	0.0	0.0	0.0		0.0	0.0		0.0	0.0	
Detector 1 Queue (s)	0.0	0.0	0.0	0.0	0.0		0.0	0.0		0.0	0.0	
Detector 1 Delay (s)	0.0	0.0	0.0	0.0	0.0		0.0	0.0		0.0	0.0	
Turn Type	Perm	NA	Perm	Perm	NA		Perm	NA		Perm	NA	
Protected Phases		2			6			8			4	
Permitted Phases	2		2	6			8			4		
Detector Phase	2	2	2	6	6		8	8		4	4	
Switch Phase												
Minimum Initial (s)	21.0	21.0	21.0	21.0	21.0		5.0	5.0		5.0	5.0	
Minimum Split (s)	27.0	27.0	27.0	27.0	27.0		11.0	11.0		11.0	11.0	
Total Split (s)	85.0	85.0	85.0	85.0	85.0		15.0	15.0		15.0	15.0	
Total Split (%)	85.0%	85.0%	85.0%	85.0%	85.0%		15.0%	15.0%		15.0%	15.0%	
Maximum Green (s)	79.0	79.0	79.0	79.0	79.0		9.0	9.0		9.0	9.0	
Yellow Time (s)	4.0	4.0	4.0	4.0	4.0		3.0	3.0		3.0	3.0	
All-Red Time (s)	2.0	2.0	2.0	2.0	2.0		3.0	3.0		3.0	3.0	
Lost Time Adjust (s)	-1.0	-1.0	-1.0	-1.0	-1.0		-1.0	-1.0		-1.0	-1.0	
Total Lost Time (s)	5.0	5.0	5.0	5.0	5.0		5.0	5.0		5.0	5.0	

BT Dreshertown, LP
 4: Dryden Road & Welsh Road

2018 With SAT Peak



Lane Group	EBL	EBT	EBR	WBL	WBT	WBR	NBL	NBT	NBR	SBL	SBT	SBR
Lead/Lag												
Lead-Lag Optimize?												
Vehicle Extension (s)	3.0	3.0	3.0	3.0	3.0		3.0	3.0		3.0	3.0	
Recall Mode	C-Max	C-Max	C-Max	C-Max	C-Max		None	None		None	None	

Intersection Summary

Area Type: Other
 Cycle Length: 100
 Actuated Cycle Length: 100
 Offset: 41 (41%), Referenced to phase 2:EBTL and 6:WBTL, Start of 1st Green
 Natural Cycle: 40
 Control Type: Actuated-Coordinated

Splits and Phases: 4: Dryden Road & Welsh Road

p2 (R)	p4
p5 (L)	p8

BT Dreshertown, LP
4: Dryden Road & Welsh Road

2018 With SAT Peak

Movement	EBL	EBT	EBR	WBL	WBT	WBR	NBL	NBT	NBR	SBL	SBT	SBR
Lane Configurations												
Volume (veh/h)	2	1095	4	6	1074	2	2	0	6	2	0	2
Number	5	2	12	1	6	16	3	8	18	7	4	14
Initial Q (Qb), veh	0	0	0	0	0	0	0	0	0	0	0	0
Ped-Bike Adj(A_pbT)	1.00		1.00	1.00		1.00	1.00		1.00	1.00		1.00
Parking Bus, Adj	1.00	1.00	1.00	1.00	1.00	1.00	1.00	1.00	1.00	1.00	1.00	1.00
Adj Sat Flow, veh/h/ln	1809	1809	1881	1809	1809	1809	1809	1881	1881	1800	1872	1872
Adj Flow Rate, veh/h	2	1217	2	7	1193	2	2	0	7	2	0	2
Adj No. of Lanes	1	2	1	1	2	0	1	1	0	1	1	0
Peak Hour Factor	0.90	0.90	0.90	0.90	0.90	0.90	0.90	0.90	0.90	0.90	0.90	0.90
Percent Heavy Veh, %	0	0	0	0	0	0	0	0	0	0	0	0
Cap, veh/h	460	3007	1399	481	3080	5	108	0	40	108	0	40
Arrive On Green	1.00	1.00	1.00	0.87	0.87	0.86	0.03	0.00	0.02	0.03	0.00	0.02
Sat Flow, veh/h	478	3437	1599	467	3521	6	1445	0	1599	1431	0	1591
Grp Volume(v), veh/h	2	1217	2	7	582	613	2	0	7	2	0	2
Grp Sat Flow(s),veh/h/ln	478	1719	1599	467	1719	1808	1445	0	1599	1431	0	1591
Q Serve(g_s), s	0.0	0.0	0.0	0.2	6.4	6.4	0.1	0.0	0.4	0.1	0.0	0.1
Cycle Q Clear(g_c), s	6.4	0.0	0.0	0.2	6.4	6.4	0.1	0.0	0.4	0.1	0.0	0.1
Prop In Lane	1.00		1.00	1.00		0.00	1.00		1.00	1.00		1.00
Lane Grp Cap(c), veh/h	460	3007	1399	481	1503	1582	108	0	40	108	0	40
V/C Ratio(X)	0.00	0.40	0.00	0.01	0.39	0.39	0.02	0.00	0.17	0.02	0.00	0.05
Avail Cap(c_a), veh/h	460	3007	1399	481	1503	1582	216	0	160	215	0	159
HCM Platoon Ratio	2.00	2.00	2.00	1.00	1.00	1.00	1.00	1.00	1.00	1.00	1.00	1.00
Upstream Filter(I)	0.85	0.85	0.85	1.00	1.00	1.00	1.00	0.00	1.00	1.00	0.00	1.00
Uniform Delay (d), s/veh	0.2	0.0	0.0	0.8	1.2	1.2	47.6	0.0	48.2	47.6	0.0	48.1
Incr Delay (d2), s/veh	0.0	0.3	0.0	0.1	0.8	0.7	0.1	0.0	2.0	0.1	0.0	0.5
Initial Q Delay(d3),s/veh	0.0	0.0	0.0	0.0	0.0	0.0	0.0	0.0	0.0	0.0	0.0	0.0
%ile BackOfQ(95%),veh/ln	0.0	0.3	0.0	0.1	5.8	6.1	0.1	0.0	0.4	0.1	0.0	0.1
LnGrp Delay(d),s/veh	0.3	0.3	0.0	0.9	1.9	1.9	47.6	0.0	50.2	47.7	0.0	48.6
LnGrp LOS	A	A	A	A	A	A	D		D	D		D
Approach Vol, veh/h		1221			1202			9			4	
Approach Delay, s/veh		0.3			1.9			49.7			48.1	
Approach LOS		A			A			D			D	
Turns	1	2	3	4	5	6	7	8				
Assigned Phs		2		4		6		8				
Phs Duration (G+Y+Rc), s		92.5		7.5		92.5		7.5				
Change Period (Y+Rc), s		6.0		6.0		6.0		6.0				
Max Green Setting (Gmax), s		79.0		9.0		79.0		9.0				
Max Q Clear Time (g_c+I1), s		8.9		2.6		8.9		2.6				
Green Ext Time (p_c), s		10.3		0.0		10.3		0.0				
Intersection Summary												
HCM 2010 Ctrl Delay			1.4									
HCM 2010 LOS			A									



Lane Group	WBL	WBR	NBT	NBR	SBI	SBT
Lane Configurations	↔		↑			↕
Volume (vph)	3	5	474	2	4	428
Ideal Flow (vphpl)	1800	1800	1800	1800	1800	1800
Grade (%)	0%		1%			0%
Lane Util. Factor	1.00	1.00	1.00	1.00	1.00	1.00
Frt	0.916		0.999			
Fit Protected	0.982					
Satd. Flow (prot)	1587	0	1789	0	0	1800
Fit Permitted	0.982					
Satd. Flow (perm)	1587	0	1789	0	0	1800
Link Speed (mph)	25		40			40
Link Distance (ft)	431		648			600
Travel Time (s)	11.8		11.0			10.2
Peak Hour Factor	0.91	0.91	0.91	0.91	0.91	0.91
Heavy Vehicles (%)	2%	2%	0%	2%	2%	0%
Adj. Flow (vph)	3	5	521	2	4	470
Shared Lane Traffic (%)						
Lane Group Flow (vph)	8	0	523	0	0	474
Sign Control	Stop		Free			Free

Intersection Summary

Area Type: Other
 Control Type: Unsignalized

Intersection

Int Delay, s/veh 0.2

Movement	WBI	WER	NBT	NBR	SBL	SBT
Vol, veh/h	3	5	474	2	4	428
Conflicting Peds, #/hr	0	0	0	0	0	0
Sign Control	Stop	Stop	Free	Free	Free	Free
RT Channelized	-	None	-	None	-	None
Storage Length	0	-	-	-	-	-
Veh in Median Storage, #	0	-	0	-	-	0
Grade, %	0	-	1	-	-	0
Peak Hour Factor	91	91	91	91	91	91
Heavy Vehicles, %	2	2	0	2	2	0
Mvmt Flow	3	5	521	2	4	470

Major/Minor	Minor1	Minor2	Major1	Major2
Conflicting Flow All	1001	522	0	0
Stage 1	522	-	-	-
Stage 2	479	-	-	-
Critical Hdwy	6.42	6.22	-	-
Critical Hdwy Stg 1	5.42	-	-	-
Critical Hdwy Stg 2	5.42	-	-	-
Follow-up Hdwy	3	3.1	-	-
Pot Cap-1 Maneuver	297	585	-	-
Stage 1	674	-	-	-
Stage 2	708	-	-	-
Platoon blocked, %	-	-	-	-
Mov Cap-1 Maneuver	295	585	-	-
Mov Cap-2 Maneuver	295	-	-	-
Stage 1	674	-	-	-
Stage 2	703	-	-	-

Approach	WB	NB	SB
HCM Control Delay, s	13.6	0	0.1
HCM LOS	B		

Minor Lane/Major Mvmt	NB1	NBR	WBLa1	SBL	SBT
Capacity (veh/h)	-	-	427	793	-
HCM Lane V/C Ratio	-	-	0.021	0.006	-
HCM Control Delay (s)	-	-	13.6	9.6	0
HCM Lane LOS	-	-	B	A	A
HCM 95th %tile Q(veh)	-	-	0.1	0	-

APPENDIX J

**2023 Future without Development
Capacity/Level-of-Service Analysis Worksheets**

BT Dreshertown, LP
1: Jarretstown Road/Village Road & Welsh Road

2023 Without AM Peak



Lane Group	EBL	EBT	EBR	WBL	WBT	WBR	NBL	NBT	NBR	SBL	SBT	SBR
Lane Configurations	↖	↗		↖	↗			↖	↗		↕	
Volume (vph)	58	898	19	294	694	8	19	61	345	9	20	28
Ideal Flow (vphpl)	1800	1800	1800	1800	1800	1800	1800	1800	1800	1800	1800	1800
Lane Width (ft)	12	12	12	11	14	14	12	12	14	15	15	15
Grade (%)		-6%			1%			-1%			1%	
Storage Length (ft)	150		0	100		0	0		175	0		0
Storage Lanes	1		0	1		0	0		1	0		0
Taper Length (ft)	75			75			75			75		
Lane Util. Factor	1.00	1.00	1.00	1.00	1.00	1.00	1.00	1.00	1.00	1.00	1.00	1.00
Frnt		0.997			0.998				0.850		0.934	
Flt Protected	0.950			0.950				0.988			0.992	
Satd. Flow (prot)	1727	1810	0	1612	1852	0	0	1760	1640	0	1736	0
Flt Permitted	0.385			0.064				0.918			0.940	
Satd. Flow (perm)	700	1810	0	109	1852	0	0	1636	1640	0	1645	0
Right Turn on Red			Yes			Yes			Yes			Yes
Satd. Flow (RTOR)		1			1				84			29
Link Speed (mph)		45			45			35				35
Link Distance (ft)		1263			605			421				431
Travel Time (s)		19.1			9.2			8.2				8.4
Peak Hour Factor	0.95	0.95	0.95	0.95	0.95	0.95	0.95	0.95	0.95	0.95	0.95	0.95
Heavy Vehicles (%)	2%	2%	7%	2%	3%	0%	0%	2%	0%	11%	0%	7%
Adj. Flow (vph)	61	945	20	309	731	8	20	64	363	9	21	29
Shared Lane Traffic (%)												
Lane Group Flow (vph)	61	965	0	309	739	0	0	84	363	0	59	0
Number of Detectors	1	2		1	2		1	1	1	1	1	
Detector Template	Left			Left			Left	Thru	Right	Left	Thru	
Leading Detector (ft)	5	330		35	330		20	35	35	20	35	
Trailing Detector (ft)	0	0		-5	0		0	-5	-5	0	-5	
Detector 1 Position (ft)	0	0		-5	0		0	-5	-5	0	-5	
Detector 1 Size (ft)	5	6		40	6		20	40	40	20	40	
Detector 1 Type	CI+Ex	CI+Ex		CI+Ex	CI+Ex		CI+Ex	CI+Ex	CI+Ex	CI+Ex	CI+Ex	
Detector 1 Channel												
Detector 1 Extend (s)	0.0	0.0		0.0	0.0		0.0	0.0	0.0	0.0	0.0	
Detector 1 Queue (s)	0.0	0.0		0.0	0.0		0.0	0.0	0.0	0.0	0.0	
Detector 1 Delay (s)	0.0	0.0		0.0	0.0		0.0	0.0	0.0	0.0	0.0	
Detector 2 Position (ft)		324			324							
Detector 2 Size (ft)		6			6							
Detector 2 Type		CI+Ex			CI+Ex							
Detector 2 Channel												
Detector 2 Extend (s)		0.0			0.0							
Turn Type	Perm	NA		pm+pt	NA		Perm	NA	pm+ov	Perm	NA	
Protected Phases		2		1	6			8	1		4	
Permitted Phases	2			6			8		8	4		
Detector Phase	2	2		1	6		8	8	1	4	4	
Switch Phase												
Minimum Initial (s)	15.0	15.0		3.0	15.0		7.0	7.0	3.0	7.0	7.0	
Minimum Split (s)	22.0	22.0		10.0	22.0		13.0	13.0	10.0	13.0	13.0	
Total Split (s)	65.0	65.0		32.0	97.0		23.0	23.0	32.0	23.0	23.0	
Total Split (%)	54.2%	54.2%		26.7%	80.8%		19.2%	19.2%	26.7%	19.2%	19.2%	

BT Dreshertown, LP
 1: Jarrettown Road/Village Road & Welsh Road

2023 Without AM Peak



Lane Group	EBL	EBT	EBR	WBL	WBT	WBR	NBL	NBT	NBR	SEB	SEB	SBR
Maximum Green (s)	58.0	58.0		25.0	90.0		17.0	17.0	25.0	17.0	17.0	
Yellow Time (s)	5.0	5.0		5.0	5.0		4.0	4.0	5.0	4.0	4.0	
All-Red Time (s)	2.0	2.0		2.0	2.0		2.0	2.0	2.0	2.0	2.0	
Lost Time Adjust (s)	-1.0	-1.0		-1.0	-1.0			-1.0	-1.0		-1.0	
Total Lost Time (s)	6.0	6.0		6.0	6.0			5.0	6.0		5.0	
Lead/Lag	Lag	Lag		Lead					Lead			
Lead-Lag Optimize?												
Vehicle Extension (s)	3.0	3.0		3.0	3.0		3.0	3.0	3.0	3.0	3.0	
Recall Mode	C-Max	C-Max		None	C-Max		None	None	None	None	None	

Intersection Summary

Area Type: Other
 Cycle Length: 120
 Actuated Cycle Length: 120
 Offset: 33 (28%), Referenced to phase 2:EBTL and 6:WBTL, Start of 1st Green
 Natural Cycle: 90
 Control Type: Actuated-Coordinated

Splits and Phases: 1: Jarrettown Road/Village Road & Welsh Road





Movement	EBL	EBT	EBR	WBL	WBT	WBR	NBL	NBT	NBR	SBL	SBT	SBR
Lane Configurations	↖	↗		↖	↗			↖	↗		↕	
Volume (veh/h)	58	898	19	294	694	8	19	61	345	9	20	28
Number	5	2	12	1	6	16	3	8	18	7	4	14
Initial Q (Qb), veh	0	0	0	0	0	0	0	0	0	0	0	0
Ped-Bike Adj(A_pbT)	1.00		1.00	1.00		1.00	1.00		1.00	1.00		1.00
Parking Bus, Adj	1.00	1.00	1.00	1.00	1.00	1.00	1.00	1.00	1.00	1.00	1.00	1.00
Adj Sat Flow, veh/h/ln	1818	1816	1854	1756	1809	1863	1809	1782	1881	1863	1772	1863
Adj Flow Rate, veh/h	61	945	18	309	731	7	20	64	336	9	21	27
Adj No. of Lanes	1	1	0	1	1	0	0	1	1	0	1	0
Peak Hour Factor	0.95	0.95	0.95	0.95	0.95	0.95	0.95	0.95	0.95	0.95	0.95	0.95
Percent Heavy Veh, %	2	2	2	2	3	3	2	2	0	0	0	0
Cap, veh/h	457	955	18	355	1357	13	76	216	513	53	104	110
Arrive On Green	0.54	0.54	0.53	0.17	0.76	0.75	0.14	0.15	0.15	0.14	0.15	0.14
Sat Flow, veh/h	739	1776	34	1672	1789	17	261	1441	1599	120	694	733
Grp Volume(v), veh/h	61	0	963	309	0	738	84	0	336	57	0	0
Grp Sat Flow(s), veh/h/ln	739	0	1810	1672	0	1806	1702	0	1599	1547	0	0
Q Serve(g_s), s	5.0	0.0	63.1	16.4	0.0	20.0	0.0	0.0	18.0	0.0	0.0	0.0
Cycle Q Clear(g_c), s	5.0	0.0	63.1	16.4	0.0	20.0	5.1	0.0	18.0	3.7	0.0	0.0
Prop In Lane	1.00		0.02	1.00		0.01	0.24		1.00	0.16		0.47
Lane Grp Cap(c), veh/h	457	0	973	355	0	1370	278	0	513	254	0	0
V/C Ratio(X)	0.13	0.00	0.99	0.87	0.00	0.54	0.30	0.00	0.66	0.22	0.00	0.00
Avail Cap(c_a), veh/h	457	0	973	432	0	1370	278	0	513	254	0	0
HCM Platoon Ratio	1.00	1.00	1.00	1.00	1.00	1.00	1.00	1.00	1.00	1.00	1.00	1.00
Upstream Filter(I)	1.00	0.00	1.00	1.00	0.00	1.00	1.00	0.00	1.00	1.00	0.00	0.00
Uniform Delay (d), s/veh	14.0	0.0	27.4	38.9	0.0	5.9	45.6	0.0	35.1	45.2	0.0	0.0
Incr Delay (d2), s/veh	0.6	0.0	26.4	15.1	0.0	1.5	0.6	0.0	3.0	0.4	0.0	0.0
Initial Q Delay(d3),s/veh	0.0	0.0	0.0	0.0	0.0	0.0	0.0	0.0	0.0	0.0	0.0	0.0
%ile BackOfQ(95%),veh/ln	2.0	0.0	48.6	16.9	0.0	15.7	4.6	0.0	15.2	3.1	0.0	0.0
LnGrp Delay(d),s/veh	14.6	0.0	53.8	54.0	0.0	7.5	46.2	0.0	38.1	45.6	0.0	0.0
LnGrp LOS	B		D	D		A	D		D	D		
Approach Vol, veh/h		1024			1047			420			57	
Approach Delay, s/veh		51.5			21.2			39.7			45.6	
Approach LOS		D			C			D			D	

Phs	1	2	3	4	5	6	7	8
Assigned Phs	1	2		4		6		8
Phs Duration (G+Y+Rc), s	26.5	70.5		23.0		97.0		23.0
Change Period (Y+Rc), s	7.0	7.0		6.0		7.0		6.0
Max Green Setting (Gmax), s	25.0	58.0		17.0		90.0		17.0
Max Q Clear Time (g_c+1), s	18.9	65.1		5.7		22.0		20.5
Green Ext Time (p_c), s	0.5	0.0		1.5		58.5		0.0

Intersection Summary	
HCM 2010 Ctrl Delay	37.0
HCM 2010 LOS	D



Lane Group	EBL	EBT	WBT	WBR	SBL	SBR
Lane Configurations	↶	↷	↷	↷	↶	↷
Volume (vph)	426	857	727	612	696	320
Ideal Flow (vphpl)	1800	1800	1800	1800	1800	1800
Lane Width (ft)	10	11	11	11	12	13
Grade (%)		-1%	1%		1%	
Storage Length (ft)	225			210	0	415
Storage Lanes	1			1	2	1
Taper Length (ft)	75				75	
Lane Util. Factor	1.00	0.95	0.95	1.00	0.97	1.00
Frt				0.850		0.850
Flt Protected	0.950				0.950	
Satd. Flow (prot)	1588	3290	3194	1443	3268	1542
Flt Permitted	0.186				0.950	
Satd. Flow (perm)	311	3290	3194	1443	3268	1542
Right Turn on Red				Yes		Yes
Satd. Flow (RTOR)				211		37
Link Speed (mph)		45	45		35	
Link Distance (ft)		475	550		970	
Travel Time (s)		7.2	8.3		18.9	
Peak Hour Factor	0.94	0.94	0.94	0.94	0.94	0.94
Heavy Vehicles (%)	1%	1%	3%	2%	1%	2%
Adj. Flow (vph)	453	912	773	651	740	340
Shared Lane Traffic (%)						
Lane Group Flow (vph)	453	912	773	651	740	340
Number of Detectors	1	1	1	1	1	1
Detector Template						
Leading Detector (ft)	35	5	5	5	35	35
Trailing Detector (ft)	-5	0	0	0	-5	-5
Detector 1 Position(ft)	-5	0	0	0	-5	-5
Detector 1 Size(ft)	40	5	5	5	40	40
Detector 1 Type	CI+Ex	CI+Ex	CI+Ex	CI+Ex	CI+Ex	CI+Ex
Detector 1 Channel						
Detector 1 Extend (s)	0.0	0.0	0.0	0.0	0.0	0.0
Detector 1 Queue (s)	0.0	0.0	0.0	0.0	0.0	0.0
Detector 1 Delay (s)	0.0	0.0	0.0	0.0	0.0	0.0
Turn Type	pm+pt	NA	NA	pm+ov	Prot	pm+ov
Protected Phases	5	2	6	4	4	5
Permitted Phases	2			6		4
Detector Phase	5	2	6	4	4	5
Switch Phase						
Minimum Initial (s)	3.0	20.0	20.0	7.0	7.0	3.0
Minimum Split (s)	9.0	26.0	26.0	14.0	14.0	9.0
Total Split (s)	40.0	82.0	42.0	38.0	38.0	40.0
Total Split (%)	33.3%	68.3%	35.0%	31.7%	31.7%	33.3%
Maximum Green (s)	34.0	76.0	36.0	31.0	31.0	34.0
Yellow Time (s)	4.0	4.0	4.0	4.0	4.0	4.0
All-Red Time (s)	2.0	2.0	2.0	3.0	3.0	2.0
Lost Time Adjust (s)	-1.0	-1.0	-1.0	-1.0	-1.0	-1.0
Total Lost Time (s)	5.0	5.0	5.0	6.0	6.0	5.0



Lane Group	EBL	EBT	WBT	WBR	SBL	SBR
Lead/Lag	Lead		Lag		Lead	
Lead-Lag Optimize?						
Vehicle Extension (s)	3.0	3.0	3.0	3.0	3.0	3.0
Recall Mode	None	C-Max	C-Max	None	None	None
Act Effct Green (s)	77.7	77.7	42.1	78.5	31.3	67.9
Actuated g/C Ratio	0.65	0.65	0.35	0.65	0.26	0.57
v/c Ratio	0.86	0.43	0.69	0.64	0.87	0.38
Control Delay	29.2	6.3	39.7	15.4	54.2	13.3
Queue Delay	0.0	0.1	0.0	0.4	0.0	0.0
Total Delay	29.2	6.4	39.7	15.9	54.2	13.3
LOS	C	A	D	B	D	B
Approach Delay	13.9		28.8		41.4	
Approach LOS	B		C		D	
Queue Length 50th (ft)	180	83	298	237	280	111
Queue Length 95th (ft)	m243	m101	376	406	#374	167
Internal Link Dist (ft)	395		470		890	
Turn Bay Length (ft)	225		210		415	
Base Capacity (vph)	574	2130	1121	1023	871	943
Starvation Cap Reductn	0	0	0	96	0	0
Spillback Cap Reductn	0	241	0	0	0	0
Storage Cap Reductn	0	0	0	0	0	0
Reduced v/c Ratio	0.79	0.48	0.69	0.70	0.85	0.36

Intersection Summary

Area Type: Other
 Cycle Length: 120
 Actuated Cycle Length: 120
 Offset: 85 (71%), Referenced to phase 2:EBTL and 6:WBT, Start of 1st Green
 Natural Cycle: 75
 Control Type: Actuated-Coordinated
 Maximum v/c Ratio: 0.87
 Intersection Signal Delay: 27.1
 Intersection Capacity Utilization 80.4%
 Analysis Period (min) 15
 Intersection LOS: C
 ICU Level of Service D
 # 95th percentile volume exceeds capacity, queue may be longer.
 Queue shown is maximum after two cycles.
 m Volume for 95th percentile queue is metered by upstream signal.

Splits and Phases: 2: Welsh Road & Dresher Road



BT Dreshertown, LP
3: Dreshertown Road & Welsh Road

2023 Without AM Peak



Lane Group	EBT	EBR	WBL	WBT	NBL	NBR
Lane Configurations	↑↑	↑	↓	↑↑	↓	↑
Volume (vph)	984	569	434	1041	298	397
Ideal Flow (vphpl)	1800	1800	1800	1800	1800	1800
Lane Width (ft)	11	15	10	12	12	15
Grade (%)	-2%			1%	1%	
Storage Length (ft)		150	175		0	350
Storage Lanes		1	1		2	2
Taper Length (ft)			75		75	
Lane Util. Factor	0.95	1.00	1.00	0.95	0.97	1.00
Frt		0.850				0.850
Flt Protected			0.950		0.950	
Satd. Flow (prot)	3306	1650	1542	3304	3174	1626
Flt Permitted			0.155		0.950	
Satd. Flow (perm)	3306	1650	252	3304	3174	1626
Right Turn on Red		Yes				Yes
Satd. Flow (RTOR)		375				32
Link Speed (mph)	45			45	40	
Link Distance (ft)	550			1040	778	
Travel Time (s)	8.3			15.8	13.3	
Peak Hour Factor	0.98	0.98	0.98	0.98	0.98	0.98
Heavy Vehicles (%)	1%	3%	3%	3%	4%	3%
Adj. Flow (vph)	1004	581	443	1062	304	405
Shared Lane Traffic (%)						
Lane Group Flow (vph)	1004	581	443	1062	304	405
Number of Detectors	1	1	1	1	1	1
Detector Template						
Leading Detector (ft)	5	5	35	5	35	35
Trailing Detector (ft)	0	0	-5	0	-5	-5
Detector 1 Position(ft)	0	0	-5	0	-5	-5
Detector 1 Size(ft)	5	5	40	5	40	40
Detector 1 Type	CI+Ex	CI+Ex	CI+Ex	CI+Ex	CI+Ex	CI+Ex
Detector 1 Channel						
Detector 1 Extend (s)	0.0	0.0	0.0	0.0	0.0	0.0
Detector 1 Queue (s)	0.0	0.0	0.0	0.0	0.0	0.0
Detector 1 Delay (s)	0.0	0.0	0.0	0.0	0.0	0.0
Turn Type	NA	Perm	pm+pt	NA	Prot	pm+ov
Protected Phases	2		1	6	8	1
Permitted Phases		2	6			8
Detector Phase	2	2	1	6	8	1
Switch Phase						
Minimum Initial (s)	20.0	20.0	3.0	20.0	7.0	3.0
Minimum Split (s)	27.0	27.0	10.0	27.0	14.0	10.0
Total Split (s)	52.0	52.0	45.0	97.0	23.0	45.0
Total Split (%)	43.3%	43.3%	37.5%	80.8%	19.2%	37.5%
Maximum Green (s)	45.0	45.0	38.0	90.0	16.0	38.0
Yellow Time (s)	5.0	5.0	5.0	5.0	4.0	5.0
All-Red Time (s)	2.0	2.0	2.0	2.0	3.0	2.0
Lost Time Adjust (s)	-1.0	-1.0	-1.0	-1.0	-1.0	-1.0
Total Lost Time (s)	6.0	6.0	6.0	6.0	6.0	6.0



Lane Group	EBT	EBR	WBL	WBT	NBL	NBR
Lead/Lag	Lag	Lag	Lead			Lead
Lead-Lag Optimize?						
Vehicle Extension (s)	3.0	3.0	3.0	3.0	3.0	3.0
Recall Mode	C-Max	C-Max	None	C-Max	None	None

Intersection Summary

Area Type: Other
 Cycle Length: 120
 Actuated Cycle Length: 120
 Offset: 85 (71%), Referenced to phase 2:EBT and 6:WBTL, Start of 1st Green.
 Natural Cycle: 65
 Control Type: Actuated-Coordinated

Splits and Phases: 3: Dreshertown Road & Welsh Road

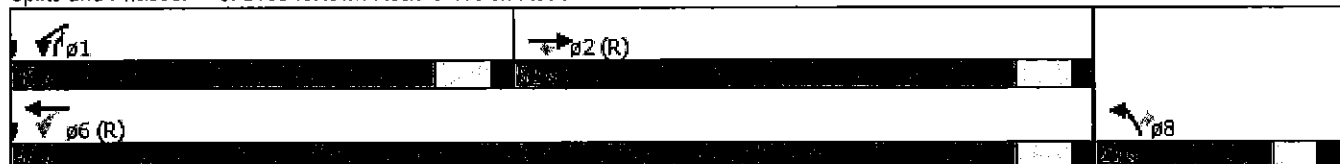



Movement	EBT	EBR	WBL	WBT	NBT	NBR
Lane Configurations	↑↑	↑	↑	↑↑	↑↑	↑
Volume (veh/h)	984	569	434	1041	298	397
Number	2	12	1	6	3	18
Initial Q (Qb), veh	0	0	0	0	0	0
Ped-Bike Adj(A_pbT)		1.00	1.00		1.00	1.00
Parking Bus, Adj	1.00	1.00	1.00	1.00	1.00	1.00
Adj Sat Flow, veh/h/ln	1800	1836	1739	1739	1722	1808
Adj Flow Rate, veh/h	1004	537	443	1062	304	322
Adj No. of Lanes	2	1	1	2	2	1
Peak Hour Factor	0.98	0.98	0.98	0.98	0.98	0.98
Percent Heavy Veh, %	1	3	3	3	4	3
Cap, veh/h	1854	846	514	2505	451	473
Arrive On Green	1.00	1.00	0.33	1.00	0.14	0.14
Sat Flow, veh/h	3510	1560	1656	3391	3182	1537
Grp Volume(v), veh/h	1004	537	443	1062	304	322
Grp Sat Flow(s), veh/h/ln	1710	1560	1656	1652	1591	1537
Q Serve(g_s), s	0.0	0.0	15.0	0.0	10.9	17.0
Cycle Q Clear(g_c), s	0.0	0.0	15.0	0.0	10.9	17.0
Prop In Lane		1.00	1.00		1.00	1.00
Lane Grp Cap(c), veh/h	1854	846	514	2505	451	473
V/C Ratio(X)	0.54	0.63	0.86	0.42	0.67	0.68
Avail Cap(c_a), veh/h	1854	846	777	2505	451	473
HCM Platoon Ratio	2.00	2.00	2.00	2.00	1.00	1.00
Upstream Filter(I)	0.74	0.74	0.85	0.85	1.00	1.00
Uniform Delay (d), s/veh	0.0	0.0	7.2	0.0	48.9	36.3
Incr Delay (d2), s/veh	0.8	2.7	5.5	0.5	3.9	3.9
Initial Q Delay(d3),s/veh	0.0	0.0	0.0	0.0	0.0	0.0
%ile BackOfQ(95%),veh/ln	0.4	1.1	11.5	0.3	8.7	15.0
LnGrp Delay(d),s/veh	0.8	2.7	12.8	0.5	52.8	40.3
LnGrp LOS	A	A	B	A	D	D
Approach Vol, veh/h	1541			1505	626	
Approach Delay, s/veh	1.5			4.1	46.4	
Approach LOS	A			A	D	

Timer	1	2	3	4	5	6	7	8
Assigned Phs	1	2				6		8
Phs Duration (G+Y+Rc), s	26.0	71.0				97.0		23.0
Change Period (Y+Rc), s	7.0	7.0				7.0		7.0
Max Green Setting (Gmax), s	38.0	45.0				90.0		16.0
Max Q Clear Time (g_c+I1), s	17.5	2.5				2.5		19.5
Green Ext Time (p_c), s	1.5	12.4				13.1		0.0

Intersection Summary	
HCM 2010 Ctrl Delay	10.2
HCM 2010 LOS	B

BT Dreshertown, LP
4: Dryden Road & Welsh Road

2023 Without AM Peak



Lane Group	EBL	EBT	EBR	WBL	WBT	WBR	NBL	NBT	NBR	SBL	SBT	SBR
Lane Configurations												
Volume (vph)	1	1290	96	57	1539	1	2	0	0	2	0	0
Ideal Flow (vphpl)	1800	1800	1800	1800	1800	1800	1800	1800	1800	1800	1800	1800
Lane Width (ft)	10	12	14	10	12	12	11	15	15	12	14	14
Grade (%)		-1%			-1%			-1%			0%	
Storage Length (ft)	150		225	175		0	110		0	150		0
Storage Lanes	1		1	1		0	1		0	1		0
Taper Length (ft)	75			75			75			75		
Lane Util. Factor	1.00	0.95	1.00	1.00	0.95	0.95	1.00	1.00	1.00	1.00	1.00	1.00
Frnt			0.850									
Flt Protected	0.950			0.950			0.950			0.950		
Satd. Flow (prot)	1604	3403	1640	1573	3370	0	1661	1990	0	1710	1920	0
Flt Permitted	0.139			0.188								
Satd. Flow (perm)	235	3403	1640	311	3370	0	1749	1990	0	1800	1920	0
Right Turn on Red			Yes			Yes			Yes			Yes
Satd. Flow (RTOR)			103									
Link Speed (mph)		45			45			25			25	
Link Distance (ft)		1040			1416			754			960	
Travel Time (s)		15.8			21.5			20.6			26.2	
Peak Hour Factor	0.93	0.93	0.93	0.93	0.93	0.93	0.93	0.93	0.93	0.93	0.93	0.93
Heavy Vehicles (%)	0%	1%	0%	2%	2%	0%	0%	0%	0%	0%	0%	0%
Adj. Flow (vph)	1	1387	103	61	1655	1	2	0	0	2	0	0
Shared Lane Traffic (%)												
Lane Group Flow (vph)	1	1387	103	61	1656	0	2	0	0	2	0	0
Number of Detectors	1	1	1	1	1		1	1		1	1	
Detector Template												
Leading Detector (ft)	5	5	5	5	5		35	35		35	35	
Trailing Detector (ft)	0	0	0	0	0		-5	-5		-5	-5	
Detector 1 Position(ft)	0	0	0	0	0		-5	-5		-5	-5	
Detector 1 Size(ft)	5	5	5	5	5		40	40		40	40	
Detector 1 Type	CI+Ex	CI+Ex	CI+Ex	CI+Ex	CI+Ex		CI+Ex	CI+Ex		CI+Ex	CI+Ex	
Detector 1 Channel												
Detector 1 Extend (s)	0.0	0.0	0.0	0.0	0.0		0.0	0.0		0.0	0.0	
Detector 1 Queue (s)	0.0	0.0	0.0	0.0	0.0		0.0	0.0		0.0	0.0	
Detector 1 Delay (s)	0.0	0.0	0.0	0.0	0.0		0.0	0.0		0.0	0.0	
Turn Type	Perm	NA	Perm	Perm	NA		Perm			Perm		
Protected Phases		2			6			8				4
Permitted Phases	2		2	6			8			4		
Detector Phase	2	2	2	6	6		8	8		4	4	
Switch Phase												
Minimum Initial (s)	21.0	21.0	21.0	21.0	21.0		5.0	5.0		5.0	5.0	
Minimum Split (s)	27.0	27.0	27.0	27.0	27.0		11.0	11.0		11.0	11.0	
Total Split (s)	107.0	107.0	107.0	107.0	107.0		13.0	13.0		13.0	13.0	
Total Split (%)	89.2%	89.2%	89.2%	89.2%	89.2%		10.8%	10.8%		10.8%	10.8%	
Maximum Green (s)	101.0	101.0	101.0	101.0	101.0		7.0	7.0		7.0	7.0	
Yellow Time (s)	4.0	4.0	4.0	4.0	4.0		3.0	3.0		3.0	3.0	
All-Red Time (s)	2.0	2.0	2.0	2.0	2.0		3.0	3.0		3.0	3.0	
Lost Time Adjust (s)	-1.0	-1.0	-1.0	-1.0	-1.0		-1.0	-1.0		-1.0	-1.0	
Total Lost Time (s)	5.0	5.0	5.0	5.0	5.0		5.0	5.0		5.0	5.0	

BT Dreshertown, LP
 4: Dryden Road & Welsh Road

2023 Without AM Peak



Lane Group	EBL	EBT	EBR	WBL	WBT	WBR	NBL	NBT	NBR	SBL	SBT	SBR
Lead/Lag												
Lead-Lag Optimize?												
Vehicle Extension (s)	3.0	3.0	3.0	3.0	3.0		3.0	3.0		3.0	3.0	
Recall Mode	C-Max	C-Max	C-Max	C-Max	C-Max		None	None		None	None	

Intersection Summary
 Area Type: Other
 Cycle Length: 120
 Actuated Cycle Length: 120
 Offset: 62 (52%), Referenced to phase 2:EBTL and 6:WBTL, Start of 1st Green
 Natural Cycle: 45
 Control Type: Actuated-Coordinated

Splits and Phases: 4: Dryden Road & Welsh Road

Ø2 (R)	Ø4
Ø6 (R)	Ø8



Movement	EBL	EBT	EBR	WBL	WBT	WBR	NBL	NBT	NBR	SEL	SET	SEB
Lane Configurations	↖	↗	↘	↖	↗	↘	↖	↗	↘	↖	↗	↘
Volume (veh/h)	1	1290	96	57	1539	1	2	0	0	2	0	0
Number	5	2	12	1	6	16	3	8	18	7	4	14
Initial Q (Qb), veh	0	0	0	0	0	0	0	0	0	0	0	0
Ped-Bike Adj(A_pbT)	1.00		1.00	1.00		1.00	1.00		1.00	1.00		1.00
Parking Bus, Adj	1.00	1.00	1.00	1.00	1.00	1.00	1.00	1.00	1.00	1.00	1.00	1.00
Adj Sat Flow, veh/h/ln	1809	1791	1881	1774	1774	1809	1809	1881	1881	1800	1872	1872
Adj Flow Rate, veh/h	1	1387	101	61	1655	1	2	0	0	2	0	0
Adj No. of Lanes	1	2	1	1	2	0	1	1	0	1	1	0
Peak Hour Factor	0.93	0.93	0.93	0.93	0.93	0.93	0.93	0.93	0.93	0.93	0.93	0.93
Percent Heavy Veh, %	0	1	0	2	2	2	0	0	0	0	0	0
Cap, veh/h	310	3073	1444	380	3121	2	80	25	0	79	25	0
Arrive On Green	1.00	1.00	1.00	0.90	0.90	0.89	0.01	0.00	0.00	0.01	0.00	0.00
Sat Flow, veh/h	307	3403	1599	354	3456	2	1447	1881	0	1440	1872	0
Grp Volume(v), veh/h	1	1387	101	61	807	849	2	0	0	2	0	0
Grp Sat Flow(s),veh/h/ln	307	1702	1599	354	1685	1773	1447	1881	0	1440	1872	0
Q Serve(g_s), s	0.0	0.0	0.0	2.4	10.7	10.7	0.2	0.0	0.0	0.2	0.0	0.0
Cycle Q Clear(g_c), s	10.7	0.0	0.0	2.4	10.7	10.7	0.2	0.0	0.0	0.2	0.0	0.0
Prop In Lane	1.00		1.00	1.00		0.00	1.00		0.00	1.00		0.00
Lane Grp Cap(c), veh/h	310	3073	1444	380	1522	1601	80	25	0	79	25	0
V/C Ratio(X)	0.00	0.45	0.07	0.16	0.53	0.53	0.03	0.00	0.00	0.03	0.00	0.00
Avail Cap(c_a), veh/h	310	3073	1444	380	1522	1601	156	125	0	156	125	0
HCM Platoon Ratio	2.00	2.00	2.00	1.00	1.00	1.00	1.00	1.00	1.00	1.00	1.00	1.00
Upstream Filter(I)	0.73	0.73	0.73	1.00	1.00	1.00	1.00	0.00	0.00	1.00	0.00	0.00
Uniform Delay (d), s/veh	0.5	0.0	0.0	0.7	1.1	1.1	58.5	0.0	0.0	58.5	0.0	0.0
Incr Delay (d2), s/veh	0.0	0.4	0.1	0.9	1.3	1.3	0.1	0.0	0.0	0.1	0.0	0.0
Initial Q Delay(d3),s/veh	0.0	0.0	0.0	0.0	0.0	0.0	0.0	0.0	0.0	0.0	0.0	0.0
%ile BackOfQ(95%),veh/ln	0.0	0.3	0.0	0.6	9.0	9.4	0.1	0.0	0.0	0.1	0.0	0.0
LnGrp Delay(d),s/veh	0.5	0.4	0.1	1.6	2.4	2.3	58.6	0.0	0.0	58.6	0.0	0.0
LnGrp LOS	A	A	A	A	A	A	E			E		
Approach Vol, veh/h		1489			1717			2			2	
Approach Delay, s/veh		0.3			2.3			58.6			58.6	
Approach LOS		A			A			E			E	

Timer	1	2	3	4	5	6	7	8
Assigned Phs		2		4		6		8
Phs Duration (G+Y+Rc), s		113.4		6.6		113.4		6.6
Change Period (Y+Rc), s		6.0		6.0		6.0		6.0
Max Green Setting (Gmax), s		101.0		7.0		101.0		7.0
Max Q Clear Time (g_c+I1), s		13.2		2.7		13.2		2.7
Green Ext Time (p_c), s		21.8		0.0		21.8		0.0

Intersection Summary	
HCM 2010 Ctrl Delay	1.5
HCM 2010 LOS	A

1: Jarretstown Road/Village Road & Welsh Road

Lane Group	EBL	EBT	EBR	WBL	WBT	WBR	NBL	NET	NBR	SBL	SBT	SBR
Lane Configurations												
Volume (vph)	22	818	30	269	1008	15	22	21	269	42	94	108
Ideal Flow (vphpl)	1800	1800	1800	1800	1800	1800	1800	1800	1800	1800	1800	1800
Lane Width (ft)	12	12	12	11	14	14	12	12	14	15	15	15
Grade (%)		-6%			1%			-1%			1%	
Storage Length (ft)	150		0	100		0	0		175	0		0
Storage Lanes	1		0	1		0	0		1	0		0
Taper Length (ft)	75			75			75			75		
Lane Util. Factor	1.00	1.00	1.00	1.00	1.00	1.00	1.00	1.00	1.00	1.00	1.00	1.00
Frt		0.995			0.998				0.850		0.940	
Flt Protected	0.950			0.950				0.975			0.991	
Satd. Flow (prot)	1761	1827	0	1645	1907	0	0	1764	1640	0	1826	0
Flt Permitted	0.207			0.065				0.642			0.935	
Satd. Flow (perm)	384	1827	0	113	1907	0	0	1161	1640	0	1723	0
Right Turn on Red			Yes			Yes			Yes			Yes
Satd. Flow (RTOR)		2			1				92		31	
Link Speed (mph)		45			45			35			35	
Link Distance (ft)		1263			605			421			431	
Travel Time (s)		19.1			9.2			8.2			8.4	
Peak Hour Factor	0.96	0.96	0.96	0.96	0.96	0.96	0.96	0.96	0.96	0.96	0.96	0.96
Heavy Vehicles (%)	0%	1%	0%	0%	0%	0%	0%	0%	0%	3%	0%	0%
Adj. Flow (vph)	23	852	31	280	1050	16	23	22	280	44	98	112
Shared Lane Traffic (%)												
Lane Group Flow (vph)	23	883	0	280	1066	0	0	45	280	0	254	0
Number of Detectors	1	2		1	2		1	1	1	1	1	
Detector Template	Left			Left			Left	Thru	Right	Left	Thru	
Leading Detector (ft)	5	330		35	330		20	35	35	20	35	
Trailing Detector (ft)	0	0		-5	0		0	-5	-5	0	-5	
Detector 1 Position(ft)	0	0		-5	0		0	-5	-5	0	-5	
Detector 1 Size(ft)	5	6		40	6		20	40	40	20	40	
Detector 1 Type	CI+Ex	CI+Ex		CI+Ex	CI+Ex		CI+Ex	CI+Ex	CI+Ex	CI+Ex	CI+Ex	
Detector 1 Channel												
Detector 1 Extend (s)	0.0	0.0		0.0	0.0		0.0	0.0	0.0	0.0	0.0	
Detector 1 Queue (s)	0.0	0.0		0.0	0.0		0.0	0.0	0.0	0.0	0.0	
Detector 1 Delay (s)	0.0	0.0		0.0	0.0		0.0	0.0	0.0	0.0	0.0	
Detector 2 Position(ft)		324			324							
Detector 2 Size(ft)		6			6							
Detector 2 Type		CI+Ex			CI+Ex							
Detector 2 Channel												
Detector 2 Extend (s)		0.0			0.0							
Turn Type	Perm	NA		pm+pt	NA		Perm	NA	pm+ov	Perm	NA	
Protected Phases		2		1	6			8	1		4	
Permitted Phases				6			8		8	4		
Detector Phase	2	2		1	6		8	8	1	4	4	
Switch Phase												
Minimum Initial (s)	15.0	15.0		3.0	15.0		7.0	7.0	3.0	7.0	7.0	
Minimum Split (s)	22.0	22.0		10.0	22.0		13.0	13.0	10.0	13.0	13.0	
Total Split (s)	61.0	61.0		26.0	87.0		33.0	33.0	26.0	33.0	33.0	
Total Split (%)	50.8%	50.8%		21.7%	72.5%		27.5%	27.5%	21.7%	27.5%	27.5%	

BT Dreshertown, LP
 1: Jarrettown Road/Village Road & Welsh Road

2023 Without PM Peak



Phase Group	EBL	EBT	EBR	WBL	WBT	WBR	NBL	NBT	NBR	SBL	SBT	SBR
Maximum Green (s)	54.0	54.0		19.0	80.0		27.0	27.0	19.0	27.0	27.0	
Yellow Time (s)	5.0	5.0		5.0	5.0		4.0	4.0	5.0	4.0	4.0	
All-Red Time (s)	2.0	2.0		2.0	2.0		2.0	2.0	2.0	2.0	2.0	
Lost Time Adjust (s)	-1.0	-1.0		-1.0	-1.0			-1.0	-1.0		-1.0	
Total Lost Time (s)	6.0	6.0		6.0	6.0		5.0	5.0	6.0		5.0	
Lead/Lag	Lag	Lag		Lead					Lead			
Lead-Lag Optimize?												
Vehicle Extension (s)	3.0	3.0		3.0	3.0		3.0	3.0	3.0	3.0	3.0	
Recall Mode	C-Max	C-Max		None	C-Max		None	None	None	None	None	

Intersection Summary

Area Type: Other
 Cycle Length: 120
 Actuated Cycle Length: 120
 Offset: 5 (4%), Referenced to phase 2:EBTL and 6:WBTL, Start of 1st Green
 Natural Cycle: 90
 Control Type: Actuated-Coordinated

Splits and Phases: 1: Jarrettown Road/Village Road & Welsh Road

BT Dreshertown, LP
1: Jarrettown Road/Village Road & Welsh Road

2023 Without PM Peak



Movement	EBL	EBT	EBR	WBL	WBT	WBR	NBL	NBT	NBR	SBL	SBT	SBR
Lane Configurations	↖	↗		↖	↗		↖	↗		↕	↕	
Volume (veh/h)	22	818	30	269	1008	15	22	21	269	42	94	108
Number	5	2	12	1	6	16	3	8	18	7	4	14
Initial Q (Qb), veh	0	0	0	0	0	0	0	0	0	0	0	0
Ped-Bike Adj(A_pbT)	1.00		1.00	1.00		1.00	1.00		1.00	1.00		1.00
Parking Bus, Adj	1.00	1.00	1.00	1.00	1.00	1.00	1.00	1.00	1.00	1.00	1.00	1.00
Adj Sat Flow, veh/h/ln	1854	1836	1854	1791	1863	1863	1809	1809	1881	1863	1853	1863
Adj Flow Rate, veh/h	23	852	30	280	1050	15	23	22	259	44	98	98
Adj No. of Lanes	1	1	0	1	1	0	0	1	1	0	1	0
Peak Hour Factor	0.96	0.96	0.96	0.96	0.96	0.96	0.96	0.96	0.96	0.96	0.96	0.96
Percent Heavy Veh, %	0	1	1	0	0	0	0	0	0	0	0	0
Cap, veh/h	262	1029	36	346	1332	19	126	108	439	75	132	119
Arrive On Green	0.58	0.58	0.58	0.09	0.73	0.72	0.17	0.18	0.18	0.17	0.18	0.17
Sat Flow, veh/h	554	1763	62	1706	1832	26	447	594	1599	218	730	655
Grp Volume(v), veh/h	23	0	882	280	0	1065	45	0	259	240	0	0
Grp Sat Flow(s),veh/h/ln	554	0	1825	1706	0	1858	1041	0	1599	1603	0	0
Q Serve(g_s), s	3.3	0.0	46.7	7.1	0.0	44.0	0.0	0.0	16.8	12.4	0.0	0.0
Cycle Q Clear(g_c), s	29.5	0.0	46.7	7.1	0.0	44.0	3.2	0.0	16.8	17.4	0.0	0.0
Prop In Lane	1.00		0.03	1.00		0.01	0.51		1.00	0.18		0.41
Lane Grp Cap(c), veh/h	262	0	1065	346	0	1351	225	0	439	313	0	0
V/C Ratio(X)	0.09	0.00	0.83	0.81	0.00	0.79	0.20	0.00	0.59	0.77	0.00	0.00
Avail Cap(c_a), veh/h	262	0	1065	471	0	1351	301	0	523	394	0	0
HCM Platoon Ratio	1.00	1.00	1.00	1.00	1.00	1.00	1.00	1.00	1.00	1.00	1.00	1.00
Upstream Filter(I)	1.00	0.00	1.00	1.00	0.00	1.00	1.00	0.00	1.00	1.00	0.00	0.00
Uniform Delay (d), s/veh	25.2	0.0	20.1	23.1	0.0	10.5	41.6	0.0	37.7	47.5	0.0	0.0
Incr Delay (d2), s/veh	0.7	0.0	7.4	7.4	0.0	4.7	0.4	0.0	1.3	6.9	0.0	0.0
Initial Q Delay(d3),s/veh	0.0	0.0	0.0	0.0	0.0	0.0	0.0	0.0	0.0	0.0	0.0	0.0
%ile BackOfQ(95%),veh/ln	1.0	0.0	33.8	10.4	0.0	32.0	2.4	0.0	12.1	13.1	0.0	0.0
LnGrp Delay(d),s/veh	25.9	0.0	27.6	30.5	0.0	15.2	42.0	0.0	38.9	54.4	0.0	0.0
LnGrp LOS	C		C	C		B	D		D	D		
Approach Vol, veh/h		905			1345			304			240	
Approach Delay, s/veh		27.5			18.4			39.4			54.4	
Approach LOS		C			B			D			D	

Turner	1	2	3	4	5	6	7	8
Assigned Phs	1	2		4		6		8
Phs Duration (G+Y+Rc), s	17.2	76.0		26.7		93.3		26.7
Change Period (Y+Rc), s	7.0	7.0		6.0		7.0		6.0
Max Green Setting (Gmax), s	19.0	54.0		27.0		80.0		27.0
Max Q Clear Time (g_c+I1), s	9.6	48.7		19.4		46.0		19.3
Green Ext Time (p_c), s	0.6	5.2		1.4		32.8		1.4

Intersection Summary	
HCM 2010 Ctrl Delay	26.7
HCM 2010 LOS	C



Lane Group	EBL	EBT	WBT	WBR	SEL	SBR
Lane Configurations	↖	↗	↖	↗	↘	↘
Volume (vph)	315	871	931	597	888	426
Ideal Flow (vphpl)	1800	1800	1800	1800	1800	1800
Lane Width (ft)	10	11	11	11	12	13
Grade (%)		-1%	1%		1%	
Storage Length (ft)	225			210	0	415
Storage Lanes	1			1	2	1
Taper Length (ft)	75				75	
Lane Util. Factor	1.00	0.95	0.95	1.00	0.97	1.00
Frt				0.850		0.850
Flt Protected	0.950				0.950	
Satd. Flow (prot)	1588	3257	3257	1457	3268	1558
Flt Permitted	0.103				0.950	
Satd. Flow (perm)	172	3257	3257	1457	3268	1558
Right Turn on Red				Yes		Yes
Satd. Flow (RTOR)				191		22
Link Speed (mph)		45	45		35	
Link Distance (ft)		475	550		970	
Travel Time (s)		7.2	8.3		18.9	
Peak Hour Factor	0.95	0.95	0.95	0.95	0.95	0.95
Heavy Vehicles (%)	1%	2%	1%	1%	1%	1%
Adj. Flow (vph)	332	917	980	628	935	448
Shared Lane Traffic (%)						
Lane Group Flow (vph)	332	917	980	628	935	448
Number of Detectors	1	1	1	1	1	1
Detector Template						
Leading Detector (ft)	35	5	5	5	35	35
Trailing Detector (ft)	-5	0	0	0	-5	-5
Detector 1 Position(ft)	-5	0	0	0	-5	-5
Detector 1 Size(ft)	40	5	5	5	40	40
Detector 1 Type	CI+Ex	CI+Ex	CI+Ex	CI+Ex	CI+Ex	CI+Ex
Detector 1 Channel						
Detector 1 Extend (s)	0.0	0.0	0.0	0.0	0.0	0.0
Detector 1 Queue (s)	0.0	0.0	0.0	0.0	0.0	0.0
Detector 1 Delay (s)	0.0	0.0	0.0	0.0	0.0	0.0
Turn Type	pm+pt	NA	NA	pm+ov	Prot	pm+ov
Protected Phases	5	2	6	4	4	5
Permitted Phases	2			6		4
Detector Phase	5	2	6	4	4	5
Switch Phase						
Minimum Initial (s)	3.0	20.0	20.0	7.0	7.0	3.0
Minimum Split (s)	9.0	26.0	26.0	14.0	14.0	9.0
Total Split (s)	30.0	76.0	46.0	44.0	44.0	30.0
Total Split (%)	25.0%	63.3%	38.3%	36.7%	36.7%	25.0%
Maximum Green (s)	24.0	70.0	40.0	37.0	37.0	24.0
Yellow Time (s)	4.0	4.0	4.0	4.0	4.0	4.0
All-Red Time (s)	2.0	2.0	2.0	3.0	3.0	2.0
Lost Time Adjust (s)	-1.0	-1.0	-1.0	-1.0	-1.0	-1.0
Total Lost Time (s)	5.0	5.0	5.0	6.0	6.0	5.0

BT Dreshertown, LP
2: Welsh Road & Dresher Road

2023 Without PM Peak



Lane Group	FBL	EBT	WBT	WBR	SEL	SEB
Lead/Lag	Lead		Lag			Lead
Lead-Lag Optimize?						
Vehicle Extension (s)	3.0	3.0	3.0	3.0	3.0	3.0
Recall Mode	None	C-Max	C-Max	None	None	None
Act Effct Green (s)	71.4	71.4	42.9	85.5	37.6	67.1
Actuated g/C Ratio	0.60	0.60	0.36	0.71	0.31	0.56
v/c Ratio	0.88	0.47	0.84	0.57	0.91	0.51
Control Delay	38.5	17.7	40.1	7.2	53.7	17.4
Queue Delay	0.0	0.1	0.2	0.4	0.0	0.1
Total Delay	38.5	17.9	40.3	7.5	53.7	17.5
LOS	D	B	D	A	D	B
Approach Delay		23.4	27.5		42.0	
Approach LOS		C	C		D	
Queue Length 50th (ft)	186	291	314	145	356	186
Queue Length 95th (ft)	m228	m314	#440	218	#475	272
Internal Link Dist (ft)		395	470		890	
Turn Bay Length (ft)	225			210		415
Base Capacity (vph)	397	1937	1163	1097	1034	900
Starvation Cap Reductn	0	0	12	126	0	0
Spillback Cap Reductn	0	246	0	0	0	39
Storage Cap Reductn	0	0	0	0	0	0
Reduced v/c Ratio	0.84	0.54	0.85	0.65	0.90	0.52

Intersection Summary

Area Type: Other
 Cycle Length: 120
 Actuated Cycle Length: 120
 Offset: 77 (64%), Referenced to phase 2:EBTL and 6:WBT, Start of 1st Green
 Natural Cycle: 80
 Control Type: Actuated-Coordinated
 Maximum v/c Ratio: 0.91
 Intersection Signal Delay: 31.0
 Intersection Capacity Utilization 85.7%
 Analysis Period (min) 15
 # 95th percentile volume exceeds capacity, queue may be longer.
 Queue shown is maximum after two cycles.
 m Volume for 95th percentile queue is metered by upstream signal.

Splits and Phases: 2: Welsh Road & Dresher Road

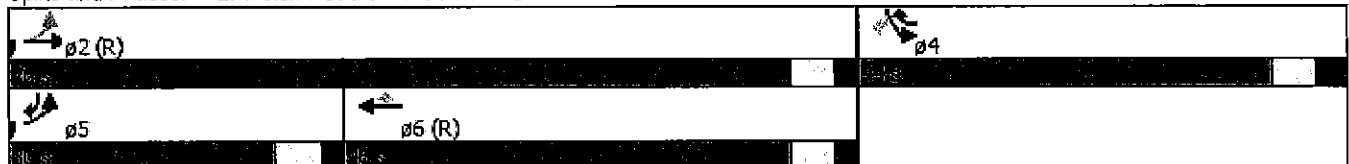



Lane Group	EBT	EBR	WBL	WBT	NBL	NBR
Lane Configurations	↑↑	↑	↘	↑↑	↘	↑
Volume (vph)	1162	597	482	1103	424	470
Ideal Flow (vphpl)	1800	1800	1800	1800	1800	1800
Lane Width (ft)	11	15	10	12	12	15
Grade (%)	-2%			1%	1%	
Storage Length (ft)		150	175		0	350
Storage Lanes		1	1		2	2
Taper Length (ft)			75		75	
Lane Util. Factor	0.95	1.00	1.00	0.95	0.97	1.00
Frt		0.850				0.850
Flt Protected			0.950		0.950	
Satd. Flow (prot)	3274	1683	1557	3369	3268	1626
Flt Permitted			0.076		0.950	
Satd. Flow (perm)	3274	1683	125	3369	3268	1626
Right Turn on Red		Yes				Yes
Satd. Flow (RTOR)		333				15
Link Speed (mph)	45			45	40	
Link Distance (ft)	550			1040	778	
Travel Time (s)	8.3			15.8	13.3	
Peak Hour Factor	0.96	0.96	0.96	0.96	0.96	0.96
Heavy Vehicles (%)	2%	1%	2%	1%	1%	3%
Adj. Flow (vph)	1210	622	502	1149	442	490
Shared Lane Traffic (%)						
Lane Group Flow (vph)	1210	622	502	1149	442	490
Number of Detectors	1	1	1	1	1	1
Detector Template						
Leading Detector (ft)	5	5	35	5	35	35
Trailing Detector (ft)	0	0	-5	0	-5	-5
Detector 1 Position(ft)	0	0	-5	0	-5	-5
Detector 1 Size(ft)	5	5	40	5	40	40
Detector 1 Type	CI+Ex	CI+Ex	CI+Ex	CI+Ex	CI+Ex	CI+Ex
Detector 1 Channel						
Detector 1 Extend (s)	0.0	0.0	0.0	0.0	0.0	0.0
Detector 1 Queue (s)	0.0	0.0	0.0	0.0	0.0	0.0
Detector 1 Delay (s)	0.0	0.0	0.0	0.0	0.0	0.0
Turn Type	NA	Perm	pm+pt	NA	Prot	pm+ov
Protected Phases	2		1	6	8	1
Permitted Phases		2	6			8
Detector Phase	2	2	1	6	8	1
Switch Phase						
Minimum Initial (s)	20.0	20.0	3.0	20.0	7.0	3.0
Minimum Split (s)	27.0	27.0	10.0	27.0	14.0	10.0
Total Split (s)	52.0	52.0	42.0	94.0	26.0	42.0
Total Split (%)	43.3%	43.3%	35.0%	78.3%	21.7%	35.0%
Maximum Green (s)	45.0	45.0	35.0	87.0	19.0	35.0
Yellow Time (s)	5.0	5.0	5.0	5.0	4.0	5.0
All-Red Time (s)	2.0	2.0	2.0	2.0	3.0	2.0
Lost Time Adjust (s)	-1.0	-1.0	-1.0	-1.0	-1.0	-1.0
Total Lost Time (s)	6.0	6.0	6.0	6.0	6.0	6.0



Lane Group	EBT	EBR	WBL	WBT	NBL	NBR
Lead/Lag	Lag	Lag	Lead			Lead
Lead-Lag Optimize?						
Vehicle Extension (s)	3.0	3.0	3.0	3.0	3.0	3.0
Recall Mode	C-Max	C-Max	None	C-Max	None	None

Intersection Summary

Area Type: Other
 Cycle Length: 120
 Actuated Cycle Length: 120
 Offset: 29 (24%), Referenced to phase 2:EBT and 6:WBTL, Start of 1st Green
 Natural Cycle: 90
 Control Type: Actuated-Coordinated

Splits and Phases: 3: Dreshertown Road & Welsh Road

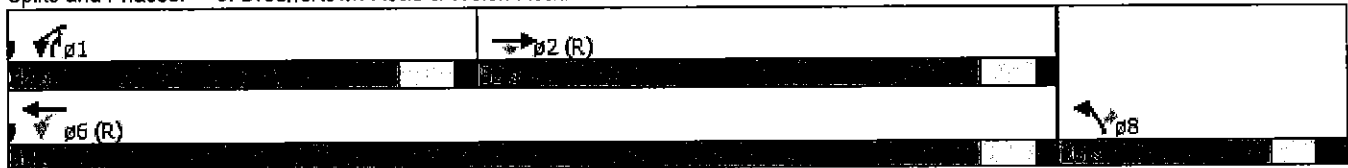



Movement	EBT	EBR	WBL	WBT	NBL	NBR
Lane Configurations	↑↑	↑	↑	↑↑	↑↑	↑
Volume (veh/h)	1162	597	482	1103	424	470
Number	2	12	1	6	3	18
Initial Q (Qb), veh	0	0	0	0	0	0
Ped-Bike Adj(A_pbT)		1.00	1.00		1.00	1.00
Parking Bus, Adj	1.00	1.00	1.00	1.00	1.00	1.00
Adj Sat Flow, veh/h/ln	1782	1872	1756	1773	1773	1808
Adj Flow Rate, veh/h	1210	596	502	1149	442	444
Adj No. of Lanes	2	1	1	2	2	1
Peak Hour Factor	0.96	0.96	0.96	0.96	0.96	0.96
Percent Heavy Veh, %	2	1	2	1	1	3
Cap, veh/h	1410	663	526	2471	546	666
Arrive On Green	0.28	0.28	0.53	1.00	0.17	0.17
Sat Flow, veh/h	3476	1591	1672	3458	3276	1537
Grp Volume(v), veh/h	1210	596	502	1149	442	444
Grp Sat Flow(s), veh/h/ln	1693	1591	1672	1685	1638	1537
Q Serve(g_s), s	40.6	43.3	27.7	0.0	15.6	20.0
Cycle Q Clear(g_c), s	40.6	43.3	27.7	0.0	15.6	20.0
Prop In Lane		1.00	1.00		1.00	1.00
Lane Grp Cap(c), veh/h	1410	663	526	2471	546	666
V/C Ratio(X)	0.86	0.90	0.95	0.47	0.81	0.67
Avail Cap(c_a), veh/h	1410	663	582	2471	546	666
HCM Platoon Ratio	0.67	0.67	2.00	2.00	1.00	1.00
Upstream Filter(I)	0.66	0.66	0.79	0.79	1.00	1.00
Uniform Delay (d), s/veh	39.9	40.8	18.9	0.0	48.2	27.1
Incr Delay (d2), s/veh	4.7	12.5	21.6	0.5	8.9	2.5
Initial Q Delay(d3),s/veh	0.0	0.0	0.0	0.0	0.0	0.0
%ile BackOfQ(95%),veh/ln	25.9	27.5	24.4	0.3	12.3	17.9
LnGrp Delay(d),s/veh	44.6	53.3	40.5	0.5	57.1	29.6
LnGrp LOS	D	D	D	A	E	C
Approach Vol, veh/h	1806			1651	886	
Approach Delay, s/veh	47.5			12.7	43.3	
Approach LOS	D			B	D	

Timer	1	2	3	4	5	6	7	8
Assigned Phs	1	2				6		8
Phs Duration (G+Y+Rc), s	38.0	56.0				94.0		26.0
Change Period (Y+Rc), s	7.0	7.0				7.0		7.0
Max Green Setting (Gmax), s	35.0	45.0				87.0		19.0
Max Q Clear Time (g_c+I1), s	30.2	45.8				2.5		22.5
Green Ext Time (p_c), s	0.9	0.0				17.4		0.0

Intersection Summary	
HCM 2010 Ctrl Delay	33.4
HCM 2010 LOS	C

BT Dreshertown, LP
4: Dryden Road & Welsh Road

2023 Without PM Peak



Lane Group	EBL	EBT	EBR	WBL	WBT	WBR	NBL	NBT	NBR	SBL	SBT	SBR
Lane Configurations	↖	↕	↗	↖	↕	↗	↖	↕	↗	↖	↕	↗
Volume (vph)	0	1665	5	0	1483	0	95	8	9	3	0	1
Ideal Flow (vphpl)	1800	1800	1800	1800	1800	1800	1800	1800	1800	1800	1800	1800
Lane Width (ft)	10	12	14	10	12	12	11	15	15	12	14	14
Grade (%)		-1%			-1%			-1%			0%	
Storage Length (ft)	150		225	175		0	110		0	150		0
Storage Lanes	1		1	1		0	1		0	1		0
Taper Length (ft)	75			75			75			75		
Lane Util. Factor	1.00	0.95	1.00	1.00	0.95	0.95	1.00	1.00	1.00	1.00	1.00	1.00
Frt			0.850					0.921			0.850	
Flt Protected							0.950			0.950		
Satd. Flow (prot)	1688	3403	1640	1688	3370	0	1661	1833	0	1710	1632	0
Flt Permitted							0.757			0.746		
Satd. Flow (perm)	1688	3403	1640	1688	3370	0	1324	1833	0	1343	1632	0
Right Turn on Red			Yes			Yes			Yes			Yes
Satd. Flow (RTOR)			27					9			72	
Link Speed (mph)		45			45			25			25	
Link Distance (ft)		1040			1416			754			960	
Travel Time (s)		15.8			21.5			20.6			26.2	
Peak Hour Factor	0.97	0.97	0.97	0.97	0.97	0.97	0.97	0.97	0.97	0.97	0.97	0.97
Heavy Vehicles (%)	0%	1%	0%	0%	2%	0%	0%	0%	0%	0%	0%	0%
Adj. Flow (vph)	0	1716	5	0	1529	0	98	8	9	3	0	1
Shared Lane Traffic (%)												
Lane Group Flow (vph)	0	1716	5	0	1529	0	98	17	0	3	1	0
Number of Detectors	1	1	1	1	1		1	1		1	1	
Detector Template												
Leading Detector (ft)	5	5	5	5	5		35	35		35	35	
Trailing Detector (ft)	0	0	0	0	0		-5	-5		-5	-5	
Detector 1 Position(ft)	0	0	0	0	0		-5	-5		-5	-5	
Detector 1 Size(ft)	5	5	5	5	5		40	40		40	40	
Detector 1 Type	CI+Ex	CI+Ex	CI+Ex	CI+Ex	CI+Ex		CI+Ex	CI+Ex		CI+Ex	CI+Ex	
Detector 1 Channel												
Detector 1 Extend (s)	0.0	0.0	0.0	0.0	0.0		0.0	0.0		0.0	0.0	
Detector 1 Queue (s)	0.0	0.0	0.0	0.0	0.0		0.0	0.0		0.0	0.0	
Detector 1 Delay (s)	0.0	0.0	0.0	0.0	0.0		0.0	0.0		0.0	0.0	
Turn Type	Perm	NA	Perm	Perm	NA		Perm	NA		Perm	NA	
Protected Phases		2			6			8			4	
Permitted Phases			2	6			8			4		4
Detector Phase	2	2	2	6	6		8	8		4	4	
Switch Phase												
Minimum Initial (s)	21.0	21.0	21.0	21.0	21.0		5.0	5.0		5.0	5.0	
Minimum Split (s)	27.0	27.0	27.0	27.0	27.0		11.0	11.0		11.0	11.0	
Total Split (s)	95.0	95.0	95.0	95.0	95.0		25.0	25.0		25.0	25.0	
Total Split (%)	79.2%	79.2%	79.2%	79.2%	79.2%		20.8%	20.8%		20.8%	20.8%	
Maximum Green (s)	89.0	89.0	89.0	89.0	89.0		19.0	19.0		19.0	19.0	
Yellow Time (s)	4.0	4.0	4.0	4.0	4.0		3.0	3.0		3.0	3.0	
All-Red Time (s)	2.0	2.0	2.0	2.0	2.0		3.0	3.0		3.0	3.0	
Lost Time Adjust (s)	-1.0	-1.0	-1.0	-1.0	-1.0		-1.0	-1.0		-1.0	-1.0	
Total Lost Time (s)	5.0	5.0	5.0	5.0	5.0		5.0	5.0		5.0	5.0	

BT Dreshertown, LP
 4: Dryden Road & Welsh Road

2023 Without PM Peak



Lane Group	FRL	EBT	EBR	WBL	WBT	WBR	NBL	NBT	NBR	SBL	SBT	SBR
Lead/Lag												
Lead-Lag Optimize?												
Vehicle Extension (s)	3.0	3.0	3.0	3.0	3.0		3.0	3.0		3.0	3.0	
Recall Mode	C-Max	C-Max	C-Max	C-Max	C-Max		None	None		None	None	

Intersection Summary

Area Type: Other
 Cycle Length: 120
 Actuated Cycle Length: 120
 Offset: 59 (49%), Referenced to phase 2:EBTL and 6:WBTL, Start of 1st Green
 Natural Cycle: 50
 Control Type: Actuated-Coordinated

Splits and Phases: 4: Dryden Road & Welsh Road

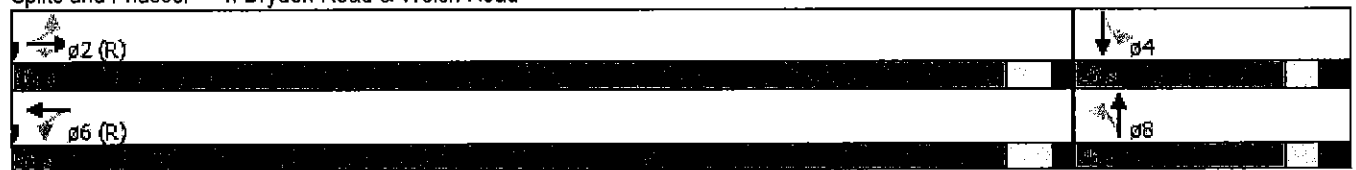

Movement	EBL	EBT	EBR	WBL	WBT	WBR	NBL	NET	NBR	SBL	SBT	SBR
Lane Configurations												
Volume (veh/h)	0	1665	5	0	1483	0	95	8	9	3	0	1
Number	5	2	12	1	6	16	3	8	18	7	4	14
Initial Q (Qb), veh	0	0	0	0	0	0	0	0	0	0	0	0
Ped-Bike Adj(A_pbT)	1.00		1.00	1.00		1.00	1.00		1.00	1.00		1.00
Parking Bus, Adj	1.00	1.00	1.00	1.00	1.00	1.00	1.00	1.00	1.00	1.00	1.00	1.00
Adj Sat Flow, veh/h/ln	1809	1791	1881	1809	1774	1809	1809	1881	1881	1800	1872	1872
Adj Flow Rate, veh/h	0	1716	3	0	1529	0	98	8	9	3	0	1
Adj No. of Lanes	1	2	1	1	2	0	1	1	0	1	1	0
Peak Hour Factor	0.97	0.97	0.97	0.97	0.97	0.97	0.97	0.97	0.97	0.97	0.97	0.97
Percent Heavy Veh, %	0	1	0	0	2	2	0	0	0	0	0	0
Cap, veh/h	60	2797	1314	60	2769	0	197	77	86	188	0	151
Arrive On Green	0.00	1.00	1.00	0.00	0.82	0.00	0.09	0.09	0.09	0.09	0.00	0.09
Sat Flow, veh/h	347	3403	1599	289	3458	0	1446	810	911	1418	0	1591
Grp Volume(v), veh/h	0	1716	3	0	1529	0	98	0	17	3	0	1
Grp Sat Flow(s),veh/h/ln	347	1702	1599	289	1685	0	1446	0	1721	1418	0	1591
Q Serve(g_s), s	0.0	0.0	0.0	0.0	17.8	0.0	7.9	0.0	1.1	0.2	0.0	0.1
Cycle Q Clear(g_c), s	0.0	0.0	0.0	0.0	17.8	0.0	7.9	0.0	1.1	0.8	0.0	0.1
Prop In Lane	1.00		1.00	1.00		0.00	1.00		0.53	1.00		1.00
Lane Grp Cap(c), veh/h	60	2797	1314	60	2769	0	197	0	163	188	0	151
V/C Ratio(X)	0.00	0.61	0.00	0.00	0.55	0.00	0.50	0.00	0.10	0.02	0.00	0.01
Avail Cap(c_a), veh/h	60	2797	1314	60	2769	0	301	0	287	289	0	265
HCM Platoon Ratio	2.00	2.00	2.00	1.00	1.00	1.00	1.00	1.00	1.00	1.00	1.00	1.00
Upstream Filter(I)	0.00	0.42	0.42	0.00	1.00	0.00	1.00	0.00	1.00	1.00	0.00	1.00
Uniform Delay (d), s/veh	0.0	0.0	0.0	0.0	3.5	0.0	52.7	0.0	49.9	49.8	0.0	49.6
Incr Delay (d2), s/veh	0.0	0.4	0.0	0.0	0.8	0.0	1.9	0.0	0.3	0.0	0.0	0.0
Initial Q Delay(d3),s/veh	0.0	0.0	0.0	0.0	0.0	0.0	0.0	0.0	0.0	0.0	0.0	0.0
%ile BackOfQ(95%),veh/ln	0.0	0.3	0.0	0.0	13.1	0.0	5.9	0.0	1.0	0.2	0.0	0.1
LnGrp Delay(d),s/veh	0.0	0.4	0.0	0.0	4.3	0.0	54.7	0.0	50.2	49.8	0.0	49.7
LnGrp LOS		A	A		A		D		D	D		D
Approach Vol, veh/h		1719			1529			115				4
Approach Delay, s/veh		0.4			4.3			54.0				49.8
Approach LOS		A			A			D				D
Timer	1	2	3	4	5	6	7	8				
Assigned Phs		2		4		6		8				
Phs Duration (G+Y+Rc), s		103.6		16.4		103.6		16.4				
Change Period (Y+Rc), s		6.0		6.0		6.0		6.0				
Max Green Setting (Gmax), s		89.0		19.0		89.0		19.0				
Max Q Clear Time (g_c+I1), s		2.5		3.3		20.3		10.4				
Green Ext Time (p_c), s		24.2		0.3		23.2		0.2				
Intersection Summary												
HCM 2010 Ctrl Delay			4.1									
HCM 2010 LOS			A									

BT Dreshertown, LP
1: Jarretstown Road/Village Road & Welsh Road

2023 Without SAT Peak



Lane Group	EBL	EBT	EBR	WBL	WBT	WBR	NBL	NBT	NBR	SBL	SBT	SBR
Lane Configurations	↖	↗		↖	↗			↖	↗		↕	
Volume (vph)	11	622	20	138	581	8	7	2	191	13	2	7
Ideal Flow (vphpl)	1800	1800	1800	1800	1800	1800	1800	1800	1800	1800	1800	1800
Lane Width (ft)	12	12	12	11	14	14	12	12	14	15	15	15
Grade (%)		-6%			1%			-1%			1%	
Storage Length (ft)	150		0	100		0	0		175	0		0
Storage Lanes	1		0	1		0	0		1	0		0
Taper Length (ft)	75			75			75			75		
Lane Util. Factor	1.00	1.00	1.00	1.00	1.00	1.00	1.00	1.00	1.00	1.00	1.00	1.00
Frt		0.995			0.998				0.850		0.955	
Flt Protected	0.950			0.950				0.962			0.972	
Satd. Flow (prot)	1761	1813	0	1612	1907	0	0	1740	1640	0	1829	0
Flt Permitted	0.419			0.299				0.857			0.815	
Satd. Flow (perm)	777	1813	0	508	1907	0	0	1550	1640	0	1533	0
Right Turn on Red			Yes			Yes			Yes			Yes
Satd. Flow (RTOR)		3			2				210		8	
Link Speed (mph)		45			45			35			35	
Link Distance (ft)		1263			605			421			431	
Travel Time (s)		19.1			9.2			8.2			8.4	
Peak Hour Factor	0.91	0.91	0.91	0.91	0.91	0.91	0.91	0.91	0.91	0.91	0.91	0.91
Heavy Vehicles (%)	0%	1%	25%	2%	0%	0%	0%	0%	0%	0%	0%	0%
Adj. Flow (vph)	12	684	22	152	638	9	8	2	210	14	2	8
Shared Lane Traffic (%)												
Lane Group Flow (vph)	12	706	0	152	647	0	0	10	210	0	24	0
Number of Detectors	1	2		1	2		1	1	1	1	1	
Detector Template	Left			Left			Left	Thru	Right	Left	Thru	
Leading Detector (ft)	5	330		35	330		20	35	35	20	35	
Trailing Detector (ft)	0	0		-5	0		0	-5	-5	0	-5	
Detector 1 Position (ft)	0	0		-5	0		0	-5	-5	0	-5	
Detector 1 Size (ft)	5	6		40	6		20	40	40	20	40	
Detector 1 Type	CI+Ex	CI+Ex		CI+Ex	CI+Ex		CI+Ex	CI+Ex	CI+Ex	CI+Ex	CI+Ex	
Detector 1 Channel												
Detector 1 Extend (s)	0.0	0.0		0.0	0.0		0.0	0.0	0.0	0.0	0.0	
Detector 1 Queue (s)	0.0	0.0		0.0	0.0		0.0	0.0	0.0	0.0	0.0	
Detector 1 Delay (s)	0.0	0.0		0.0	0.0		0.0	0.0	0.0	0.0	0.0	
Detector 2 Position (ft)		324			324							
Detector 2 Size (ft)		6			6							
Detector 2 Type		CI+Ex			CI+Ex							
Detector 2 Channel												
Detector 2 Extend (s)		0.0			0.0							
Turn Type	Perm	NA		pm+pt	NA		Perm	NA	pm+ov	Perm	NA	
Protected Phases		2		1	6			8	1		4	
Permitted Phases	2			6			8		8	4		
Detector Phase	2	2		1	6		8	8	1	4	4	
Switch Phase												
Minimum Initial (s)	15.0	15.0		3.0	15.0		7.0	7.0	3.0	7.0	7.0	
Minimum Split (s)	22.0	22.0		10.0	22.0		13.0	13.0	10.0	13.0	13.0	
Total Split (s)	63.0	63.0		19.0	82.0		18.0	18.0	19.0	18.0	18.0	
Total Split (%)	63.0%	63.0%		19.0%	82.0%		18.0%	18.0%	19.0%	18.0%	18.0%	

1: Jarrettown Road/Village Road & Welsh Road



Lane Group	EBL	EBT	EBR	WBL	WBT	WBR	NBL	NBT	NBR	SEL	SBT	SEB
Maximum Green (s)	56.0	56.0		12.0	75.0		12.0	12.0	12.0	12.0	12.0	
Yellow Time (s)	5.0	5.0		5.0	5.0		4.0	4.0	5.0	4.0	4.0	
All-Red Time (s)	2.0	2.0		2.0	2.0		2.0	2.0	2.0	2.0	2.0	
Lost Time Adjust (s)	-1.0	-1.0		-1.0	-1.0			-1.0	-1.0		-1.0	
Total Lost Time (s)	6.0	6.0		6.0	6.0			5.0	6.0		5.0	
Lead/Lag	Lag	Lag		Lead					Lead			
Lead-Lag Optimize?												
Vehicle Extension (s)	3.0	3.0		3.0	3.0		3.0	3.0	3.0	3.0	3.0	
Recall Mode	C-Max	C-Max		None	C-Max		None	None	None	None	None	

Intersection Summary

Area Type: Other
 Cycle Length: 100
 Actuated Cycle Length: 100
 Offset: 26 (26%), Referenced to phase 2:EBTL and 6:WBTL, Start of 1st Green
 Natural Cycle: 60
 Control Type: Actuated-Coordinated

Splits and Phases: 1: Jarrettown Road/Village Road & Welsh Road

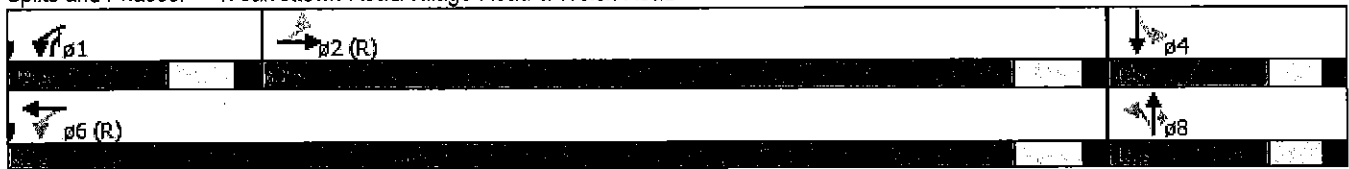



Movement	FBL	EBT	EBR	WBL	WBT	WBR	NBL	NBT	NBR	SEL	SBT	SBR
Lane Configurations	↖	↗		↖	↗		↖	↗	↕		↕	
Volume (veh/h)	11	622	20	138	581	8	7	2	191	13	2	7
Number	5	2	12	1	6	16	3	8	18	7	4	14
Initial Q (Qb), veh	0	0	0	0	0	0	0	0	0	0	0	0
Ped-Bike Adj(A_pbT)	1.00		1.00	1.00		1.00	1.00		1.00	1.00		1.00
Parking Bus, Adj	1.00	1.00	1.00	1.00	1.00	1.00	1.00	1.00	1.00	1.00	1.00	1.00
Adj Sat Flow, veh/h/ln	1854	1822	1854	1756	1863	1863	1809	1809	1881	1863	1863	1863
Adj Flow Rate, veh/h	12	684	21	152	638	9	8	2	112	14	2	3
Adj No. of Lanes	1	1	0	1	1	0	0	1	1	0	1	0
Peak Hour Factor	0.91	0.91	0.91	0.91	0.91	0.91	0.91	0.91	0.91	0.91	0.91	0.91
Percent Heavy Veh, %	0	1	1	2	0	0	0	0	0	0	0	0
Cap, veh/h	623	1181	36	517	1452	20	177	38	253	156	26	22
Arrive On Green	0.67	0.67	0.66	0.06	0.79	0.78	0.09	0.10	0.10	0.09	0.10	0.09
Sat Flow, veh/h	820	1759	54	1672	1832	26	1145	389	1599	961	261	229
Grp Volume(v), veh/h	12	0	705	152	0	647	10	0	112	19	0	0
Grp Sat Flow(s), veh/h/ln	820	0	1813	1672	0	1858	1534	0	1599	1451	0	0
Q Serve(g_s), s	0.5	0.0	20.9	2.4	0.0	11.1	0.0	0.0	6.3	0.3	0.0	0.0
Cycle Q Clear(g_c), s	0.5	0.0	20.9	2.4	0.0	11.1	0.5	0.0	6.3	1.0	0.0	0.0
Prop In Lane	1.00		0.03	1.00		0.01	0.80		1.00	0.74		0.16
Lane Grp Cap(c), veh/h	623	0	1217	517	0	1472	199	0	253	190	0	0
V/C Ratio(X)	0.02	0.00	0.58	0.29	0.00	0.44	0.05	0.00	0.44	0.10	0.00	0.00
Avail Cap(c_a), veh/h	623	0	1217	633	0	1472	248	0	305	236	0	0
HCM Platoon Ratio	1.00	1.00	1.00	1.00	1.00	1.00	1.00	1.00	1.00	1.00	1.00	1.00
Upstream Filter(I)	1.00	0.00	1.00	1.00	0.00	1.00	1.00	0.00	1.00	1.00	0.00	0.00
Uniform Delay (d), s/veh	5.5	0.0	8.8	6.6	0.0	3.3	41.3	0.0	38.1	41.6	0.0	0.0
Incr Delay (d2), s/veh	0.1	0.0	2.0	0.3	0.0	1.0	0.1	0.0	1.2	0.2	0.0	0.0
Initial Q Delay(d3),s/veh	0.0	0.0	0.0	0.0	0.0	0.0	0.0	0.0	0.0	0.0	0.0	0.0
%ile BackOfQ(95%),veh/ln	0.2	0.0	16.5	2.2	0.0	10.0	0.5	0.0	5.2	0.9	0.0	0.0
LnGrp Delay(d),s/veh	5.5	0.0	10.9	6.9	0.0	4.3	41.4	0.0	39.3	41.8	0.0	0.0
LnGrp LOS	A		B	A		A	D		D	D		
Approach Vol, veh/h		717			799			122				19
Approach Delay, s/veh		10.8			4.8			39.5				41.8
Approach LOS		B			A			D				D

Timer	1	2	3	4	5	6	7	8
Assigned Phs	1	2		4		6		8
Phs Duration (G+Y+Rc), s	12.1	73.1		14.8		85.2		14.8
Change Period (Y+Rc), s	7.0	7.0		6.0		7.0		6.0
Max Green Setting (Gmax), s	12.0	56.0		12.0		75.0		12.0
Max Q Clear Time (g_c+I1), s	4.9	22.9		3.0		13.1		8.8
Green Ext Time (p_c), s	0.2	26.3		0.3		42.2		0.1

Intersection Summary	
HCM 2010 Ctrl Delay	10.3
HCM 2010 LOS	B

BT Dreshertown, LP
2: Welsh Road & Dresher Road

2023 Without SAT Peak

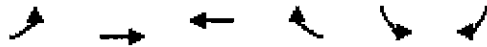

Lane Group	EBL	EBT	WBT	WBR	SBL	SBR
Lane Configurations	↖	↗	↖	↗	↘	↘
Volume (vph)	154	704	618	393	356	148
Ideal Flow (vphpl)	1800	1800	1800	1800	1800	1800
Lane Width (ft)	10	11	11	11	12	13
Grade (%)		-1%	1%		1%	
Storage Length (ft)	225			210	0	415
Storage Lanes	1			1	2	1
Taper Length (ft)	75				75	
Lane Util. Factor	1.00	0.95	0.95	1.00	0.97	1.00
Frt				0.850		0.850
Flt Protected	0.950				0.950	
Satd. Flow (prot)	1573	3290	3257	1472	3301	1542
Flt Permitted	0.325				0.950	
Satd. Flow (perm)	538	3290	3257	1472	3301	1542
Right Turn on Red				Yes		Yes
Satd. Flow (RTOR)				423		121
Link Speed (mph)		45	45		35	
Link Distance (ft)		475	550		970	
Travel Time (s)		7.2	8.3		18.9	
Peak Hour Factor	0.93	0.93	0.93	0.93	0.93	0.93
Heavy Vehicles (%)	2%	1%	1%	0%	0%	2%
Adj. Flow (vph)	166	757	665	423	383	159
Shared Lane Traffic (%)						
Lane Group Flow (vph)	166	757	665	423	383	159
Number of Detectors	1	1	1	1	1	1
Detector Template						
Leading Detector (ft)	35	5	5	5	35	35
Trailing Detector (ft)	-5	0	0	0	-5	-5
Detector 1 Position(ft)	-5	0	0	0	-5	-5
Detector 1 Size(ft)	40	5	5	5	40	40
Detector 1 Type	Cl+Ex	Cl+Ex	Cl+Ex	Cl+Ex	Cl+Ex	Cl+Ex
Detector 1 Channel						
Detector 1 Extend (s)	0.0	0.0	0.0	0.0	0.0	0.0
Detector 1 Queue (s)	0.0	0.0	0.0	0.0	0.0	0.0
Detector 1 Delay (s)	0.0	0.0	0.0	0.0	0.0	0.0
Turn Type	pm+pt	NA	NA	pm+ov	Prot	pm+ov
Protected Phases	5	2	6	4	4	5
Permitted Phases	2			6		4
Detector Phase	5	2	6	4	4	5
Switch Phase						
Minimum Initial (s)	3.0	20.0	20.0	7.0	7.0	3.0
Minimum Split (s)	9.0	26.0	26.0	14.0	14.0	9.0
Total Split (s)	23.0	68.0	45.0	32.0	32.0	23.0
Total Split (%)	23.0%	68.0%	45.0%	32.0%	32.0%	23.0%
Maximum Green (s)	17.0	62.0	39.0	25.0	25.0	17.0
Yellow Time (s)	4.0	4.0	4.0	4.0	4.0	4.0
All-Red Time (s)	2.0	2.0	2.0	3.0	3.0	2.0
Lost Time Adjust (s)	-1.0	-1.0	-1.0	-1.0	-1.0	-1.0
Total Lost Time (s)	5.0	5.0	5.0	6.0	6.0	5.0

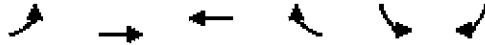

Lane Group	EBL	EBT	WBT	WBR	SEL	SBR
Lead/Lag	Lead		Lag		Lead	
Lead-Lag Optimize?						
Vehicle Extension (s)	3.0	3.0	3.0	3.0	3.0	3.0
Recall Mode	None	C-Max	C-Max	None	None	None
Act Effct Green (s)	69.9	69.9	54.5	78.6	19.1	35.5
Actuated g/C Ratio	0.70	0.70	0.54	0.79	0.19	0.36
v/c Ratio	0.34	0.33	0.37	0.34	0.61	0.25
Control Delay	6.5	5.2	14.8	2.6	40.7	6.8
Queue Delay	0.0	0.0	0.0	0.0	0.0	0.0
Total Delay	6.5	5.2	14.8	2.6	40.7	6.8
LOS	A	A	B	A	D	A
Approach Delay	5.5		10.1	30.8		
Approach LOS	A		B	C		
Queue Length 50th (ft)	24	58	144	42	116	16
Queue Length 95th (ft)	49	93	171	73	152	50
Internal Link Dist (ft)	395		470	890		
Turn Bay Length (ft)	225			210	415	
Base Capacity (vph)	562	2299	1775	1332	858	733
Starvation Cap Reductn	0	0	0	0	0	0
Spillback Cap Reductn	0	0	0	0	0	0
Storage Cap Reductn	0	0	0	0	0	0
Reduced v/c Ratio	0.30	0.33	0.37	0.32	0.45	0.22

Intersection Summary

Area Type: Other
 Cycle Length: 100
 Actuated Cycle Length: 100
 Offset: 38 (38%), Referenced to phase 2:EBTL and 6:WBT, Start of 1st Green
 Natural Cycle: 50
 Control Type: Actuated-Coordinated
 Maximum v/c Ratio: 0.61
 Intersection Signal Delay: 12.8
 Intersection Capacity Utilization 51.1%
 Analysis Period (min): 15
 Intersection LOS: B
 ICU Level of Service A

Splits and Phases: 2: Welsh Road & Dresher Road



BT Dreshertown, LP
 3: Dreshertown Road & Welsh Road

2023 Without SAT Peak



Lane Group	EBT	EBR	WBL	WBT	NBL	NBR
Lane Configurations	↑↑	↑	↑	↑↑	↑↑	↑
Volume (vph)	881	179	262	835	177	311
Ideal Flow (vphpl)	1800	1800	1800	1800	1800	1800
Lane Width (ft)	11	15	10	12	12	15
Grade (%)	-2%			1%	1%	
Storage Length (ft)		150	175		0	350
Storage Lanes		1	1		2	2
Taper Length (ft)			75		75	
Lane Util. Factor	0.95	1.00	1.00	0.95	0.97	1.00
Frt		0.850				0.850
Flt Protected			0.950		0.950	
Satd. Flow (prot)	3339	1683	1588	3403	3301	1675
Flt Permitted			0.216		0.950	
Satd. Flow (perm)	3339	1683	361	3403	3301	1675
Right Turn on Red		Yes				Yes
Satd. Flow (RTOR)		184				70
Link Speed (mph)	45			45	40	
Link Distance (ft)	550			1040	778	
Travel Time (s)	8.3			15.8	13.3	
Peak Hour Factor	0.91	0.91	0.91	0.91	0.91	0.91
Heavy Vehicles (%)	0%	1%	0%	0%	0%	0%
Adj. Flow (vph)	968	197	288	918	195	342
Shared Lane Traffic (%)						
Lane Group Flow (vph)	968	197	288	918	195	342
Number of Detectors	1	1	1	1	1	1
Detector Template						
Leading Detector (ft)	5	5	35	5	35	35
Trailing Detector (ft)	0	0	-5	0	-5	-5
Detector 1 Position(ft)	0	0	-5	0	-5	-5
Detector 1 Size(ft)	5	5	40	5	40	40
Detector 1 Type	CI+Ex	CI+Ex	CI+Ex	CI+Ex	CI+Ex	CI+Ex
Detector 1 Channel						
Detector 1 Extend (s)	0.0	0.0	0.0	0.0	0.0	0.0
Detector 1 Queue (s)	0.0	0.0	0.0	0.0	0.0	0.0
Detector 1 Delay (s)	0.0	0.0	0.0	0.0	0.0	0.0
Turn Type	NA	Perm	pm+pt	NA	Prot	pm+ov
Protected Phases	2		1	6	8	1
Permitted Phases		2	6			8
Detector Phase	2	2	1	6	8	1
Switch Phase						
Minimum Initial (s)	20.0	20.0	3.0	20.0	7.0	3.0
Minimum Split (s)	27.0	27.0	10.0	27.0	14.0	10.0
Total Split (s)	53.0	53.0	29.0	82.0	18.0	29.0
Total Split (%)	53.0%	53.0%	29.0%	82.0%	18.0%	29.0%
Maximum Green (s)	46.0	46.0	22.0	75.0	11.0	22.0
Yellow Time (s)	5.0	5.0	5.0	5.0	4.0	5.0
All-Red Time (s)	2.0	2.0	2.0	2.0	3.0	2.0
Lost Time Adjust (s)	-1.0	-1.0	-1.0	-1.0	-1.0	-1.0
Total Lost Time (s)	6.0	6.0	6.0	6.0	6.0	6.0



Lane Group	EBT	EBR	WBL	WBT	NBL	NBR
Lead/Lag	Lag	Lag	Lead			Lead
Lead-Lag Optimize?						
Vehicle Extension (s)	3.0	3.0	3.0	3.0	3.0	3.0
Recall Mode	C-Max	C-Max	None	C-Max	None	None

Intersection Summary

Area Type: Other
 Cycle Length: 100
 Actuated Cycle Length: 100
 Offset: 28 (28%), Referenced to phase 2:EBT and 6:WBTL, Start of 1st Green
 Natural Cycle: 60
 Control Type: Actuated-Coordinated

Splits and Phases: 3: Dreshertown Road & Welsh Road





Movement	EBT	EBR	WBL	WBT	NBL	NBR
Lane Configurations	↑↑	↑	↑	↑↑	↑↑	↑
Volume (veh/h)	881	179	262	835	177	311
Number	2	12	1	6	3	18
Initial Q (Qb), veh	0	0	0	0	0	0
Ped-Bike Adj(A_pbT)		1.00	1.00		1.00	1.00
Parking Bus, Adj	1.00	1.00	1.00	1.00	1.00	1.00
Adj Sat Flow, veh/h/ln	1818	1872	1791	1791	1791	1863
Adj Flow Rate, veh/h	968	197	288	918	195	256
Adj No. of Lanes	2	1	1	2	2	1
Peak Hour Factor	0.91	0.91	0.91	0.91	0.91	0.91
Percent Heavy Veh, %	0	1	0	0	0	0
Cap, veh/h	2057	948	540	2586	397	355
Arrive On Green	1.00	1.00	0.21	1.00	0.12	0.12
Sat Flow, veh/h	3545	1591	1706	3492	3309	1583
Grp Volume(v), veh/h	968	197	288	918	195	256
Grp Sat Flow(s),veh/h/ln	1727	1591	1706	1701	1655	1583
Q Serve(g_s), s	0.0	0.0	6.2	0.0	5.5	12.0
Cycle Q Clear(g_c), s	0.0	0.0	6.2	0.0	5.5	12.0
Prop In Lane		1.00	1.00		1.00	1.00
Lane Grp Cap(c), veh/h	2057	948	540	2586	397	355
V/C Ratio(X)	0.47	0.21	0.53	0.35	0.49	0.72
Avail Cap(c_a), veh/h	2057	948	754	2586	397	355
HCM Platoon Ratio	2.00	2.00	2.00	2.00	1.00	1.00
Upstream Filter(I)	0.91	0.91	0.94	0.94	1.00	1.00
Uniform Delay (d), s/veh	0.0	0.0	4.1	0.0	41.1	35.9
Incr Delay (d2), s/veh	0.7	0.5	0.8	0.4	0.9	6.9
Initial Q Delay(d3),s/veh	0.0	0.0	0.0	0.0	0.0	0.0
%ile BackOfQ(95%),veh/ln	0.4	0.2	5.1	0.2	4.6	11.6
LnGrp Delay(d),s/veh	0.7	0.5	4.9	0.4	42.1	42.8
LnGrp LOS	A	A	A	A	D	D
Approach Vol, veh/h	1165			1206	451	
Approach Delay, s/veh	0.7			1.4	42.5	
Approach LOS	A			A	D	

Timer	1	2	3	4	5	6	7	8
Assigned Phs	1	2				6		8
Phs Duration (G+Y+Rc), s	16.4	65.6				82.0		18.0
Change Period (Y+Rc), s	7.0	7.0				7.0		7.0
Max Green Setting (Gmax), s	22.0	46.0				75.0		11.0
Max Q Clear Time (g_c+I1), s	8.7	2.5				2.5		14.5
Green Ext Time (p_c), s	0.8	8.4				8.6		0.0

Intersection Summary	
HCM 2010 Ctrl Delay	7.7
HCM 2010 LOS	A

BT Dreshertown, LP
4: Dryden Road & Welsh Road

2023 Without SAT Peak



Lane Group	EBL	EBT	EBR	WBL	WBT	WBR	NBL	NBT	NBR	SBL	SBT	SBR
Lane Configurations	↖	↕	↗	↖	↕	↗	↖	↕	↗	↖	↕	↗
Volume (vph)	2	1130	3	1	1108	2	1	0	1	2	0	2
Ideal Flow (vphpl)	1800	1800	1800	1800	1800	1800	1800	1800	1800	1800	1800	1800
Lane Width (ft)	10	12	14	10	12	12	11	15	15	12	14	14
Grade (%)		-1%			-1%			-1%			0%	
Storage Length (ft)	150		225	175		0	110		0	150		0
Storage Lanes	1		1	1		0	1		0	1		0
Taper Length (ft)	75			75			75			75		
Lane Util. Factor	1.00	0.95	1.00	1.00	0.95	0.95	1.00	1.00	1.00	1.00	1.00	1.00
Frnt			0.850					0.850			0.850	
Flt Protected	0.950			0.950			0.950			0.950		
Satd. Flow (prot)	1604	3437	1640	1604	3437	0	1661	1691	0	1710	1632	0
Flt Permitted	0.222			0.216								
Satd. Flow (perm)	375	3437	1640	365	3437	0	1749	1691	0	1800	1632	0
Right Turn on Red			Yes			Yes			Yes			Yes
Satd. Flow (RTOR)			33		1			138			144	
Link Speed (mph)		45			45			25			25	
Link Distance (ft)		1040			1416			754			960	
Travel Time (s)		15.8			21.5			20.6			26.2	
Peak Hour Factor	0.90	0.90	0.90	0.90	0.90	0.90	0.90	0.90	0.90	0.90	0.90	0.90
Heavy Vehicles (%)	0%	0%	0%	0%	0%	0%	0%	0%	0%	0%	0%	0%
Adj. Flow (vph)	2	1256	3	1	1231	2	1	0	1	2	0	2
Shared Lane Traffic (%)												
Lane Group Flow (vph)	2	1256	3	1	1233	0	1	1	0	2	2	0
Number of Detectors	1	1	1	1	1		1	1		1	1	
Detector Template												
Leading Detector (ft)	5	5	5	5	5		35	35		35	35	
Trailing Detector (ft)	0	0	0	0	0		-5	-5		-5	-5	
Detector 1 Position(ft)	0	0	0	0	0		-5	-5		-5	-5	
Detector 1 Size(ft)	5	5	5	5	5		40	40		40	40	
Detector 1 Type	CI+Ex	CI+Ex	CI+Ex	CI+Ex	CI+Ex		CI+Ex	CI+Ex		CI+Ex	CI+Ex	
Detector 1 Channel												
Detector 1 Extend (s)	0.0	0.0	0.0	0.0	0.0		0.0	0.0		0.0	0.0	
Detector 1 Queue (s)	0.0	0.0	0.0	0.0	0.0		0.0	0.0		0.0	0.0	
Detector 1 Delay (s)	0.0	0.0	0.0	0.0	0.0		0.0	0.0		0.0	0.0	
Turn Type	Perm	NA	Perm	Perm	NA		Perm	NA		Perm	NA	
Protected Phases		2			6			8			4	
Permitted Phases	2		2	6			8			4		
Detector Phase	2	2	2	6	6		8	8		4	4	
Switch Phase												
Minimum Initial (s)	21.0	21.0	21.0	21.0	21.0		5.0	5.0		5.0	5.0	
Minimum Split (s)	27.0	27.0	27.0	27.0	27.0		11.0	11.0		11.0	11.0	
Total Split (s)	85.0	85.0	85.0	85.0	85.0		15.0	15.0		15.0	15.0	
Total Split (%)	85.0%	85.0%	85.0%	85.0%	85.0%		15.0%	15.0%		15.0%	15.0%	
Maximum Green (s)	79.0	79.0	79.0	79.0	79.0		9.0	9.0		9.0	9.0	
Yellow Time (s)	4.0	4.0	4.0	4.0	4.0		3.0	3.0		3.0	3.0	
All-Red Time (s)	2.0	2.0	2.0	2.0	2.0		3.0	3.0		3.0	3.0	
Lost Time Adjust (s)	-1.0	-1.0	-1.0	-1.0	-1.0		-1.0	-1.0		-1.0	-1.0	
Total Lost Time (s)	5.0	5.0	5.0	5.0	5.0		5.0	5.0		5.0	5.0	

BT Dreshertown, LP
 4: Dryden Road & Welsh Road

2023 Without SAT Peak



Lane Group	EBL	EBT	EBR	WBL	WBT	WBR	NBL	NBT	NBR	SBL	SBT	SBR
Lead/Lag												
Lead-Lag Optimize?												
Vehicle Extension (s)	3.0	3.0	3.0	3.0	3.0		3.0	3.0		3.0	3.0	
Recall Mode	C-Max	C-Max	C-Max	C-Max	C-Max		None	None		None	None	

Intersection Summary

Area Type: Other
 Cycle Length: 100
 Actuated Cycle Length: 100
 Offset: 41 (41%), Referenced to phase 2:EBTL and 6:WBTL, Start of 1st Green
 Natural Cycle: 40
 Control Type: Actuated-Coordinated

Splits and Phases: 4: Dryden Road & Welsh Road

p2 (R)	p4
p5 (R)	p8



Movement	EBL	EBT	EBR	WBL	WBT	WBR	NBI	NBT	NBR	SBL	SBT	SBR
Lane Configurations	↖	↕	↗	↖	↕	↗	↖	↕	↗	↖	↕	↗
Volume (veh/h)	2	1130	3	1	1108	2	1	0	1	2	0	2
Number	5	2	12	1	6	16	3	8	18	7	4	14
Initial Q (Qb), veh	0	0	0	0	0	0	0	0	0	0	0	0
Ped-Bike Adj(A_pbT)	1.00		1.00	1.00		1.00	1.00		1.00	1.00		1.00
Parking Bus, Adj	1.00	1.00	1.00	1.00	1.00	1.00	1.00	1.00	1.00	1.00	1.00	1.00
Adj Sat Flow, veh/h/ln	1809	1809	1881	1809	1809	1809	1809	1881	1881	1800	1872	1872
Adj Flow Rate, veh/h	2	1256	1	1	1231	2	1	0	1	2	0	2
Adj No. of Lanes	1	2	1	1	2	0	1	1	0	1	1	0
Peak Hour Factor	0.90	0.90	0.90	0.90	0.90	0.90	0.90	0.90	0.90	0.90	0.90	0.90
Percent Heavy Veh, %	0	0	0	0	0	0	0	0	0	0	0	0
Cap, veh/h	450	3033	1411	470	3107	5	98	0	28	97	0	28
Arrive On Green	1.00	1.00	1.00	0.88	0.88	0.87	0.02	0.00	0.01	0.02	0.00	0.01
Sat Flow, veh/h	461	3437	1599	451	3521	6	1445	0	1599	1439	0	1591
Grp Volume(v), veh/h	2	1256	1	1	601	632	1	0	1	2	0	2
Grp Sat Flow(s),veh/h/ln	461	1719	1599	451	1719	1808	1445	0	1599	1439	0	1591
Q Serve(g_s), s	0.0	0.0	0.0	0.0	6.3	6.3	0.1	0.0	0.1	0.1	0.0	0.1
Cycle Q Clear(g_c), s	6.4	0.0	0.0	0.0	6.3	6.3	0.1	0.0	0.1	0.1	0.0	0.1
Prop In Lane	1.00		1.00	1.00		0.00	1.00		1.00	1.00		1.00
Lane Grp Cap(c), veh/h	450	3033	1411	470	1516	1595	98	0	28	97	0	28
V/C Ratio(X)	0.00	0.41	0.00	0.00	0.40	0.40	0.01	0.00	0.04	0.02	0.00	0.07
Avail Cap(c_a), veh/h	450	3033	1411	470	1516	1595	216	0	160	216	0	159
HCM Platoon Ratio	2.00	2.00	2.00	1.00	1.00	1.00	1.00	1.00	1.00	1.00	1.00	1.00
Upstream Filter(I)	0.83	0.83	0.83	1.00	1.00	1.00	1.00	0.00	1.00	1.00	0.00	1.00
Uniform Delay (d), s/veh	0.2	0.0	0.0	0.7	1.1	1.1	48.3	0.0	48.8	48.3	0.0	48.8
Incr Delay (d2), s/veh	0.0	0.3	0.0	0.0	0.8	0.7	0.0	0.0	0.5	0.1	0.0	1.1
Initial Q Delay(d3),s/veh	0.0	0.0	0.0	0.0	0.0	0.0	0.0	0.0	0.0	0.0	0.0	0.0
%ile BackOfQ(95%),veh/ln	0.0	0.3	0.0	0.0	5.7	6.0	0.1	0.0	0.1	0.1	0.0	0.1
LnGrp Delay(d),s/veh	0.2	0.3	0.0	0.7	1.8	1.8	48.3	0.0	49.3	48.4	0.0	49.9
LnGrp LOS	A	A	A	A	A	A	D		D	D		D
Approach Vol, veh/h		1259			1234			2				4
Approach Delay, s/veh		0.3			1.8			48.8				49.1
Approach LOS		A			A			D				D

Timer	1	2	3	4	5	6	7	8
Assigned Phs		2		4		6		8
Phs Duration (G+Y+Rc), s		93.2		6.8		93.2		6.8
Change Period (Y+Rc), s		6.0		6.0		6.0		6.0
Max Green Setting (Gmax), s		79.0		9.0		79.0		9.0
Max Q Clear Time (g_c+I1), s		8.9		2.6		8.8		2.6
Green Ext Time (p_c), s		10.8		0.0		10.8		0.0

Intersection Summary	
HCM 2010 Ctrl Delay	1.2
HCM 2010 LOS	A

APPENDIX K

**2023 Future with Development
Capacity/Level-of-Service Analysis Worksheets**

BT Dreshertown, LP
 1: Jarrettown Road/Village Road & Welsh Road

2023 With AM Peak



Lane Group	EBL	EBT	EBR	WBL	WBT	WBR	NBL	NBT	NBR	SBL	SBT	SBR
Lane Configurations												
Volume (vph)	58	935	19	308	750	8	19	61	354	9	20	28
Ideal Flow (vphpl)	1800	1800	1800	1800	1800	1800	1800	1800	1800	1800	1800	1800
Lane Width (ft)	12	12	12	11	14	14	12	12	14	15	15	15
Grade (%)		-6%			1%			-1%			1%	
Storage Length (ft)	150		0	100		0	0		175	0		0
Storage Lanes	1		0	1		0	0		1	0		0
Taper Length (ft)	75			75			75			75		
Lane Util. Factor	1.00	0.95	0.95	1.00	1.00	1.00	1.00	1.00	1.00	1.00	1.00	1.00
Frt		0.997			0.998				0.850		0.934	
Flt Protected	0.950			0.950				0.988			0.992	
Satd. Flow (prot)	1727	3440	0	1612	1852	0	0	1760	1640	0	1736	0
Flt Permitted	0.364			0.212				0.916			0.940	
Satd. Flow (perm)	662	3440	0	360	1852	0	0	1632	1640	0	1645	0
Right Turn on Red			Yes			Yes			Yes			Yes
Satd. Flow (RTOR)		2			1				72		29	
Link Speed (mph)		45			45			35			35	
Link Distance (ft)		1263			605			421			431	
Travel Time (s)		19.1			9.2			8.2			8.4	
Peak Hour Factor	0.95	0.95	0.95	0.95	0.95	0.95	0.95	0.95	0.95	0.95	0.95	0.95
Heavy Vehicles (%)	2%	2%	7%	2%	3%	0%	0%	2%	0%	11%	0%	7%
Adj. Flow (vph)	61	984	20	324	789	8	20	64	373	9	21	29
Shared Lane Traffic (%)												
Lane Group Flow (vph)	61	1004	0	324	797	0	0	84	373	0	59	0
Number of Detectors	1	2		1	2		1	1	1	1	1	
Detector Template	Left			Left			Left	Thru	Right	Left	Thru	
Leading Detector (ft)	5	330		35	330		20	35	35	20	35	
Trailing Detector (ft)	0	0		-5	0		0	-5	-5	0	-5	
Detector 1 Position(ft)	0	0		-5	0		0	-5	-5	0	-5	
Detector 1 Size(ft)	5	6		40	6		20	40	40	20	40	
Detector 1 Type	CI+Ex	CI+Ex		CI+Ex	CI+Ex		CI+Ex	CI+Ex	CI+Ex	CI+Ex	CI+Ex	
Detector 1 Channel												
Detector 1 Extend (s)	0.0	0.0		0.0	0.0		0.0	0.0	0.0	0.0	0.0	
Detector 1 Queue (s)	0.0	0.0		0.0	0.0		0.0	0.0	0.0	0.0	0.0	
Detector 1 Delay (s)	0.0	0.0		0.0	0.0		0.0	0.0	0.0	0.0	0.0	
Detector 2 Position(ft)		324			324							
Detector 2 Size(ft)		6			6							
Detector 2 Type		CI+Ex			CI+Ex							
Detector 2 Channel												
Detector 2 Extend (s)		0.0			0.0							
Turn Type	Perm	NA		pm+pt	NA		Perm	NA	pm+ov	Perm	NA	
Protected Phases		2		1	6			8	1		4	
Permitted Phases				6			8		8	4		
Detector Phase	2	2		1	6		8	8	1	4	4	
Switch Phase												
Minimum Initial (s)	15.0	15.0		3.0	15.0		7.0	7.0	3.0	7.0	7.0	
Minimum Split (s)	22.0	22.0		10.0	22.0		13.0	13.0	10.0	13.0	13.0	
Total Split (s)	64.0	64.0		32.0	96.0		24.0	24.0	32.0	24.0	24.0	
Total Split (%)	53.3%	53.3%		26.7%	80.0%		20.0%	20.0%	26.7%	20.0%	20.0%	

BT Dreshertown, LP
 1: Jarrettown Road/Village Road & Welsh Road

2023 With AM Peak

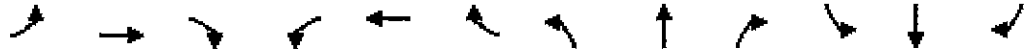

Lane Group	EBL	EBT	EBR	WBL	WBT	WBR	NBL	NBT	NBR	SBL	SBT	SBR
Maximum Green (s)	57.0	57.0		25.0	89.0		18.0	18.0	25.0	18.0	18.0	
Yellow Time (s)	5.0	5.0		5.0	5.0		4.0	4.0	5.0	4.0	4.0	
All-Red Time (s)	2.0	2.0		2.0	2.0		2.0	2.0	2.0	2.0	2.0	
Lost Time Adjust (s)	-1.0	-1.0		-1.0	-1.0			-1.0	-1.0			-1.0
Total Lost Time (s)	6.0	6.0		6.0	6.0			5.0	6.0			5.0
Lead/Lag	Lag	Lag		Lead					Lead			
Lead-Lag Optimize?												
Vehicle Extension (s)	3.0	3.0		3.0	3.0		3.0	3.0	3.0	3.0	3.0	
Recall Mode	C-Max	C-Max		None	C-Max		None	None	None	None	None	None

Intersection Summary

Area Type: Other
 Cycle Length: 120
 Actuated Cycle Length: 120
 Offset: 33 (28%), Referenced to phase 2:EBTL and 6:WBTL, Start of 1st Green
 Natural Cycle: 60
 Control Type: Actuated-Coordinated

Splits and Phases: 1: Jarrettown Road/Village Road & Welsh Road

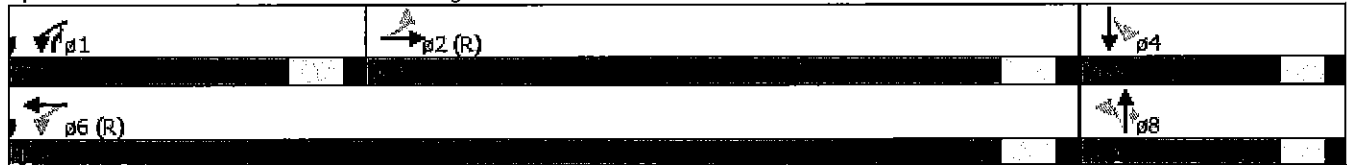

BT Dreshertown, LP
1: Jarretstown Road/Village Road & Welsh Road

2023 With AM Peak



Movement	EBL	EBT	EBR	WBL	WBT	WBR	NEI	NBT	NBR	SBL	SBT	SBR
Lane Configurations												
Volume (veh/h)	58	935	19	308	750	8	19	61	354	9	20	28
Number	5	2	12	1	6	16	3	8	18	7	4	14
Initial Q (Qb), veh	0	0	0	0	0	0	0	0	0	0	0	0
Ped-Bike Adj(A_pbT)	1.00		1.00	1.00		1.00	1.00		1.00	1.00		1.00
Parking Bus, Adj	1.00	1.00	1.00	1.00	1.00	1.00	1.00	1.00	1.00	1.00	1.00	1.00
Adj Sat Flow, veh/h/ln	1818	1816	1854	1756	1809	1863	1809	1782	1881	1863	1772	1863
Adj Flow Rate, veh/h	61	984	18	324	789	7	20	64	346	9	21	27
Adj No. of Lanes	1	2	0	1	1	0	0	1	1	0	1	0
Peak Hour Factor	0.95	0.95	0.95	0.95	0.95	0.95	0.95	0.95	0.95	0.95	0.95	0.95
Percent Heavy Veh, %	2	2	2	2	3	3	2	2	0	0	0	0
Cap, veh/h	450	2066	38	477	1343	12	79	227	419	54	109	116
Arrive On Green	0.60	0.60	0.59	0.10	0.75	0.74	0.15	0.16	0.16	0.15	0.16	0.15
Sat Flow, veh/h	700	3466	63	1672	1790	16	267	1433	1599	123	689	731
Grp Volume(v), veh/h	61	490	512	324	0	796	84	0	346	57	0	0
Grp Sat Flow(s),veh/h/ln	700	1725	1805	1672	0	1806	1700	0	1599	1543	0	0
Q Serve(g_s), s	5.1	19.2	19.2	8.1	0.0	23.6	0.0	0.0	19.0	0.0	0.0	0.0
Cycle Q Clear(g_c), s	9.8	19.2	19.2	8.1	0.0	23.6	5.0	0.0	19.0	3.7	0.0	0.0
Prop In Lane	1.00		0.04	1.00		0.01	0.24		1.00	0.16		0.47
Lane Grp Cap(c), veh/h	450	1028	1076	477	0	1355	292	0	419	266	0	0
V/C Ratio(X)	0.14	0.48	0.48	0.68	0.00	0.59	0.29	0.00	0.83	0.21	0.00	0.00
Avail Cap(c_a), veh/h	450	1028	1076	665	0	1355	292	0	419	266	0	0
HCM Platoon Ratio	1.00	1.00	1.00	1.00	1.00	1.00	1.00	1.00	1.00	1.00	1.00	1.00
Upstream Filter(I)	1.00	1.00	1.00	1.00	0.00	1.00	1.00	0.00	1.00	1.00	0.00	0.00
Uniform Delay (d), s/veh	12.9	13.7	13.7	10.5	0.0	6.7	44.7	0.0	41.7	44.3	0.0	0.0
Incr Delay (d2), s/veh	0.6	1.6	1.5	1.7	0.0	1.9	0.5	0.0	12.7	0.4	0.0	0.0
Initial Q Delay(d3),s/veh	0.0	0.0	0.0	0.0	0.0	0.0	0.0	0.0	0.0	0.0	0.0	0.0
%ile BackOfQ(95%),veh/ln	1.9	14.6	15.2	8.3	0.0	17.9	4.6	0.0	18.0	3.1	0.0	0.0
LnGrp Delay(d),s/veh	13.5	15.2	15.2	12.2	0.0	8.6	45.3	0.0	54.3	44.7	0.0	0.0
LnGrp LOS	B	B	B	B		A	D		D	D		
Approach Vol, veh/h		1063			1120			430				57
Approach Delay, s/veh		15.1			9.6			52.6				44.7
Approach LOS		B			A			D				D

Timer	1	2	3	4	5	6	7	8
Assigned Phs	1	2		4		6		8
Phs Duration (G+Y+Rc), s	18.5	77.5		24.0		96.0		24.0
Change Period (Y+Rc), s	7.0	7.0		6.0		7.0		6.0
Max Green Setting (Gmax), s	25.0	57.0		18.0		89.0		18.0
Max Q Clear Time (g_c+1), s	10.6	21.7		5.7		25.6		21.5
Green Ext Time (p_c), s	0.9	32.0		1.5		53.9		0.0

Intersection Summary	
HCM 2010 Ctrl Delay	19.5
HCM 2010 LOS	B

BT Dreshertown, LP
2: Welsh Road & Dresher Road

2023 With AM Peak



Lane Group	EBL	EBT	WBT	WBR	SBL	SBR
Lane Configurations	↙	↑↑	↑↑	↗	↙↘	↗
Volume (vph)	426	903	797	669	732	320
Ideal Flow (vphpl)	1800	1800	1800	1800	1800	1800
Lane Width (ft)	10	11	11	11	12	13
Grade (%)		-1%	1%		1%	
Storage Length (ft)	225			210	0	415
Storage Lanes	1			1	2	1
Taper Length (ft)	75				75	
Lane Util. Factor	1.00	0.95	0.95	1.00	0.97	1.00
Fr't				0.850		0.850
Flt Protected	0.950				0.950	
Satd. Flow (prot)	1588	3290	3194	1443	3268	1542
Flt Permitted	0.140				0.950	
Satd. Flow (perm)	234	3290	3194	1443	3268	1542
Right Turn on Red				Yes		Yes
Satd. Flow (RTOR)				194		26
Link Speed (mph)		45	45		35	
Link Distance (ft)		475	550		970	
Travel Time (s)		7.2	8.3		18.9	
Peak Hour Factor	0.94	0.94	0.94	0.94	0.94	0.94
Heavy Vehicles (%)	1%	1%	3%	2%	1%	2%
Adj. Flow (vph)	453	961	848	712	779	340
Shared Lane Traffic (%)						
Lane Group Flow (vph)	453	961	848	712	779	340
Number of Detectors	1	1	1	1	1	1
Detector Template						
Leading Detector (ft)	35	5	5	5	35	35
Trailing Detector (ft)	-5	0	0	0	-5	-5
Detector 1 Position(ft)	-5	0	0	0	-5	-5
Detector 1 Size(ft)	40	5	5	5	40	40
Detector 1 Type	CI+Ex	CI+Ex	CI+Ex	CI+Ex	CI+Ex	CI+Ex
Detector 1 Channel						
Detector 1 Extend (s)	0.0	0.0	0.0	0.0	0.0	0.0
Detector 1 Queue (s)	0.0	0.0	0.0	0.0	0.0	0.0
Detector 1 Delay (s)	0.0	0.0	0.0	0.0	0.0	0.0
Turn Type	pm+pt	NA	NA	pm+ov	Prot	pm+ov
Protected Phases	5	2	6	4	4	5
Permitted Phases	2			6		4
Detector Phase	5	2	6	4	4	5
Switch Phase						
Minimum Initial (s)	3.0	20.0	20.0	7.0	7.0	3.0
Minimum Split (s)	9.0	26.0	26.0	14.0	14.0	9.0
Total Split (s)	40.0	82.0	42.0	38.0	38.0	40.0
Total Split (%)	33.3%	68.3%	35.0%	31.7%	31.7%	33.3%
Maximum Green (s)	34.0	76.0	36.0	31.0	31.0	34.0
Yellow Time (s)	4.0	4.0	4.0	4.0	4.0	4.0
All-Red Time (s)	2.0	2.0	2.0	3.0	3.0	2.0
Lost Time Adjust (s)	-1.0	-1.0	-1.0	-1.0	-1.0	-1.0
Total Lost Time (s)	5.0	5.0	5.0	6.0	6.0	5.0

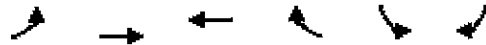

Lane Group	EBL	EBT	WBT	WBR	SBL	SEB
Lead/Lag	Lead		Lag		Lead	
Lead-Lag Optimize?						
Vehicle Extension (s)	3.0	3.0	3.0	3.0	3.0	3.0
Recall Mode	None	C-Max	C-Max	None	None	None
Act Effct Green (s)	77.3	77.3	40.4	77.0	31.7	69.6
Actuated g/C Ratio	0.64	0.64	0.34	0.64	0.26	0.58
v/c Ratio	0.89	0.45	0.79	0.71	0.90	0.38
Control Delay	38.4	11.1	41.7	21.6	57.7	13.2
Queue Delay	0.0	0.2	0.0	0.7	0.0	0.0
Total Delay	38.4	11.2	41.7	22.3	57.7	13.2
LOS	D	B	D	C	E	B
Approach Delay		20.0	32.8		44.2	
Approach LOS		B	C		D	
Queue Length 50th (ft)	268	237	341	347	300	113
Queue Length 95th (ft)	#432	205	#434	64	#408	172
Internal Link Dist (ft)		395	470		890	
Turn Bay Length (ft)	225			210		415
Base Capacity (vph)	546	2120	1074	999	871	944
Starvation Cap Reductn	0	0	0	82	0	0
Spillback Cap Reductn	0	384	0	0	0	0
Storage Cap Reductn	0	0	0	0	0	0
Reduced v/c Ratio	0.83	0.55	0.79	0.78	0.89	0.36

Intersection Summary

Area Type: Other
 Cycle Length: 120
 Actuated Cycle Length: 120
 Offset: 85 (71%), Referenced to phase 2:EBTL and 6:WBT, Start of 1st Green
 Natural Cycle: 90
 Control Type: Actuated-Coordinated
 Maximum v/c Ratio: 0.90
 Intersection Signal Delay: 31.5
 Intersection Capacity Utilization 83.5%
 Analysis Period (min) 15
 # 95th percentile volume exceeds capacity, queue may be longer.
 Queue shown is maximum after two cycles.

Splits and Phases: 2: Welsh Road & Dresher Road



BT Dreshertown, LP
3: Dreshertown Road & Welsh Road

2023 With AM Peak



Lane Group	EBT	EBR	WBL	WBT	NBL	NBR
Lane Configurations	↑↑	↑	↓	↑↑	↑↓	↑
Volume (vph)	1014	621	370	1125	341	327
Ideal Flow (vphpl)	1800	1800	1800	1800	1800	1800
Lane Width (ft)	11	15	10	12	12	15
Grade (%)	-2%			1%	1%	
Storage Length (ft)		150	175		0	350
Storage Lanes		1	1		2	2
Taper Length (ft)			75		75	
Lane Util. Factor	0.95	1.00	1.00	0.95	0.97	1.00
Flt		0.850				0.850
Flt Protected			0.950		0.950	
Satd. Flow (prot)	3306	1650	1542	3304	3174	1626
Flt Permitted			0.154		0.950	
Satd. Flow (perm)	3306	1650	250	3304	3174	1626
Right Turn on Red		Yes				Yes
Satd. Flow (RTOR)		391				26
Link Speed (mph)	45			45	40	
Link Distance (ft)	550			523	600	
Travel Time (s)	8.3			7.9	10.2	
Peak Hour Factor	0.98	0.98	0.98	0.98	0.98	0.98
Heavy Vehicles (%)	1%	3%	3%	3%	4%	3%
Adj. Flow (vph)	1035	634	378	1148	348	334
Shared Lane Traffic (%)						
Lane Group Flow (vph)	1035	634	378	1148	348	334
Number of Detectors	1	1	1	1	1	1
Detector Template						
Leading Detector (ft)	5	5	35	5	35	35
Trailing Detector (ft)	0	0	-5	0	-5	-5
Detector 1 Position(ft)	0	0	-5	0	-5	-5
Detector 1 Size(ft)	5	5	40	5	40	40
Detector 1 Type	CI+Ex	CI+Ex	CI+Ex	CI+Ex	CI+Ex	CI+Ex
Detector 1 Channel						
Detector 1 Extend (s)	0.0	0.0	0.0	0.0	0.0	0.0
Detector 1 Queue (s)	0.0	0.0	0.0	0.0	0.0	0.0
Detector 1 Delay (s)	0.0	0.0	0.0	0.0	0.0	0.0
Turn Type	NA	Perm	pm+pt	NA	Prot	pm+ov
Protected Phases	2		1	6	8	1
Permitted Phases		2	6			8
Detector Phase	2	2	1	6	8	1
Switch Phase						
Minimum Initial (s)	20.0	20.0	3.0	20.0	7.0	3.0
Minimum Split (s)	27.0	27.0	10.0	27.0	14.0	10.0
Total Split (s)	51.0	51.0	45.0	96.0	24.0	45.0
Total Split (%)	42.5%	42.5%	37.5%	80.0%	20.0%	37.5%
Maximum Green (s)	44.0	44.0	38.0	89.0	17.0	38.0
Yellow Time (s)	5.0	5.0	5.0	5.0	4.0	5.0
All-Red Time (s)	2.0	2.0	2.0	2.0	3.0	2.0
Lost Time Adjust (s)	-1.0	-1.0	-1.0	-1.0	-1.0	-1.0
Total Lost Time (s)	6.0	6.0	6.0	6.0	6.0	6.0

BT Dreshertown, LP
 3: Dreshertown Road & Welsh Road

2023 With AM Peak



Lane Group	EBT	EBR	WBL	WBT	NEL	NBR
Lead/Lag	Lag	Lag	Lead			Lead
Lead-Lag Optimize?						
Vehicle Extension (s)	3.0	3.0	3.0	3.0	3.0	3.0
Recall Mode	C-Max	C-Max	None	C-Max	None	None

Intersection Summary

Area Type: Other
 Cycle Length: 120
 Actuated Cycle Length: 120
 Offset: 85 (71%), Referenced to phase 2:EBT and 6:WBTL, Start of 1st Green
 Natural Cycle: 60
 Control Type: Actuated-Coordinated

Splits and Phases: 3: Dreshertown Road & Welsh Road

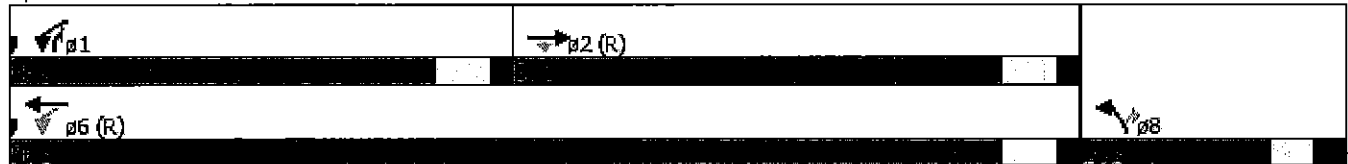

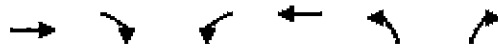

Movement	EBT	EBP	WBL	WBT	NBL	NBR
Lane Configurations	↑↑	↑	↑	↑↑	↑↑	↑
Volume (veh/h)	1014	621	370	1125	341	327
Number	2	12	1	6	3	18
Initial Q (Qb), veh	0	0	0	0	0	0
Ped-Bike Adj(A_pbT)		1.00	1.00		1.00	1.00
Parking Bus, Adj	1.00	1.00	1.00	1.00	1.00	1.00
Adj Sat Flow, veh/h/ln	1800	1836	1739	1739	1722	1808
Adj Flow Rate, veh/h	1035	590	378	1148	348	251
Adj No. of Lanes	2	1	1	2	2	1
Peak Hour Factor	0.98	0.98	0.98	0.98	0.98	0.98
Percent Heavy Veh, %	1	3	3	3	4	3
Cap, veh/h	1922	877	460	2478	477	443
Arrive On Green	1.00	1.00	0.28	1.00	0.15	0.15
Sat Flow, veh/h	3510	1560	1656	3391	3182	1537
Grp Volume(v), veh/h	1035	590	378	1148	348	251
Grp Sat Flow(s),veh/h/ln	1710	1560	1656	1652	1591	1537
Q Serve(g_s), s	0.0	0.0	11.8	0.0	12.5	16.7
Cycle Q Clear(g_c), s	0.0	0.0	11.8	0.0	12.5	16.7
Prop In Lane		1.00	1.00		1.00	1.00
Lane Grp Cap(c), veh/h	1922	877	460	2478	477	443
V/C Ratio(X)	0.54	0.67	0.82	0.46	0.73	0.57
Avail Cap(c_a), veh/h	1922	877	769	2478	477	443
HCM Platoon Ratio	2.00	2.00	2.00	2.00	1.00	1.00
Upstream Filter(l)	0.71	0.71	1.00	1.00	0.90	0.90
Uniform Delay (d), s/veh	0.0	0.0	7.2	0.0	48.7	36.3
Incr Delay (d2), s/veh	0.8	2.9	3.7	0.6	5.0	1.5
Initial Q Delay(d3),s/veh	0.0	0.0	0.0	0.0	0.0	0.0
%ile BackOfQ(95%),veh/ln	0.4	1.3	10.9	0.4	9.6	11.4
LnGrp Delay(d),s/veh	0.8	2.9	10.9	0.6	53.7	37.9
LnGrp LOS	A	A	B	A	D	D
Approach Vol, veh/h	1625			1526	599	
Approach Delay, s/veh	1.6			3.2	47.1	
Approach LOS	A			A	D	

Turner	1	2	3	4	5	6	7	8
Assigned Phs	1	2				6		8
Phs Duration (G+Y+Rc), s	22.6	73.4				96.0		24.0
Change Period (Y+Rc), s	7.0	7.0				7.0		7.0
Max Green Setting (Gmax), s	38.0	44.0				89.0		17.0
Max Q Clear Time (g_c+I1), s	14.3	2.5				2.5		19.2
Green Ext Time (p_c), s	1.3	13.9				15.1		0.0

Intersection Summary	
HCM 2010 Ctrl Delay	9.5
HCM 2010 LOS	A

BT Dreshertown, LP
4: Dryden Road & Welsh Road

2023 With AM Peak



Lane Group	EBL	EBT	EBR	WBL	WBT	WBR	NBL	NBT	NBR	SBL	SBT	SBR
Lane Configurations	↙	↕	↘	↙	↕	↘	↙	↕	↘	↙	↕	↘
Volume (vph)	1	1243	109	206	1454	1	107	0	123	2	0	0
Ideal Flow (vphpl)	1800	1800	1800	1800	1800	1800	1800	1800	1800	1800	1800	1800
Lane Width (ft)	10	12	14	10	12	12	11	15	15	12	14	14
Grade (%)		-1%			-1%			-1%			0%	
Storage Length (ft)	150		225	175		0	110		0	150		0
Storage Lanes	1		1	1		0	1		0	1		0
Taper Length (ft)	75			75			75			75		
Lane Util. Factor	1.00	0.95	1.00	1.00	0.95	0.95	1.00	1.00	1.00	1.00	1.00	1.00
Flt Protected	0.950			0.950			0.950			0.950		
Satd. Flow (prot)	1604	3403	1640	1573	3370	0	1661	1691	0	1710	1920	0
Flt Permitted	0.132			0.178			0.757			0.546		
Satd. Flow (perm)	223	3403	1640	295	3370	0	1324	1691	0	983	1920	0
Right Turn on Red			Yes			Yes			Yes			Yes
Satd. Flow (RTOR)			117					83				
Link Speed (mph)		45			45			25			25	
Link Distance (ft)		517			1416			754			960	
Travel Time (s)		7.8			21.5			20.6			26.2	
Peak Hour Factor	0.93	0.93	0.93	0.93	0.93	0.93	0.93	0.93	0.93	0.93	0.93	0.93
Heavy Vehicles (%)	0%	1%	0%	2%	2%	0%	0%	0%	0%	0%	0%	0%
Adj. Flow (vph)	1	1337	117	222	1563	1	115	0	132	2	0	0
Shared Lane Traffic (%)												
Lane Group Flow (vph)	1	1337	117	222	1564	0	115	132	0	2	0	0
Number of Detectors	1	1	1	1	1		1	1		1	1	
Detector Template												
Leading Detector (ft)	5	5	5	5	5		35	35		35	35	
Trailing Detector (ft)	0	0	0	0	0		-5	-5		-5	-5	
Detector 1 Position (ft)	0	0	0	0	0		-5	-5		-5	-5	
Detector 1 Size (ft)	5	5	5	5	5		40	40		40	40	
Detector 1 Type	CI+Ex	CI+Ex	CI+Ex	CI+Ex	CI+Ex		CI+Ex	CI+Ex		CI+Ex	CI+Ex	
Detector 1 Channel												
Detector 1 Extend (s)	0.0	0.0	0.0	0.0	0.0		0.0	0.0		0.0	0.0	
Detector 1 Queue (s)	0.0	0.0	0.0	0.0	0.0		0.0	0.0		0.0	0.0	
Detector 1 Delay (s)	0.0	0.0	0.0	0.0	0.0		0.0	0.0		0.0	0.0	
Turn Type	Perm	NA	Perm	Perm	NA		Perm	NA		Perm		
Protected Phases		2			6			8				4
Permitted Phases	2		2	6			8			4		
Detector Phase	2	2	2	6	6		8	8		4	4	
Switch Phase												
Minimum Initial (s)	21.0	21.0	21.0	21.0	21.0		5.0	5.0		5.0	5.0	
Minimum Split (s)	27.0	27.0	27.0	27.0	27.0		11.0	11.0		11.0	11.0	
Total Split (s)	88.0	88.0	88.0	88.0	88.0		32.0	32.0		32.0	32.0	
Total Split (%)	73.3%	73.3%	73.3%	73.3%	73.3%		26.7%	26.7%		26.7%	26.7%	
Maximum Green (s)	82.0	82.0	82.0	82.0	82.0		26.0	26.0		26.0	26.0	
Yellow Time (s)	4.0	4.0	4.0	4.0	4.0		3.0	3.0		3.0	3.0	
All-Red Time (s)	2.0	2.0	2.0	2.0	2.0		3.0	3.0		3.0	3.0	
Lost Time Adjust (s)	-1.0	-1.0	-1.0	-1.0	-1.0		-1.0	-1.0		-1.0	-1.0	
Total Lost Time (s)	5.0	5.0	5.0	5.0	5.0		5.0	5.0		5.0	5.0	

BT Dreshertown, LP
 4: Dryden Road & Welsh Road

2023 With AM Peak



Lane Group	EBL	EBT	EBR	WBL	WBT	WBR	NBL	NBT	NBR	SBL	SBT	SBR
Lead/Lag												
Lead-Lag Optimize?												
Vehicle Extension (s)	3.0	3.0	3.0	3.0	3.0		3.0	3.0		3.0	3.0	
Recall Mode	C-Max	C-Max	C-Max	C-Max	C-Max		None	None		None	None	

Intersection Summary

Area Type: Other
 Cycle Length: 120
 Actuated Cycle Length: 120
 Offset: 62 (52%), Referenced to phase 2:EBTL and 6:WBTL, Start of 1st Green
 Natural Cycle: 80
 Control Type: Actuated-Coordinated

Splits and Phases: 4: Dryden Road & Welsh Road

p2 (R)	p4
p6 (R)	p8

BT Dreshertown, LP
4: Dryden Road & Welsh Road

2023 With AM Peak



Movement	ESL	EBT	EBR	WBL	WBT	WBR	NBL	NBT	NBR	SBL	SBT	SBR
Lane Configurations	↖	↕	↗	↖	↕	↗	↖	↕	↗	↖	↕	↗
Volume (veh/h)	1	1243	109	206	1454	1	107	0	123	2	0	0
Number	5	2	12	1	6	16	3	8	18	7	4	14
Initial Q (Qb), veh	0	0	0	0	0	0	0	0	0	0	0	0
Ped-Bike Adj(A_pbT)	1.00		1.00	1.00		1.00	1.00		1.00	1.00		1.00
Parking Bus, Adj	1.00	1.00	1.00	1.00	1.00	1.00	1.00	1.00	1.00	1.00	1.00	1.00
Adj Sat Flow, veh/h/ln	1809	1791	1881	1774	1774	1809	1809	1881	1881	1800	1872	1872
Adj Flow Rate, veh/h	1	1337	115	222	1563	1	115	0	132	2	0	0
Adj No. of Lanes	1	2	1	1	2	0	1	1	0	1	1	0
Peak Hour Factor	0.93	0.93	0.93	0.93	0.93	0.93	0.93	0.93	0.93	0.93	0.93	0.93
Percent Heavy Veh, %	0	1	0	2	2	2	0	0	0	0	0	0
Cap, veh/h	276	2736	1286	355	2779	2	223	0	180	107	211	0
Arrive On Green	1.00	1.00	1.00	0.80	0.80	0.80	0.11	0.00	0.10	0.11	0.00	0.00
Sat Flow, veh/h	336	3403	1599	367	3456	2	1447	0	1599	1278	1872	0
Grp Volume(v), veh/h	1	1337	115	222	762	802	115	0	132	2	0	0
Grp Sat Flow(s),veh/h/ln	336	1702	1599	367	1685	1773	1447	0	1599	1278	1872	0
Q Serve(g_s), s	0.1	0.0	0.0	36.1	19.4	19.4	9.2	0.0	9.6	0.2	0.0	0.0
Cycle Q Clear(g_c), s	19.5	0.0	0.0	36.1	19.4	19.4	9.2	0.0	9.6	9.3	0.0	0.0
Prop In Lane	1.00		1.00	1.00		0.00	1.00		1.00	1.00		0.00
Lane Grp Cap(c), veh/h	276	2736	1286	355	1355	1426	223	0	180	107	211	0
V/C Ratio(X)	0.00	0.49	0.09	0.63	0.56	0.56	0.52	0.00	0.73	0.02	0.00	0.00
Avail Cap(c_a), veh/h	276	2736	1286	355	1355	1426	386	0	360	251	421	0
HCM Platoon Ratio	2.00	2.00	2.00	1.00	1.00	1.00	1.00	1.00	1.00	1.00	1.00	1.00
Upstream Filter(I)	1.00	1.00	1.00	1.00	1.00	1.00	1.00	0.00	1.00	1.00	0.00	0.00
Uniform Delay (d), s/veh	2.0	0.0	0.0	5.8	4.2	4.2	51.3	0.0	52.0	55.8	0.0	0.0
Incr Delay (d2), s/veh	0.0	0.6	0.1	8.1	1.7	1.6	1.8	0.0	5.7	0.1	0.0	0.0
Initial Q Delay(d3),s/veh	0.0	0.0	0.0	0.0	0.0	0.0	0.0	0.0	0.0	0.0	0.0	0.0
%ile BackOfQ(95%),veh/ln	0.0	0.4	0.1	7.8	14.6	15.2	6.8	0.0	8.0	0.1	0.0	0.0
LnGrp Delay(d),s/veh	2.0	0.6	0.1	13.9	5.9	5.8	53.2	0.0	57.6	55.8	0.0	0.0
LnGrp LOS	A	A	A	B	A	A	D		E	E		
Approach Vol, veh/h		1453			1786			247			2	
Approach Delay, s/veh		0.6			6.9			55.6			55.8	
Approach LOS		A			A			E			E	

Timer	1	2	3	4	5	6	7	8
Assigned Phs		2		4		6		8
Phs Duration (G+Y+Rc), s		101.5		18.5		101.5		18.5
Change Period (Y+Rc), s		6.0		6.0		6.0		6.0
Max Green Setting (Gmax), s		82.0		26.0		82.0		26.0
Max Q Clear Time (g_c+1), s		22.0		11.8		38.6		11.7
Green Ext Time (p_c), s		26.3		0.7		23.0		0.7

Intersection Summary	
HCM 2010 Ctrl Delay	7.7
HCM 2010 LOS	A

BT Dreshertown, LP
5: Dreshertown Road & Dryden Road

2023 With AM Peak



Lane Group	WBL	WBR	NBT	NBR	SBL	SBT
Lane Configurations	↙	↘	↑	↗	↙	↗
Volume (vph)	134	52	617	116	65	927
Ideal Flow (vphpl)	1800	1800	1800	1800	1800	1800
Lane Width (ft)	12	14	12	14	12	12
Grade (%)	0%		1%			0%
Storage Length (ft)	0	200		225	175	
Storage Lanes	1	1		1	1	
Taper Length (ft)	75				75	
Lane Util. Factor	1.00	1.00	1.00	1.00	1.00	1.00
Frt		0.850		0.850		
Flt Protected	0.950				0.950	
Satd. Flow (prot)	1676	1600	1739	1592	1676	1748
Flt Permitted	0.950				0.385	
Satd. Flow (perm)	1676	1600	1739	1592	679	1748
Right Turn on Red		Yes		Yes		
Satd. Flow (RTOR)		53		118		
Link Speed (mph)	25		40			40
Link Distance (ft)	593		426			600
Travel Time (s)	16.2		7.3			10.2
Peak Hour Factor	0.98	0.98	0.98	0.98	0.98	0.98
Heavy Vehicles (%)	2%	2%	3%	2%	2%	3%
Adj. Flow (vph)	137	53	630	118	66	946
Shared Lane Traffic (%)						
Lane Group Flow (vph)	137	53	630	118	66	946
Number of Detectors	1	1	1	1	1	1
Detector Template	Left	Right	Thru	Right	Left	Thru
Leading Detector (ft)	35	35	5	5	35	5
Trailing Detector (ft)	-5	-5	0	0	-5	0
Detector 1 Position(ft)	-5	-5	0	0	-5	0
Detector 1 Size(ft)	40	40	5	5	40	5
Detector 1 Type	Cl+Ex	Cl+Ex	Cl+Ex	Cl+Ex	Cl+Ex	Cl+Ex
Detector 1 Channel						
Detector 1 Extend (s)	0.0	0.0	0.0	0.0	0.0	0.0
Detector 1 Queue (s)	0.0	0.0	0.0	0.0	0.0	0.0
Detector 1 Delay (s)	0.0	0.0	0.0	0.0	0.0	0.0
Turn Type	Prot	Perm	NA	Perm	Perm	NA
Protected Phases	8		2			6
Permitted Phases		8		2	6	
Detector Phase	8	8	2	2	6	6
Switch Phase						
Minimum Initial (s)	15.0	15.0	20.0	20.0	20.0	20.0
Minimum Split (s)	21.0	21.0	26.0	26.0	26.0	26.0
Total Split (s)	21.0	21.0	99.0	99.0	99.0	99.0
Total Split (%)	17.5%	17.5%	82.5%	82.5%	82.5%	82.5%
Maximum Green (s)	15.0	15.0	93.0	93.0	93.0	93.0
Yellow Time (s)	4.0	4.0	4.0	4.0	4.0	4.0
All-Red Time (s)	2.0	2.0	2.0	2.0	2.0	2.0
Lost Time Adjust (s)	-1.0	-1.0	-1.0	-1.0	-1.0	-1.0
Total Lost Time (s)	5.0	5.0	5.0	5.0	5.0	5.0

BT Dreshertown, LP
 5: Dreshertown Road & Dryden Road

2023 With AM Peak



Lane Group	WBL	WBR	NBT	NBP	SBL	SBT
Lead/Lag						
Lead-Lag Optimize?						
Vehicle Extension (s)	3.0	3.0	3.0	3.0	3.0	3.0
Recall Mode	None	None	C-Max	C-Max	C-Max	C-Max

Intersection Summary
 Area Type: Other
 Cycle Length: 120
 Actuated Cycle Length: 120
 Offset: 116 (97%), Referenced to phase 2:NBT and 6:SBTL, Start of 1st Green
 Natural Cycle: 65
 Control Type: Actuated-Coordinated

Splits and Phases: 5: Dreshertown Road & Dryden Road

<p>02 (R)</p>	
<p>06 (R)</p>	<p>08</p>



Measurement	WBL	WBR	NBT	NBR	SBL	SBT
Lane Configurations	↖	↗	↑	↑	↖	↗
Volume (veh/h)	134	52	617	116	65	927
Number	3	18	2	12	1	6
Initial Q (Qb), veh	0	0	0	0	0	0
Ped-Bike Adj(A_pbT)	1.00	1.00		1.00	1.00	
Parking Bus, Adj	1.00	1.00	1.00	1.00	1.00	1.00
Adj Sat Flow, veh/h/ln	1765	1835	1739	1826	1765	1748
Adj Flow Rate, veh/h	137	53	630	118	66	946
Adj No. of Lanes	1	1	1	1	1	1
Peak Hour Factor	0.98	0.98	0.98	0.98	0.98	0.98
Percent Heavy Veh, %	2	2	3	2	2	3
Cap, veh/h	224	208	1362	1216	529	1369
Arrive On Green	0.13	0.13	0.78	0.78	0.78	0.78
Sat Flow, veh/h	1681	1560	1739	1552	711	1748
Grp Volume(v), veh/h	137	53	630	118	66	946
Grp Sat Flow(s),veh/h/ln	1681	1560	1739	1552	711	1748
Q Serve(g_s), s	9.2	3.7	14.8	2.1	4.2	30.7
Cycle Q Clear(g_c), s	9.2	3.7	14.8	2.1	18.9	30.7
Prop In Lane	1.00	1.00		1.00	1.00	
Lane Grp Cap(c), veh/h	224	208	1362	1216	529	1369
V/C Ratio(X)	0.61	0.26	0.46	0.10	0.12	0.69
Avail Cap(c_a), veh/h	224	208	1362	1216	529	1369
HCM Platoon Ratio	1.00	1.00	1.00	1.00	1.00	1.00
Upstream Filter(I)	1.00	1.00	1.00	1.00	0.66	0.66
Uniform Delay (d), s/veh	49.1	46.7	4.4	3.0	7.6	6.1
Incr Delay (d2), s/veh	4.8	0.6	1.1	0.2	0.3	1.9
Initial Q Delay(d3),s/veh	0.0	0.0	0.0	0.0	0.0	0.0
%ile BackOfQ(95%),veh/ln	8.1	2.9	11.9	1.7	1.5	20.4
LnGrp Delay(d),s/veh	53.9	47.3	5.5	3.2	7.9	8.1
LnGrp LOS	D	D	A	A	A	A
Approach Vol, veh/h	190		748			1012
Approach Delay, s/veh	52.1		5.2			8.0
Approach LOS	D		A			A

Time	1	2	3	4	5	6	7	8
Assigned Phs		2				6		8
Phs Duration (G+Y+Rc), s		99.0				99.0		21.0
Change Period (Y+Rc), s		6.0				6.0		6.0
Max Green Setting (Gmax), s		93.0				93.0		15.0
Max Q Clear Time (g_c+l1), s		17.3				33.2		11.7
Green Ext Time (p_c), s		6.8				6.8		0.2

Intersection Summary	
HCM 2010 Ctrl Delay	11.2
HCM 2010 LOS	B



Lane Group	EBT	EBR	WBL	WBT	NBL	NBR
Lane Configurations	↑↑	↗		↑↑		↗
Volume (vph)	1306	46	0	1561	0	52
Ideal Flow (vphpl)	1800	1800	1800	1800	1800	1800
Lane Width (ft)	12	14	12	12	12	12
Grade (%)	-1%			1%	0%	
Storage Length (ft)		225	0		0	0
Storage Lanes		1	0		0	1
Taper Length (ft)			75		75	
Lane Util. Factor	0.95	1.00	1.00	0.95	1.00	1.00
Frt		0.850				0.865
Flt Protected						
Satd. Flow (prot)	3403	1608	0	3336	0	1526
Flt Permitted						
Satd. Flow (perm)	3403	1608	0	3336	0	1526
Link Speed (mph)	45			45	25	
Link Distance (ft)	523			517	307	
Travel Time (s)	7.9			7.8	8.4	
Peak Hour Factor	0.90	0.90	0.90	0.90	0.90	0.90
Heavy Vehicles (%)	1%	2%	0%	2%	0%	2%
Adj. Flow (vph)	1451	51	0	1734	0	58
Shared Lane Traffic (%)						
Lane Group Flow (vph)	1451	51	0	1734	0	58
Sign Control	Free			Free	Stop	

Intersection Summary

Area Type: Other
Control Type: Unsignalized

Intersection

Int Delay, s/veh 0.3

Movement	EBT	EBR	WBL	WBT	NBL	NBR
Vol, veh/h	1306	46	0	1561	0	52
Conflicting Peds, #/hr	0	0	0	0	0	0
Sign Control	Free	Free	Free	Free	Stop	Stop
RT Channelized	-	None	-	None	-	None
Storage Length	-	225	-	-	-	0
Veh in Median Storage, #	0	-	-	0	0	-
Grade, %	-1	-	-	1	0	-
Peak Hour Factor	90	90	90	90	90	90
Heavy Vehicles, %	1	2	0	2	0	2
Mvmt Flow	1451	51	0	1734	0	58

Major/Minor	Major1	Major2	Minor1	Minor2
Conflicting Flow All	0	0	1451	0
Stage 1	-	-	-	-
Stage 2	-	-	-	-
Critical Hdwy	-	-	4.1	-
Critical Hdwy Stg 1	-	-	-	-
Critical Hdwy Stg 2	-	-	-	-
Follow-up Hdwy	-	-	2.2	-
Pot Cap-1 Maneuver	-	-	473	-
Stage 1	-	-	-	-
Stage 2	-	-	-	-
Platoon blocked, %	-	-	-	-
Mov Cap-1 Maneuver	-	-	473	-
Mov Cap-2 Maneuver	-	-	-	-
Stage 1	-	-	-	-
Stage 2	-	-	-	-

Approach	EB	WB	NB
HCM Control Delay, s	0	0	16
HCM LOS			C

Minor Lane/Minor Mvmt	NBLn1	EBT	EBR	WBL	WBT
Capacity (veh/h)	384	-	-	473	-
HCM Lane V/C Ratio	0.15	-	-	-	-
HCM Control Delay (s)	16	-	-	0	-
HCM Lane LOS	C	-	-	A	-
HCM 95th %tile Q(veh)	0.5	-	-	0	-

1: Jarrettown Road/Village Road & Welsh Road



Lane Group	EBL	EBT	EBR	WBL	WBT	WBR	NBL	NBT	NBR	SBL	SBT	SBR
Lane Configurations	↙	↕		↙	↕			↕	↗		↕	
Volume (vph)	22	896	30	285	1069	15	22	21	288	42	94	108
Ideal Flow (vphpl)	1800	1800	1800	1800	1800	1800	1800	1800	1800	1800	1800	1800
Lane Width (ft)	12	12	12	11	14	14	12	12	14	15	15	15
Grade (%)		-6%			1%			-1%			1%	
Storage Length (ft)	150		0	100		0	0		175	0		0
Storage Lanes	1		0	1		0	0		1	0		0
Taper Length (ft)	75			75			75			75		
Lane Util. Factor	1.00	0.95	0.95	1.00	1.00	1.00	1.00	1.00	1.00	1.00	1.00	1.00
Frt		0.995			0.998				0.850		0.940	
Flt Protected	0.950			0.950				0.975			0.991	
Satd. Flow (prot)	1761	3471	0	1645	1907	0	0	1764	1640	0	1826	0
Flt Permitted	0.165			0.201				0.632			0.935	
Satd. Flow (perm)	306	3471	0	348	1907	0	0	1143	1640	0	1723	0
Right Turn on Red			Yes			Yes			Yes			Yes
Satd. Flow (RTOR)		3			1				41		30	
Link Speed (mph)		45			45			35			35	
Link Distance (ft)		1263			605			421			431	
Travel Time (s)		19.1			9.2			8.2			8.4	
Peak Hour Factor	0.96	0.96	0.96	0.96	0.96	0.96	0.96	0.96	0.96	0.96	0.96	0.96
Heavy Vehicles (%)	0%	1%	0%	0%	0%	0%	0%	0%	0%	3%	0%	0%
Adj. Flow (vph)	23	933	31	297	1114	16	23	22	300	44	98	112
Shared Lane Traffic (%)												
Lane Group Flow (vph)	23	964	0	297	1130	0	0	45	300	0	254	0
Number of Detectors	1	2		1	2		1	1	1	1	1	
Detector Template	Left			Left			Left	Thru	Right	Left	Thru	
Leading Detector (ft)	5	330		35	330		20	35	35	20	35	
Trailing Detector (ft)	0	0		-5	0		0	-5	-5	0	-5	
Detector 1 Position(ft)	0	0		-5	0		0	-5	-5	0	-5	
Detector 1 Size(ft)	5	6		40	6		20	40	40	20	40	
Detector 1 Type	CI+Ex	CI+Ex		CI+Ex	CI+Ex		CI+Ex	CI+Ex	CI+Ex	CI+Ex	CI+Ex	
Detector 1 Channel												
Detector 1 Extend (s)	0.0	0.0		0.0	0.0		0.0	0.0	0.0	0.0	0.0	
Detector 1 Queue (s)	0.0	0.0		0.0	0.0		0.0	0.0	0.0	0.0	0.0	
Detector 1 Delay (s)	0.0	0.0		0.0	0.0		0.0	0.0	0.0	0.0	0.0	
Detector 2 Position(ft)		324			324							
Detector 2 Size(ft)		6			6							
Detector 2 Type		CI+Ex			CI+Ex							
Detector 2 Channel												
Detector 2 Extend (s)		0.0			0.0							
Turn Type	Perm	NA		pm+pt	NA		Perm	NA	pm+ov	Perm	NA	
Protected Phases		2		1	6			8	1		4	
Permitted Phases	2			6			8		8	4		
Detector Phase	2	2		1	6		8	8	1	4	4	
Switch Phase												
Minimum Initial (s)	15.0	15.0		3.0	15.0		7.0	7.0	3.0	7.0	7.0	
Minimum Split (s)	22.0	22.0		10.0	22.0		13.0	13.0	10.0	13.0	13.0	
Total Split (s)	52.0	52.0		37.0	89.0		31.0	31.0	37.0	31.0	31.0	
Total Split (%)	43.3%	43.3%		30.8%	74.2%		25.8%	25.8%	30.8%	25.8%	25.8%	

1: Jarrettown Road/Village Road & Welsh Road



Lane Group	EBL	EBT	EBR	WBL	WBT	WBR	NBL	NBT	NBR	SBL	SBT	SBR
Maximum Green (s)	45.0	45.0		30.0	82.0		25.0	25.0	30.0	25.0	25.0	
Yellow Time (s)	5.0	5.0		5.0	5.0		4.0	4.0	5.0	4.0	4.0	
All-Red Time (s)	2.0	2.0		2.0	2.0		2.0	2.0	2.0	2.0	2.0	
Lost Time Adjust (s)	-1.0	-1.0		-1.0	-1.0			-1.0	-1.0			-1.0
Total Lost Time (s)	6.0	6.0		6.0	6.0			5.0	6.0			5.0
Lead/Lag	Lag	Lag		Lead					Lead			
Lead-Lag Optimize?												
Vehicle Extension (s)	3.0	3.0		3.0	3.0		3.0	3.0	3.0	3.0	3.0	
Recall Mode	C-Max	C-Max		None	C-Max		None	None	None	None	None	

Intersection Summary

Area Type: Other
 Cycle Length: 120
 Actuated Cycle Length: 120
 Offset: 3 (3%), Referenced to phase 2:EBTL and 6:WBTL, Start of 1st Green
 Natural Cycle: 60
 Control Type: Actuated-Coordinated

Splits and Phases: 1: Jarrettown Road/Village Road & Welsh Road

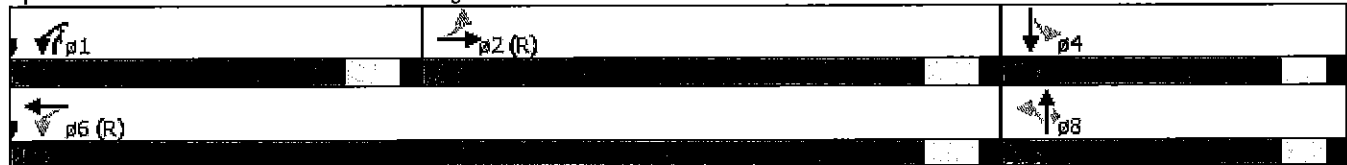



Movement	EBL	EBT	EBR	WBL	WBT	WBR	NBL	NBT	NBR	SBL	SBT	SBR
Lane Configurations	↖	↕		↖	↕			↕	↗		↕	
Volume (veh/h)	22	896	30	285	1069	15	22	21	288	42	94	108
Number	5	2	12	1	6	16	3	8	18	7	4	14
Initial Q (Qb), veh	0	0	0	0	0	0	0	0	0	0	0	0
Ped-Bike Adj(A_pbT)	1.00		1.00	1.00		1.00	1.00		1.00	1.00		1.00
Parking Bus, Adj	1.00	1.00	1.00	1.00	1.00	1.00	1.00	1.00	1.00	1.00	1.00	1.00
Adj Sat Flow, veh/h/ln	1854	1836	1854	1791	1863	1863	1809	1809	1881	1863	1853	1863
Adj Flow Rate, veh/h	23	933	30	297	1114	15	23	22	279	44	98	98
Adj No. of Lanes	1	2	0	1	1	0	0	1	1	0	1	0
Peak Hour Factor	0.96	0.96	0.96	0.96	0.96	0.96	0.96	0.96	0.96	0.96	0.96	0.96
Percent Heavy Veh, %	0	1	1	0	0	0	0	0	0	0	0	0
Cap, veh/h	213	1963	63	475	1321	18	132	113	463	76	137	122
Arrive On Green	0.57	0.57	0.56	0.10	0.72	0.71	0.18	0.19	0.19	0.18	0.19	0.18
Sat Flow, veh/h	522	3450	111	1706	1834	25	460	601	1599	216	729	653
Grp Volume(v), veh/h	23	472	491	297	0	1129	45	0	279	240	0	0
Grp Sat Flow(s),veh/h/ln	522	1744	1817	1706	0	1858	1061	0	1599	1599	0	0
Q Serve(g_s), s	3.9	19.2	19.2	7.8	0.0	51.9	0.0	0.0	18.0	12.0	0.0	0.0
Cycle Q Clear(g_c), s	37.1	19.2	19.2	7.8	0.0	51.9	3.2	0.0	18.0	17.3	0.0	0.0
Prop In Lane	1.00		0.06	1.00		0.01	0.51		1.00	0.18		0.41
Lane Grp Cap(c), veh/h	213	992	1034	475	0	1339	236	0	463	322	0	0
V/C Ratio(X)	0.11	0.48	0.48	0.63	0.00	0.84	0.19	0.00	0.60	0.74	0.00	0.00
Avail Cap(c_a), veh/h	213	992	1034	742	0	1339	278	0	509	367	0	0
HCM Platoon Ratio	1.00	1.00	1.00	1.00	1.00	1.00	1.00	1.00	1.00	1.00	1.00	1.00
Upstream Filter(I)	1.00	1.00	1.00	1.00	0.00	1.00	1.00	0.00	1.00	1.00	0.00	0.00
Uniform Delay (d), s/veh	31.4	15.3	15.3	10.9	0.0	11.9	40.9	0.0	36.7	46.7	0.0	0.0
Incr Delay (d2), s/veh	1.0	1.6	1.6	1.4	0.0	6.6	0.4	0.0	1.7	7.0	0.0	0.0
Initial Q Delay(d3),s/veh	0.0	0.0	0.0	0.0	0.0	0.0	0.0	0.0	0.0	0.0	0.0	0.0
%ile BackOfQ(95%),veh/ln	1.1	14.7	15.2	6.9	0.0	37.6	2.3	0.0	12.8	13.1	0.0	0.0
LnGrp Delay(d),s/veh	32.5	16.9	16.9	12.2	0.0	18.5	41.3	0.0	38.4	53.7	0.0	0.0
LnGrp LOS	C	B	B	B		B	D		D	D		
Approach Vol, veh/h		986			1426			324			240	
Approach Delay, s/veh		17.3			17.2			38.8			53.7	
Approach LOS		B			B			D			D	

Timer	1	2	3	4	5	6	7	8
Assigned Phs	1	2		4		6		8
Phs Duration (G+Y+Rc), s	18.2	74.3		27.5		92.5		27.5
Change Period (Y+Rc), s	7.0	7.0		6.0		7.0		6.0
Max Green Setting (Gmax), s	30.0	45.0		25.0		82.0		25.0
Max Q Clear Time (g_c+I1), s	10.3	39.6		19.3		53.9		20.5
Green Ext Time (p_c), s	0.9	5.3		1.2		27.3		1.0

Intersection Summary	
HCM 2010 Ctrl Delay	22.5
HCM 2010 LOS	C

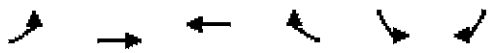

Lane Group	EBL	EBT	WBT	WBR	SBL	SBR
Lane Configurations	↖	↕	↕	↗	↖	↗
Volume (vph)	315	968	1008	660	965	426
Ideal Flow (vphpl)	1800	1800	1800	1800	1800	1800
Lane Width (ft)	10	11	11	11	12	13
Grade (%)		-1%	1%		1%	
Storage Length (ft)	225			210	0	415
Storage Lanes	1			1	2	1
Taper Length (ft)	75				75	
Lane Util. Factor	1.00	0.95	0.95	1.00	0.97	1.00
Friction				0.850		0.850
Flt Protected	0.950				0.950	
Satd. Flow (prot)	1588	3257	3257	1457	3268	1558
Flt Permitted	0.085				0.950	
Satd. Flow (perm)	142	3257	3257	1457	3268	1558
Right Turn on Red				Yes		Yes
Satd. Flow (RTOR)				181		16
Link Speed (mph)		45	45		35	
Link Distance (ft)		475	550		970	
Travel Time (s)		7.2	8.3		18.9	
Peak Hour Factor	0.95	0.95	0.95	0.95	0.95	0.95
Heavy Vehicles (%)	1%	2%	1%	1%	1%	1%
Adj. Flow (vph)	332	1019	1061	695	1016	448
Shared Lane Traffic (%)						
Lane Group Flow (vph)	332	1019	1061	695	1016	448
Number of Detectors	1	1	1	1	1	1
Detector Template						
Leading Detector (ft)	35	5	5	5	35	35
Trailing Detector (ft)	-5	0	0	0	-5	-5
Detector 1 Position(ft)	-5	0	0	0	-5	-5
Detector 1 Size(ft)	40	5	5	5	40	40
Detector 1 Type	Cl+Ex	Cl+Ex	Cl+Ex	Cl+Ex	Cl+Ex	Cl+Ex
Detector 1 Channel						
Detector 1 Extend (s)	0.0	0.0	0.0	0.0	0.0	0.0
Detector 1 Queue (s)	0.0	0.0	0.0	0.0	0.0	0.0
Detector 1 Delay (s)	0.0	0.0	0.0	0.0	0.0	0.0
Turn Type	pm+pt	NA	NA	pm+ov	Prot	pm+ov
Protected Phases	5	2	6	4	4	5
Permitted Phases	2			6		4
Detector Phase	5	2	6	4	4	5
Switch Phase						
Minimum Initial (s)	3.0	20.0	20.0	7.0	7.0	3.0
Minimum Split (s)	9.0	26.0	26.0	14.0	14.0	9.0
Total Split (s)	30.0	76.0	46.0	44.0	44.0	30.0
Total Split (%)	25.0%	63.3%	38.3%	36.7%	36.7%	25.0%
Maximum Green (s)	24.0	70.0	40.0	37.0	37.0	24.0
Yellow Time (s)	4.0	4.0	4.0	4.0	4.0	4.0
All-Red Time (s)	2.0	2.0	2.0	3.0	3.0	2.0
Lost Time Adjust (s)	-1.0	-1.0	-1.0	-1.0	-1.0	-1.0
Total Lost Time (s)	5.0	5.0	5.0	6.0	6.0	5.0

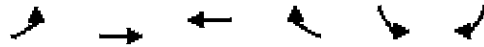

Lane Group	EBL	EPT	WBT	WBR	SBL	SEB
Lead/Lag	Lead		Lag		Lead	
Lead-Lag Optimize?						
Vehicle Extension (s)	3.0	3.0	3.0	3.0	3.0	3.0
Recall Mode	None	C-Max	C-Max	None	None	None
Act Effct Green (s)	71.0	71.0	42.3	85.3	38.0	67.7
Actuated g/C Ratio	0.59	0.59	0.35	0.71	0.32	0.56
v/c Ratio	0.90	0.53	0.92	0.64	0.98	0.51
Control Delay	54.3	21.3	46.5	7.2	65.1	17.5
Queue Delay	0.0	0.4	0.7	0.4	0.0	0.1
Total Delay	54.3	21.7	47.2	7.6	65.1	17.6
LOS	D	C	D	A	E	B
Approach Delay		29.7	31.6		50.6	
Approach LOS		C	C		D	
Queue Length 50th (ft)	215	324	343	150	401	189
Queue Length 95th (ft)	#367	398	m#526	m199	#544	276
Internal Link Dist (ft)		395	470		890	
Turn Bay Length (ft)	225			210		415
Base Capacity (vph)	385	1927	1148	1088	1034	902
Starvation Cap Reductn	0	0	13	99	0	0
Spillback Cap Reductn	0	388	0	0	0	64
Storage Cap Reductn	0	0	0	0	0	0
Reduced v/c Ratio	0.86	0.66	0.93	0.70	0.98	0.53

Intersection Summary

Area Type: Other
 Cycle Length: 120
 Actuated Cycle Length: 120
 Offset: 77 (64%), Referenced to phase 2:EBTL and 6:WBT, Start of 1st Green
 Natural Cycle: 90
 Control Type: Actuated-Coordinated
 Maximum v/c Ratio: 0.98
 Intersection Signal Delay: 37.1
 Intersection Capacity Utilization 90.2%
 Analysis Period (min) 15
 # 95th percentile volume exceeds capacity, queue may be longer.
 Queue shown is maximum after two cycles.
 m Volume for 95th percentile queue is metered by upstream signal.

Intersection LOS: D
 ICU Level of Service E

Splits and Phases: 2: Welsh Road & Dresher Road

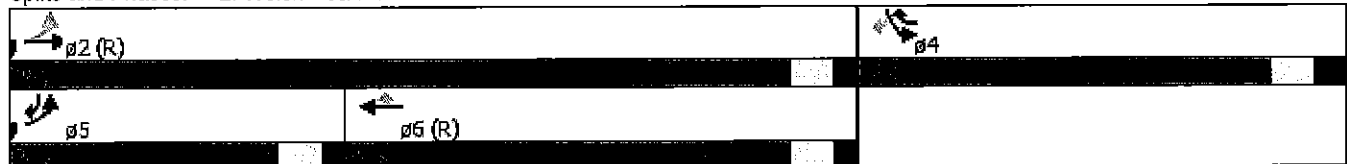



Lane Group	EBT	EBR	WBL	WBT	NBL	NBR
Lane Configurations	↑↑	↑	↓	↑↑	↓↓	↑
Volume (vph)	1277	656	401	1172	495	400
Ideal Flow (vphpl)	1800	1800	1800	1800	1800	1800
Lane Width (ft)	11	15	10	12	12	15
Grade (%)	-2%			1%	1%	
Storage Length (ft)		150	175		0	350
Storage Lanes		1	1		2	2
Taper Length (ft)			75		75	
Lane Util. Factor	0.95	1.00	1.00	0.95	0.97	1.00
Frt		0.850				0.850
Flt Protected			0.950		0.950	
Satd. Flow (prot)	3274	1683	1557	3369	3268	1626
Flt Permitted			0.072		0.950	
Satd. Flow (perm)	3274	1683	118	3369	3268	1626
Right Turn on Red		Yes				Yes
Satd. Flow (RTOR)		328				8
Link Speed (mph)	45			45	40	
Link Distance (ft)	550			523	600	
Travel Time (s)	8.3			7.9	10.2	
Peak Hour Factor	0.96	0.96	0.96	0.96	0.96	0.96
Heavy Vehicles (%)	2%	1%	2%	1%	1%	3%
Adj. Flow (vph)	1330	683	418	1221	516	417
Shared Lane Traffic (%)						
Lane Group Flow (vph)	1330	683	418	1221	516	417
Number of Detectors	1	1	1	1	1	1
Detector Template						
Leading Detector (ft)	5	5	35	5	35	35
Trailing Detector (ft)	0	0	-5	0	-5	-5
Detector 1 Position(ft)	0	0	-5	0	-5	-5
Detector 1 Size(ft)	5	5	40	5	40	40
Detector 1 Type	CI+Ex	CI+Ex	CI+Ex	CI+Ex	CI+Ex	CI+Ex
Detector 1 Channel						
Detector 1 Extend (s)	0.0	0.0	0.0	0.0	0.0	0.0
Detector 1 Queue (s)	0.0	0.0	0.0	0.0	0.0	0.0
Detector 1 Delay (s)	0.0	0.0	0.0	0.0	0.0	0.0
Turn Type	NA	Perm	pm+pt	NA	Prot	pm+ov
Protected Phases	2		1	6	8	1
Permitted Phases		2	6			8
Minimum Initial (s)	20.0	20.0	3.0	20.0	7.0	3.0
Minimum Split (s)	27.0	27.0	10.0	27.0	14.0	10.0
Total Split (s)	51.0	51.0	43.0	94.0	26.0	43.0
Total Split (%)	42.5%	42.5%	35.8%	78.3%	21.7%	35.8%
Maximum Green (s)	44.0	44.0	36.0	87.0	19.0	36.0
Yellow Time (s)	5.0	5.0	5.0	5.0	4.0	5.0
All-Red Time (s)	2.0	2.0	2.0	2.0	3.0	2.0
Total Lost Time (s)	6.0	6.0	6.0	6.0	6.0	6.0
Lead/Lag	Lag	Lag	Lead			Lead
Lead-Lag Optimize?						
Vehicle Extension (s)	3.0	3.0	3.0	3.0	3.0	3.0

BT Dreshertown, LP
 3: Dreshertown Road & Welsh Road

2023 With PM Peak



Lane Group	EBT	EBR	WBL	WBT	NBL	NBR
Recall Mode	C-Max	C-Max	None	C-Max	None	None
Act Effct Green (s)	49.8	49.8	88.0	88.0	20.0	58.2
Actuated g/C Ratio	0.42	0.42	0.73	0.73	0.17	0.48
v/c Ratio	0.98	0.77	0.89	0.49	0.95	0.53
Control Delay	41.4	13.2	56.4	6.1	72.1	31.0
Queue Delay	12.8	0.8	0.1	0.0	43.5	0.0
Total Delay	54.1	13.9	56.4	6.1	115.6	31.0
LOS	D	B	E	A	F	C
Approach Delay	40.5			18.9	77.8	
Approach LOS	D			B	E	

Intersection Summary

Area Type: Other
 Cycle Length: 120
 Actuated Cycle Length: 120
 Offset: 29 (24%), Referenced to phase 2:EBT and 6:WBTL, Start of 1st Green
 Control Type: Actuated-Coordinated
 Maximum v/c Ratio: 0.98
 Intersection Signal Delay: 40.4
 Intersection Capacity Utilization 90.6%
 Analysis Period (min) 15
 Intersection LOS: D
 ICU Level of Service E

Splits and Phases: 3: Dreshertown Road & Welsh Road

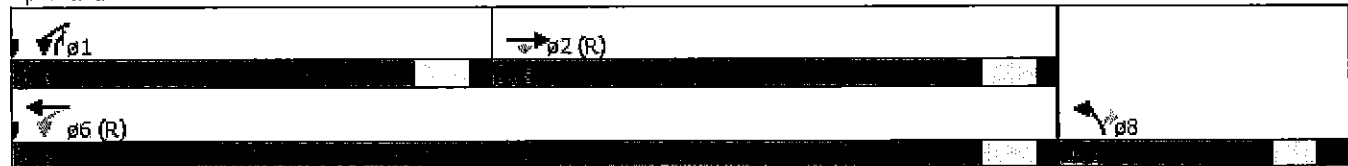



Movement	EBT	EBR	WBL	WBT	NBL	NBR
Lane Configurations	↑↑	↑	↓	↑↑	↓↓	↑
Volume (veh/h)	1277	656	401	1172	495	400
Number	2	12	1	6	3	18
Initial Q (Qb), veh	0	0	0	0	0	0
Ped-Bike Adj(A_pbT)		1.00	1.00		1.00	1.00
Parking Bus, Adj	1.00	1.00	1.00	1.00	1.00	1.00
Adj Sat Flow, veh/h/ln	1782	1872	1756	1773	1773	1808
Adj Flow Rate, veh/h	1330	657	418	1221	516	371
Adj No. of Lanes	2	1	1	2	2	1
Peak Hour Factor	0.96	0.96	0.96	0.96	0.96	0.96
Percent Heavy Veh, %	2	1	2	1	1	3
Cap, veh/h	1575	740	451	2471	546	591
Arrive On Green	0.47	0.47	0.44	1.00	0.17	0.17
Sat Flow, veh/h	3476	1591	1672	3458	3276	1537
Grp Volume(v), veh/h	1330	657	418	1221	516	371
Grp Sat Flow(s),veh/h/ln	1693	1591	1672	1685	1638	1537
Q Serve(g_s), s	41.5	45.1	21.5	0.0	18.7	20.0
Cycle Q Clear(g_c), s	41.5	45.1	21.5	0.0	18.7	20.0
Prop In Lane		1.00	1.00		1.00	1.00
Lane Grp Cap(c), veh/h	1575	740	451	2471	546	591
V/C Ratio(X)	0.84	0.89	0.93	0.49	0.94	0.63
Avail Cap(c_a), veh/h	1575	740	601	2471	546	591
HCM Platoon Ratio	1.00	1.00	2.00	2.00	1.00	1.00
Upstream Filter(I)	0.57	0.57	1.00	1.00	0.77	0.77
Uniform Delay (d), s/veh	28.3	29.2	22.6	0.0	49.5	29.9
Incr Delay (d2), s/veh	3.4	9.3	17.4	0.7	21.4	1.6
Initial Q Delay(d3),s/veh	0.0	0.0	0.0	0.0	0.0	0.0
%ile BackOfQ(95%),veh/ln	25.7	27.4	21.0	0.4	14.6	14.9
LnGrp Delay(d),s/veh	31.6	38.5	40.0	0.7	70.8	31.6
LnGrp LOS	C	D	D	A	E	C
Approach Vol, veh/h	1987			1639	887	
Approach Delay, s/veh	33.9			10.7	54.4	
Approach LOS	C			B	D	

Phaser	1	2	3	4	5	6	7	8
Assigned Phs	1	2				6		8
Phs Duration (G+Y+Rc), s	32.2	61.8				94.0		26.0
Change Period (Y+Rc), s	7.0	7.0				7.0		7.0
Max Green Setting (Gmax), s	36.0	44.0				87.0		19.0
Max Q Clear Time (g_c+1), s	24.0	47.1				2.5		22.5
Green Ext Time (p_c), s	1.2	0.0				21.4		0.0

Intersection Summary	
HCM 2010 Ctrl Delay	29.5
HCM 2010 LOS	C

BT Dreshertown, LP
4: Dryden Road & Welsh Road

2023 With PM Peak



Lane Group	EBL	EBT	EBR	WBL	WBT	WBR	NBL	NBT	NBR	SBL	SBT	SBR
Lane Configurations	↖	↕	↗	↖	↕		↖	↗		↖	↗	
Volume (vph)	0	1618	67	245	1353	0	213	8	162	3	0	1
Ideal Flow (vphpl)	1800	1800	1800	1800	1800	1800	1800	1800	1800	1800	1800	1800
Lane Width (ft)	10	12	14	10	12	12	11	15	15	12	14	14
Grade (%)		-1%			-1%			-1%			0%	
Storage Length (ft)	150		225	175		0	110		0	150		0
Storage Lanes	1		1	1		0	1		0	1		0
Taper Length (ft)	75			75			75			75		
Lane Util. Factor	1.00	0.95	1.00	1.00	0.95	0.95	1.00	1.00	1.00	1.00	1.00	1.00
Frt			0.850					0.857			0.850	
Fit Protected				0.950			0.950			0.950		
Satd. Flow (prot)	1688	3403	1640	1604	3370	0	1661	1705	0	1710	1632	0
Fit Permitted				0.114			0.757			0.415		
Satd. Flow (perm)	1688	3403	1640	192	3370	0	1324	1705	0	747	1632	0
Right Turn on Red			Yes			Yes			Yes			Yes
Satd. Flow (RTOR)			69					61			100	
Link Speed (mph)		45			45			25			25	
Link Distance (ft)		517			1416			754			960	
Travel Time (s)		7.8			21.5			20.6			26.2	
Peak Hour Factor	0.97	0.97	0.97	0.97	0.97	0.97	0.97	0.97	0.97	0.97	0.97	0.97
Heavy Vehicles (%)	0%	1%	0%	0%	2%	0%	0%	0%	0%	0%	0%	0%
Adj. Flow (vph)	0	1668	69	253	1395	0	220	8	167	3	0	1
Shared Lane Traffic (%)												
Lane Group Flow (vph)	0	1668	69	253	1395	0	220	175	0	3	1	0
Number of Detectors	1	1	1	1	1		1	1		1	1	
Detector Template												
Leading Detector (ft)	5	5	5	5	5		35	35		35	35	
Trailing Detector (ft)	0	0	0	0	0		-5	-5		-5	-5	
Detector 1 Position(ft)	0	0	0	0	0		-5	-5		-5	-5	
Detector 1 Size(ft)	5	5	5	5	5		40	40		40	40	
Detector 1 Type	CI+Ex	CI+Ex	CI+Ex	CI+Ex	CI+Ex		CI+Ex	CI+Ex		CI+Ex	CI+Ex	
Detector 1 Channel												
Detector 1 Extend (s)	0.0	0.0	0.0	0.0	0.0		0.0	0.0		0.0	0.0	
Detector 1 Queue (s)	0.0	0.0	0.0	0.0	0.0		0.0	0.0		0.0	0.0	
Detector 1 Delay (s)	0.0	0.0	0.0	0.0	0.0		0.0	0.0		0.0	0.0	
Turn Type	Perm	NA	Perm	Perm	NA		Perm	NA		Perm	NA	
Protected Phases		2			6			8			4	
Permitted Phases	2		2	6			8			4		
Minimum Initial (s)	21.0	21.0	21.0	21.0	21.0		5.0	5.0		5.0	5.0	
Minimum Split (s)	27.0	27.0	27.0	27.0	27.0		11.0	11.0		11.0	11.0	
Total Split (s)	98.0	98.0	98.0	98.0	98.0		22.0	22.0		22.0	22.0	
Total Split (%)	81.7%	81.7%	81.7%	81.7%	81.7%		18.3%	18.3%		18.3%	18.3%	
Maximum Green (s)	92.0	92.0	92.0	92.0	92.0		16.0	16.0		16.0	16.0	
Yellow Time (s)	4.0	4.0	4.0	4.0	4.0		3.0	3.0		3.0	3.0	
All-Red Time (s)	2.0	2.0	2.0	2.0	2.0		3.0	3.0		3.0	3.0	
Total Lost Time (s)	5.0	5.0	5.0	5.0	5.0		5.0	5.0		5.0	5.0	
Lead/Lag												
Lead-Lag Optimize?												
Vehicle Extension (s)	3.0	3.0	3.0	3.0	3.0		3.0	3.0		3.0	3.0	

BT Dreshertown, LP
4: Dryden Road & Welsh Road

2023 With PM Peak



Lane Group	EBL	EBT	EBR	WBL	WBT	WBR	NBL	NBT	NBR	SBL	SBT	SBR
Recall Mode	C-Max	C-Max	C-Max	C-Max	C-Max		None	None		None	None	
Act Effct Green (s)		93.0	93.0	93.0	93.0		17.0	17.0		17.0	17.0	
Actuated g/C Ratio		0.78	0.78	0.78	0.78		0.14	0.14		0.14	0.14	
v/c Ratio		0.63	0.05	1.71	0.53		1.18	0.60		0.03	0.00	
Control Delay		3.2	0.3	365.4	6.1		166.4	40.4		45.3	0.0	
Queue Delay		0.0	0.0	0.0	0.0		0.0	0.0		0.0	0.0	
Total Delay		3.2	0.3	365.4	6.1		166.4	40.4		45.3	0.0	
LOS		A	A	F	A		F	D		D	A	
Approach Delay		3.1			61.2			110.6			34.0	
Approach LOS		A			E			F			C	

Intersection Summary

Area Type: Other
 Cycle Length: 120
 Actuated Cycle Length: 120
 Offset: 59 (49%), Referenced to phase 2:EBTL and 6:WBTL, Start of 1st Green
 Control Type: Actuated-Coordinated
 Maximum v/c Ratio: 1.71
 Intersection Signal Delay: 39.7
 Intersection Capacity Utilization 96.3%
 Analysis Period (min) 15
 Intersection LOS: D
 ICU Level of Service F

Splits and Phases: 4: Dryden Road & Welsh Road

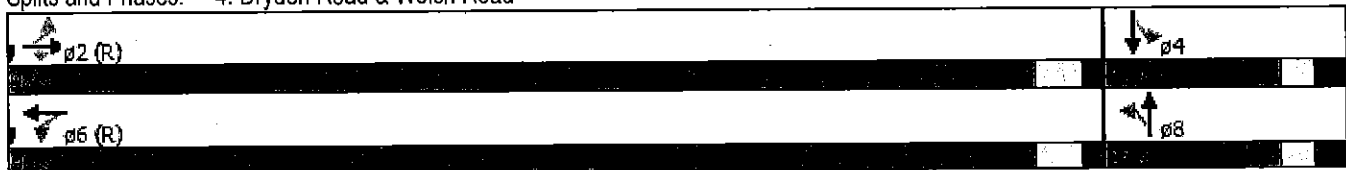

Movement	EBL	EBI	EBR	WBL	WBI	WBR	NBL	NET	NBR	SBL	SBT	SBR
Lane Configurations												
Volume (veh/h)	0	1618	67	245	1353	0	213	8	162	3	0	1
Number	5	2	12	1	6	16	3	8	18	7	4	14
Initial Q (Qb), veh	0	0	0	0	0	0	0	0	0	0	0	0
Ped-Bike Adj(A_pbT)	1.00		1.00	1.00		1.00	1.00		1.00	1.00		1.00
Parking Bus, Adj	1.00	1.00	1.00	1.00	1.00	1.00	1.00	1.00	1.00	1.00	1.00	1.00
Adj Sat Flow, veh/h/ln	1809	1791	1881	1809	1774	1809	1809	1881	1881	1800	1872	1872
Adj Flow Rate, veh/h	0	1668	67	253	1395	0	220	8	167	3	0	1
Adj No. of Lanes	1	2	1	1	2	0	1	1	0	1	1	0
Peak Hour Factor	0.97	0.97	0.97	0.97	0.97	0.97	0.97	0.97	0.97	0.97	0.97	0.97
Percent Heavy Veh, %	0	1	0	0	2	2	0	0	0	0	0	0
Cap, veh/h	60	2637	1239	281	2612	0	265	10	218	110	0	225
Arrive On Green	0.00	1.00	1.00	0.77	0.77	0.00	0.14	0.14	0.13	0.14	0.00	0.13
Sat Flow, veh/h	395	3403	1599	285	3458	0	1446	74	1537	1229	0	1591
Grp Volume(v), veh/h	0	1668	67	253	1395	0	220	0	175	3	0	1
Grp Sat Flow(s), veh/h/ln	395	1702	1599	285	1685	0	1446	0	1610	1229	0	1591
Q Serve(g_s), s	0.0	0.0	0.0	93.0	19.1	0.0	17.0	0.0	12.6	0.3	0.0	0.1
Cycle Q Clear(g_c), s	0.0	0.0	0.0	93.0	19.1	0.0	17.0	0.0	12.6	12.4	0.0	0.1
Prop In Lane	1.00		1.00	1.00		0.00	1.00		0.95	1.00		1.00
Lane Grp Cap(c), veh/h	60	2637	1239	281	2612	0	265	0	228	110	0	225
V/C Ratio(X)	0.00	0.63	0.05	0.90	0.53	0.00	0.83	0.00	0.77	0.03	0.00	0.00
Avail Cap(c_a), veh/h	60	2637	1239	281	2612	0	265	0	228	110	0	225
HCM Platoon Ratio	2.00	2.00	2.00	1.00	1.00	1.00	1.00	1.00	1.00	1.00	1.00	1.00
Upstream Filter(I)	0.00	1.00	1.00	1.00	1.00	0.00	1.00	0.00	1.00	1.00	0.00	1.00
Uniform Delay (d), s/veh	0.0	0.0	0.0	19.5	5.2	0.0	52.1	0.0	50.1	55.3	0.0	44.7
Incr Delay (d2), s/veh	0.0	1.2	0.1	33.5	0.8	0.0	19.5	0.0	14.5	0.1	0.0	0.0
Initial Q Delay(d3),s/veh	0.0	0.0	0.0	0.0	0.0	0.0	0.0	0.0	0.0	0.0	0.0	0.0
%ile BackOfQ(95%),veh/ln	0.0	0.8	0.1	16.4	13.9	0.0	13.5	0.0	10.7	0.2	0.0	0.1
LnGrp Delay(d),s/veh	0.0	1.2	0.1	52.9	6.0	0.0	71.6	0.0	64.6	55.4	0.0	44.7
LnGrp LOS		A	A	D	A		E		E	E		D
Approach Vol, veh/h		1735			1648			395				4
Approach Delay, s/veh		1.1			13.2			68.5				52.7
Approach LOS		A			B			E				D
Timer	1	2	3	4	5	6	7	8				
Assigned Phs		2		4		6		8				
Phs Duration (G+Y+Rc), s		98.0		22.0		98.0		22.0				
Change Period (Y+Rc), s		6.0		6.0		6.0		6.0				
Max Green Setting (Gmax), s		92.0		16.0		92.0		16.0				
Max Q Clear Time (g_c+1), s		2.5		14.9		95.5		19.5				
Green Ext Time (p_c), s		44.3		0.2		0.0		0.0				
Intersection Summary												
HCM 2010 Ctrl Delay				13.5								
HCM 2010 LOS				B								

BT Dreshertown, LP
5: Dreshertown Road & Dryden Road

2023 With PM Peak

Lane Group	WBL	WBR	NBT	NBR	SBL	SBT
Lane Configurations	↙	↗	↑	↖	↘	↑
Volume (vph)	172	93	803	170	89	969
Ideal Flow (vphpl)	1800	1800	1800	1800	1800	1800
Lane Width (ft)	12	14	12	14	12	12
Grade (%)	0%		1%			0%
Storage Length (ft)	0	200		225	175	
Storage Lanes	1	1		1	1	
Taper Length (ft)	75			75		
Lane Util. Factor	1.00	1.00	1.00	1.00	1.00	1.00
Fr		0.850		0.850		
Fit Protected	0.950				0.950	
Satd. Flow (prot)	1676	1600	1756	1592	1676	1765
Fit Permitted	0.950				0.269	
Satd. Flow (perm)	1676	1600	1756	1592	475	1765
Right Turn on Red		Yes		Yes		
Satd. Flow (RTOR)		97		147		
Link Speed (mph)	25		40			40
Link Distance (ft)	593		817			600
Travel Time (s)	16.2		13.9			10.2
Peak Hour Factor	0.96	0.96	0.96	0.96	0.96	0.96
Adj. Flow (vph)	179	97	836	177	93	1009
Shared Lane Traffic (%)						
Lane Group Flow (vph)	179	97	836	177	93	1009
Number of Detectors	1	1	1	1	1	1
Detector Template	Left	Right	Thru	Right	Left	Thru
Leading Detector (ft)	35	35	5	5	35	5
Trailing Detector (ft)	-5	-5	0	0	-5	0
Detector 1 Position(ft)	-5	-5	0	0	-5	0
Detector 1 Size(ft)	40	40	5	5	40	5
Detector 1 Type	CI+Ex	CI+Ex	CI+Ex	CI+Ex	CI+Ex	CI+Ex
Detector 1 Channel						
Detector 1 Extend (s)	0.0	0.0	0.0	0.0	0.0	0.0
Detector 1 Queue (s)	0.0	0.0	0.0	0.0	0.0	0.0
Detector 1 Delay (s)	0.0	0.0	0.0	0.0	0.0	0.0
Turn Type	Prot	Perm	NA	Perm	Perm	NA
Protected Phases	8		2			6
Permitted Phases		8		2	6	
Minimum Initial (s)	15.0	15.0	20.0	20.0	20.0	20.0
Minimum Split (s)	21.0	21.0	26.0	26.0	26.0	26.0
Total Split (s)	47.0	47.0	73.0	73.0	73.0	73.0
Total Split (%)	39.2%	39.2%	60.8%	60.8%	60.8%	60.8%
Maximum Green (s)	41.0	41.0	67.0	67.0	67.0	67.0
Yellow Time (s)	4.0	4.0	4.0	4.0	4.0	4.0
All-Red Time (s)	2.0	2.0	2.0	2.0	2.0	2.0
Total Lost Time (s)	5.0	5.0	5.0	5.0	5.0	5.0
Lead/Lag						
Lead-Lag Optimize?						
Vehicle Extension (s)	3.0	3.0	3.0	3.0	3.0	3.0
Recall Mode	None	None	C-Max	C-Max	C-Max	C-Max

BT Dreshertown, LP
 5: Dreshertown Road & Dryden Road

2023 With PM Peak



Lane Group	WBL	WBR	NBT	NBR	SBL	SBT
Act Effect Green (s)	20.0	20.0	90.0	90.0	90.0	90.0
Actuated g/C Ratio	0.17	0.17	0.75	0.75	0.75	0.75
v/c Ratio	0.64	0.28	0.64	0.14	0.26	0.76
Control Delay	56.9	9.8	10.6	1.5	2.5	5.5
Queue Delay	0.0	0.0	0.0	0.0	0.0	0.5
Total Delay	56.9	9.8	10.6	1.5	2.5	6.0
LOS	E	A	B	A	A	A
Approach Delay	40.4		9.0			5.7
Approach LOS	D		A			A

Intersection Summary

Area Type: Other
 Cycle Length: 120
 Actuated Cycle Length: 120
 Offset: 60 (50%), Referenced to phase 2:NBT and 6:SBTL, Start of 1st Green
 Control Type: Actuated-Coordinated
 Maximum v/c Ratio: 0.76
 Intersection Signal Delay: 11.1
 Intersection Capacity Utilization 86.3%
 Analysis Period (min) 15

Intersection LOS: B
 ICU Level of Service E

Splits and Phases: 5: Dreshertown Road & Dryden Road

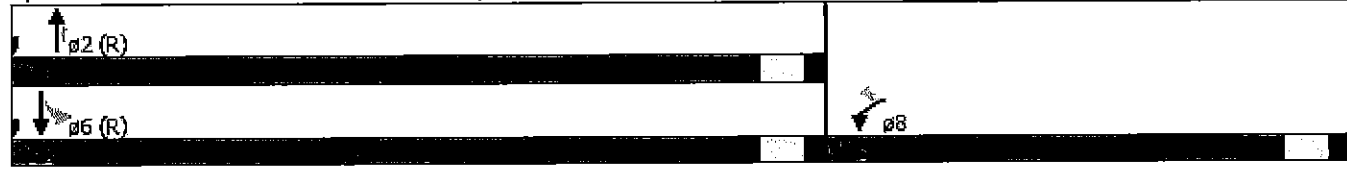



Movement	WBL	WBR	NBT	NBP	SBL	SBT
Lane Configurations	↖	↗	↑	↑	↘	↙
Volume (veh/h)	172	93	803	170	89	969
Number	3	18	2	12	1	6
Initial Q (Qb), veh	0	0	0	0	0	0
Ped-Bike Adj(A_pbT)	1.00	1.00		1.00	1.00	
Parking Bus, Adj	1.00	1.00	1.00	1.00	1.00	1.00
Adj Sat Flow, veh/h/ln	1765	1835	1756	1826	1765	1765
Adj Flow Rate, veh/h	179	97	836	177	93	1009
Adj No. of Lanes	1	1	1	1	1	1
Peak Hour Factor	0.96	0.96	0.96	0.96	0.96	0.96
Percent Heavy Veh, %	2	2	2	2	2	2
Cap, veh/h	235	218	1364	1205	378	1371
Arrive On Green	0.14	0.14	0.78	0.78	0.78	0.78
Sat Flow, veh/h	1681	1560	1756	1552	554	1765
Grp Volume(v), veh/h	179	97	836	177	93	1009
Grp Sat Flow(s),veh/h/ln	1681	1560	1756	1552	554	1765
Q Serve(g_s), s	12.3	6.8	24.4	3.5	10.3	35.8
Cycle Q Clear(g_c), s	12.3	6.8	24.4	3.5	34.7	35.8
Prop In Lane	1.00	1.00		1.00	1.00	
Lane Grp Cap(c), veh/h	235	218	1364	1205	378	1371
V/C Ratio(X)	0.76	0.44	0.61	0.15	0.25	0.74
Avail Cap(c_a), veh/h	588	546	1364	1205	378	1371
HCM Platoon Ratio	1.00	1.00	1.00	1.00	1.00	1.00
Upstream Filter(I)	1.00	1.00	1.00	1.00	0.48	0.48
Uniform Delay (d), s/veh	49.7	47.3	5.7	3.4	13.1	7.0
Incr Delay (d2), s/veh	5.0	1.4	2.1	0.3	0.7	1.7
Initial Q Delay(d3),s/veh	0.0	0.0	0.0	0.0	0.0	0.0
%ile BackOfQ(95%),veh/ln	10.1	5.4	18.2	2.8	3.0	22.5
LnGrp Delay(d),s/veh	54.7	48.7	7.8	3.6	13.9	8.7
LnGrp LOS	D	D	A	A	B	A
Approach Vol, veh/h	276		1013			1102
Approach Delay, s/veh	52.6		7.1			9.2
Approach LOS	D		A			A

Timer	1	2	3	4	5	6	7	8
Assigned Phs		2				6		8
Phs Duration (G+Y+Rc), s		98.2				98.2		21.8
Change Period (Y+Rc), s		6.0				6.0		6.0
Max Green Setting (Gmax), s		67.0				67.0		41.0
Max Q Clear Time (g_c+1), s		26.9				38.3		14.8
Green Ext Time (p_c), s		9.8				9.2		1.0

Intersection Summary	
HCM 2010 Ctrl Delay	13.3
HCM 2010 LOS	B

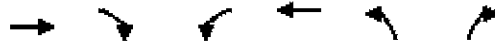

Lane Group	EBT	FBR	WBL	WET	NBL	NBR
Lane Configurations	↑↑	↑		↑↑		↑
Volume (vph)	1617	98	0	1572	0	68
Ideal Flow (vphpl)	1800	1800	1800	1800	1800	1800
Lane Width (ft)	12	14	12	12	12	12
Grade (%)	-1%			1%	0%	
Storage Length (ft)		225	0		0	0
Storage Lanes		1	0		0	1
Taper Length (ft)			75		75	
Lane Util. Factor	0.95	1.00	1.00	0.95	1.00	1.00
Flt		0.850				0.865
Flt Protected						
Satd. Flow (prot)	3403	1608	0	3336	0	1526
Flt Permitted						
Satd. Flow (perm)	3403	1608	0	3336	0	1526
Link Speed (mph)	45			45	25	
Link Distance (ft)	523			517	321	
Travel Time (s)	7.9			7.8	8.8	
Peak Hour Factor	0.90	0.90	0.90	0.90	0.90	0.90
Heavy Vehicles (%)	1%	2%	0%	2%	0%	2%
Adj. Flow (vph)	1797	109	0	1747	0	76
Shared Lane Traffic (%)						
Lane Group Flow (vph)	1797	109	0	1747	0	76
Sign Control	Free			Free	Stop	

Intersection Summary

Area Type: Other
Control Type: Unsignalized

Intersection

Int Delay, s/veh 0.4

Movement	EBT	EBR	WBL	WBT	NBL	NBR
Vol, veh/h	1617	98	0	1572	0	68
Conflicting Peds, #/hr	0	0	0	0	0	0
Sign Control	Free	Free	Free	Free	Stop	Stop
RT Channelized	-	None	-	None	-	None
Storage Length	-	225	-	-	-	0
Veh in Median Storage, #	0	-	-	0	0	-
Grade, %	-1	-	-	1	0	-
Peak Hour Factor	90	90	90	90	90	90
Heavy Vehicles, %	1	2	0	2	0	2
Mvmt Flow	1797	109	0	1747	0	76

Major/Minor	Major1	Major2	Minor1	Minor2
Conflicting Flow All	0	0	1797	0
Stage 1	-	-	-	-
Stage 2	-	-	-	-
Critical Hdwy	-	-	4.1	-
Critical Hdwy Stg 1	-	-	-	-
Critical Hdwy Stg 2	-	-	-	-
Follow-up Hdwy	-	-	2.2	-
Pot Cap-1 Maneuver	-	-	348	-
Stage 1	-	-	-	-
Stage 2	-	-	-	-
Platoon blocked, %	-	-	-	-
Mov Cap-1 Maneuver	-	-	348	-
Mov Cap-2 Maneuver	-	-	-	-
Stage 1	-	-	-	-
Stage 2	-	-	-	-

Approach	EB	WB	NS
HCM Control Delay, s	0	0	21.8
HCM LOS			C

Minor Lane/Major Mvmt	NBLn1	EBT	EBR	WBL	WBT
Capacity (veh/h)	289	-	-	348	-
HCM Lane W/C Ratio	0.261	-	-	-	-
HCM Control Delay (s)	21.8	-	-	0	-
HCM Lane LOS	C	-	-	A	-
HCM 95th %tile Q(veh)	1	-	-	0	-

BT Dreshertown, LP
 1: Jarrettown Road/Village Road & Welsh Road

2023 With SAT Peak



Lane Group	EBL	EBT	EBR	WBL	WBT	WBR	NEL	NBT	NBR	SBL	SBT	SBR
Lane Configurations	↙	↕		↙	↕			↕	↙		↕	
Volume (vph)	11	739	20	164	688	8	7	2	220	13	2	7
Ideal Flow (vphpl)	1800	1800	1800	1800	1800	1800	1800	1800	1800	1800	1800	1800
Lane Width (ft)	12	12	12	11	14	14	12	12	14	15	15	15
Grade (%)		-6%			1%			-1%			1%	
Storage Length (ft)	150		0	100		0	0		175	0		0
Storage Lanes	1		0	1		0	0		1	0		0
Taper Length (ft)	75			75			75			75		
Lane Util. Factor	1.00	0.95	0.95	1.00	1.00	1.00	1.00	1.00	1.00	1.00	1.00	1.00
Frt		0.996			0.998				0.850		0.955	
Flt Protected	0.950			0.950				0.962			0.972	
Satd. Flow (prot)	1761	3452	0	1612	1907	0	0	1740	1640	0	1829	0
Flt Permitted	0.375			0.294				0.857			0.815	
Satd. Flow (perm)	695	3452	0	499	1907	0	0	1550	1640	0	1533	0
Right Turn on Red			Yes			Yes			Yes			Yes
Satd. Flow (RTOR)		4			2				168		8	
Link Speed (mph)		45			45			35			35	
Link Distance (ft)		1263			605			421			431	
Travel Time (s)		19.1			9.2			8.2			8.4	
Peak Hour Factor	0.91	0.91	0.91	0.91	0.91	0.91	0.91	0.91	0.91	0.91	0.91	0.91
Heavy Vehicles (%)	0%	1%	25%	2%	0%	0%	0%	0%	0%	0%	0%	0%
Adj. Flow (vph)	12	812	22	180	756	9	8	2	242	14	2	8
Shared Lane Traffic (%)												
Lane Group Flow (vph)	12	834	0	180	765	0	0	10	242	0	24	0
Number of Detectors	1	2		1	2		1	1	1	1	1	
Detector Template	Left			Left			Left	Thru	Right	Left	Thru	
Leading Detector (ft)	5	330		35	330		20	35	35	20	35	
Trailing Detector (ft)	0	0		-5	0		0	-5	-5	0	-5	
Detector 1 Position(ft)	0	0		-5	0		0	-5	-5	0	-5	
Detector 1 Size(ft)	5	6		40	6		20	40	40	20	40	
Detector 1 Type	CI+Ex	CI+Ex		CI+Ex	CI+Ex		CI+Ex	CI+Ex	CI+Ex	CI+Ex	CI+Ex	
Detector 1 Channel												
Detector 1 Extend (s)	0.0	0.0		0.0	0.0		0.0	0.0	0.0	0.0	0.0	
Detector 1 Queue (s)	0.0	0.0		0.0	0.0		0.0	0.0	0.0	0.0	0.0	
Detector 1 Delay (s)	0.0	0.0		0.0	0.0		0.0	0.0	0.0	0.0	0.0	
Detector 2 Position(ft)		324			324							
Detector 2 Size(ft)		6			6							
Detector 2 Type		CI+Ex			CI+Ex							
Detector 2 Channel												
Detector 2 Extend (s)		0.0			0.0							
Turn Type	Perm	NA		pm+pt	NA		Perm	NA	pm+ov	Perm	NA	
Protected Phases		2		1	6			8	1		4	
Permitted Phases	2			6			8		8	4		
Detector Phase	2	2		1	6		8	8	1	4	4	
Switch Phase												
Minimum Initial (s)	15.0	15.0		3.0	15.0		7.0	7.0	3.0	7.0	7.0	
Minimum Split (s)	22.0	22.0		10.0	22.0		13.0	13.0	10.0	13.0	13.0	
Total Split (s)	63.0	63.0		19.0	82.0		18.0	18.0	19.0	18.0	18.0	
Total Split (%)	63.0%	63.0%		19.0%	82.0%		18.0%	18.0%	19.0%	18.0%	18.0%	

BT Dreshertown, LP
 1: Jarrettown Road/Village Road & Welsh Road

2023 With SAT Peak



Lane Group	EBL	EBT	EBR	WBL	WBT	WBF	NBL	NBT	NBR	SBL	SBT	SBF
Yellow Time (s)	5.0	5.0		5.0	5.0		4.0	4.0	5.0	4.0	4.0	
All-Red Time (s)	2.0	2.0		2.0	2.0		2.0	2.0	2.0	2.0	2.0	
Lost Time Adjust (s)	-1.0	-1.0		-1.0	-1.0			-1.0	-1.0			-1.0
Total Lost Time (s)	6.0	6.0		6.0	6.0			5.0	6.0			5.0
Lead/Lag	Lag	Lag		Lead					Lead			
Lead-Lag Optimize?												
Recall Mode	C-Max	C-Max		None	C-Max		None	None	None	None	None	None

Intersection Summary

Area Type: Other
 Cycle Length: 100
 Actuated Cycle Length: 100
 Offset: 26 (26%), Referenced to phase 2:EBTL and 6:WBTL, Start of 1st Green
 Natural Cycle: 45
 Control Type: Actuated-Coordinated

Splits and Phases: 1: Jarrettown Road/Village Road & Welsh Road



BT Dreshertown, LP
 1: Jarrettown Road/Village Road & Welsh Road

2023 With SAT Peak



Movement	EBL	EBT	EBR	WBL	WBT	WBR	NBL	NBT	NBR	SBL	SBT	SBR
Lane Configurations	↖	↕		↖	↕			↕	↗		↕	
Volume (veh/h)	11	739	20	164	688	8	7	2	220	13	2	7
Number	5	2	12	1	6	16	3	8	18	7	4	14
Initial Q (Qb), veh	0	0	0	0	0	0	0	0	0	0	0	0
Ped-Bike Adj(A_pbT)	1.00		1.00	1.00		1.00	1.00		1.00	1.00		1.00
Parking Bus, Adj	1.00	1.00	1.00	1.00	1.00	1.00	1.00	1.00	1.00	1.00	1.00	1.00
Adj Sat Flow, veh/h/ln	1854	1824	1854	1756	1863	1863	1809	1809	1881	1863	1863	1863
Adj Flow Rate, veh/h	12	812	21	180	756	9	8	2	144	14	2	3
Adj No. of Lanes	1	2	0	1	1	0	0	1	1	0	1	0
Peak Hour Factor	0.91	0.91	0.91	0.91	0.91	0.91	0.91	0.91	0.91	0.91	0.91	0.91
Percent Heavy Veh, %	0	1	1	2	0	0	0	0	0	0	0	0
Cap, veh/h	529	2229	58	537	1422	17	198	43	295	173	28	26
Arrive On Green	0.65	0.65	0.64	0.07	0.77	0.76	0.11	0.12	0.12	0.11	0.12	0.11
Sat Flow, veh/h	735	3452	89	1672	1837	22	1154	374	1599	953	239	224
Grp Volume(v), veh/h	12	408	425	180	0	765	10	0	144	19	0	0
Grp Sat Flow(s), veh/h/ln	735	1733	1808	1672	0	1859	1528	0	1599	1416	0	0
Q Serve(g_s), s	0.6	10.9	10.9	3.1	0.0	15.8	0.0	0.0	8.1	0.3	0.0	0.0
Cycle Q Clear(g_c), s	3.0	10.9	10.9	3.1	0.0	15.8	0.5	0.0	8.1	1.0	0.0	0.0
Prop In Lane	1.00		0.05	1.00		0.01	0.80		1.00	0.74		0.16
Lane Grp Cap(c), veh/h	529	1119	1168	537	0	1439	226	0	295	212	0	0
V/C Ratio(X)	0.02	0.36	0.36	0.33	0.00	0.53	0.04	0.00	0.49	0.09	0.00	0.00
Avail Cap(c_a), veh/h	529	1119	1168	640	0	1439	248	0	318	232	0	0
HCM Platoon Ratio	1.00	1.00	1.00	1.00	1.00	1.00	1.00	1.00	1.00	1.00	1.00	1.00
Upstream Filter(I)	1.00	1.00	1.00	1.00	0.00	1.00	1.00	0.00	1.00	1.00	0.00	0.00
Uniform Delay (d), s/veh	7.3	8.2	8.2	5.0	0.0	4.3	39.7	0.0	36.6	39.9	0.0	0.0
Incr Delay (d2), s/veh	0.1	0.9	0.9	0.4	0.0	1.4	0.1	0.0	1.3	0.2	0.0	0.0
Initial Q Delay(d3),s/veh	0.0	0.0	0.0	0.0	0.0	0.0	0.0	0.0	0.0	0.0	0.0	0.0
%ile BackOfQ(95%),veh/ln	0.2	9.3	9.7	2.6	0.0	13.2	0.5	0.0	6.6	0.9	0.0	0.0
LnGrp Delay(d),s/veh	7.4	9.1	9.1	5.4	0.0	5.7	39.8	0.0	37.8	40.1	0.0	0.0
LnGrp LOS	A	A	A	A		A	D		D	D		
Approach Vol, veh/h		845			945			154			19	
Approach Delay, s/veh		9.1			5.7			37.9			40.1	
Approach LOS		A			A			D			D	

Time	1	2	3	4	5	6	7	8
Assigned Phs	1	2		4		6		8
Phs Duration (G+Y+Rc), s	12.9	70.6		16.6		83.4		16.6
Change Period (Y+Rc), s	7.0	7.0		6.0		7.0		6.0
Max Green Setting (Gmax), s	12.0	56.0		12.0		75.0		12.0
Max Q Clear Time (g_c+I1), s	5.6	13.4		3.0		17.8		10.6
Green Ext Time (p_c), s	0.3	35.3		0.4		44.9		0.1

Intersection Summary	
HCM 2010 Ctrl Delay	10.0
HCM 2010 LOS	B

BT Dreshertown, LP
2: Welsh Road & Dresher Road

2023 With SAT Peak



Lane Group	EBL	EBT	WBT	WBR	SBL	SBR
Lane Configurations	↘	↑↑	↑↑	↗	↘↗	↗
Volume (vph)	154	850	751	500	473	148
Ideal Flow (vphpl)	1800	1800	1800	1800	1800	1800
Lane Width (ft)	10	11	11	11	12	13
Grade (%)		-1%	1%		1%	
Storage Length (ft)	225			210	0	415
Storage Lanes	1			1	2	1
Taper Length (ft)	75				75	
Lane Util. Factor	1.00	0.95	0.95	1.00	0.97	1.00
Frnt				0.850		0.850
Flt Protected	0.950				0.950	
Satd. Flow (prot)	1573	3290	3257	1472	3301	1542
Flt Permitted	0.251				0.950	
Satd. Flow (perm)	415	3290	3257	1472	3301	1542
Right Turn on Red				Yes		Yes
Satd. Flow (RTOR)				534		74
Link Speed (mph)		45	45		35	
Link Distance (ft)		475	550		970	
Travel Time (s)		7.2	8.3		18.9	
Peak Hour Factor	0.93	0.93	0.93	0.93	0.93	0.93
Heavy Vehicles (%)	2%	1%	1%	0%	0%	2%
Adj. Flow (vph)	166	914	808	538	509	159
Shared Lane Traffic (%)						
Lane Group Flow (vph)	166	914	808	538	509	159
Number of Detectors	1	1	1	1	1	1
Detector Template						
Leading Detector (ft)	35	5	5	5	35	35
Trailing Detector (ft)	-5	0	0	0	-5	-5
Detector 1 Position(ft)	-5	0	0	0	-5	-5
Detector 1 Size(ft)	40	5	5	5	40	40
Detector 1 Type	CI+Ex	CI+Ex	CI+Ex	CI+Ex	CI+Ex	CI+Ex
Detector 1 Channel						
Detector 1 Extend (s)	0.0	0.0	0.0	0.0	0.0	0.0
Detector 1 Queue (s)	0.0	0.0	0.0	0.0	0.0	0.0
Detector 1 Delay (s)	0.0	0.0	0.0	0.0	0.0	0.0
Turn Type	pm+pt	NA	NA	pm+ov	Prot	pm+ov
Protected Phases	5	2	6	4	4	5
Permitted Phases	2			6		4
Detector Phase	5	2	6	4	4	5
Switch Phase						
Minimum Initial (s)	3.0	20.0	20.0	7.0	7.0	3.0
Minimum Split (s)	9.0	26.0	26.0	14.0	14.0	9.0
Total Split (s)	23.0	68.0	45.0	32.0	32.0	23.0
Total Split (%)	23.0%	68.0%	45.0%	32.0%	32.0%	23.0%
Yellow Time (s)	4.0	4.0	4.0	4.0	4.0	4.0
All-Red Time (s)	2.0	2.0	2.0	3.0	3.0	2.0
Lost Time Adjust (s)	-1.0	-1.0	-1.0	-1.0	-1.0	-1.0
Total Lost Time (s)	5.0	5.0	5.0	6.0	6.0	5.0
Lead/Lag	Lead		Lag		Lead	



Lane Group	EBL	EBT	WBT	WBR	SBL	SBR
Lead-Lag Optimize?						
Recall Mode	None	C-Max	C-Max	None	None	None
Act Effct Green (s)	66.2	66.2	50.4	78.2	22.8	39.6
Actuated g/C Ratio	0.66	0.66	0.50	0.78	0.23	0.40
v/c Ratio	0.42	0.42	0.49	0.42	0.68	0.24
Control Delay	10.1	6.7	19.3	3.6	39.8	10.6
Queue Delay	0.0	0.0	0.0	0.2	0.0	0.0
Total Delay	10.1	6.7	19.3	3.8	39.8	10.6
LOS	B	A	B	A	D	B
Approach Delay		7.2	13.1		32.8	
Approach LOS		A	B		C	
Queue Length 50th (ft)	30	90	223	20	152	34
Queue Length 95th (ft)	53	120	301	49	200	69
Internal Link Dist (ft)		395	470		890	
Turn Bay Length (ft)	225			210		415
Base Capacity (vph)	483	2177	1642	1297	858	761
Starvation Cap Reductn	0	0	0	201	0	0
Spillback Cap Reductn	0	73	0	0	0	0
Storage Cap Reductn	0	0	0	0	0	0
Reduced v/c Ratio	0.34	0.43	0.49	0.49	0.59	0.21

Intersection Summary

Area Type: Other
 Cycle Length: 100
 Actuated Cycle Length: 100
 Offset: 38 (38%), Referenced to phase 2:EBTL and 6:WBT, Start of 1st Green
 Natural Cycle: 55
 Control Type: Actuated-Coordinated
 Maximum v/c Ratio: 0.68
 Intersection Signal Delay: 15.3
 Intersection Capacity Utilization 58.5%
 Analysis Period (min) 15

Intersection LOS: B
 ICU Level of Service B

Splits and Phases: 2: Welsh Road & Dresher Road

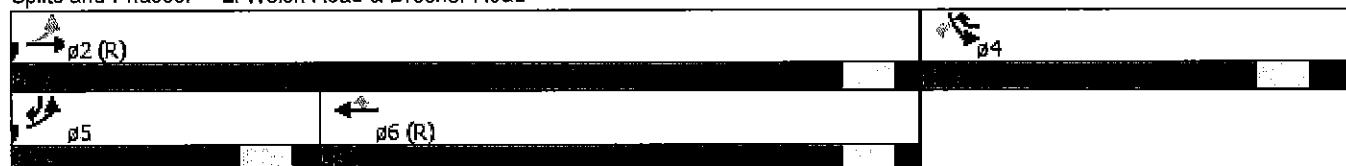

BT Dreshertown, LP
3: Dreshertown Road & Welsh Road

2023 With SAT Peak



Lane Group	EBT	EBR	WBL	WBT	NBL	NBR
Lane Configurations	↑↑	↑	↓	↑↑	↑↓	↑
Volume (vph)	1055	268	222	994	258	263
Ideal Flow (vphpl)	1800	1800	1800	1800	1800	1800
Lane Width (ft)	11	15	10	12	12	15
Grade (%)	-2%			1%	1%	
Storage Length (ft)		150	175		0	350
Storage Lanes		1	1		2	2
Taper Length (ft)			75		75	
Lane Util. Factor	0.95	1.00	1.00	0.95	0.97	1.00
Frnt		0.850				0.850
Flt Protected			0.950		0.950	
Satd. Flow (prot)	3339	1683	1588	3403	3301	1675
Flt Permitted			0.156		0.950	
Satd. Flow (perm)	3339	1683	261	3403	3301	1675
Right Turn on Red		Yes				Yes
Satd. Flow (RTOR)		230				39
Link Speed (mph)	45			45	40	
Link Distance (ft)	550			523	600	
Travel Time (s)	8.3			7.9	10.2	
Peak Hour Factor	0.91	0.91	0.91	0.91	0.91	0.91
Heavy Vehicles (%)	0%	1%	0%	0%	0%	0%
Adj. Flow (vph)	1159	295	244	1092	284	289
Shared Lane Traffic (%)						
Lane Group Flow (vph)	1159	295	244	1092	284	289
Number of Detectors	1	1	1	1	1	1
Detector Template						
Leading Detector (ft)	5	5	35	5	35	35
Trailing Detector (ft)	0	0	-5	0	-5	-5
Detector 1 Position(ft)	0	0	-5	0	-5	-5
Detector 1 Size(ft)	5	5	40	5	40	40
Detector 1 Type	Cl+Ex	Cl+Ex	Cl+Ex	Cl+Ex	Cl+Ex	Cl+Ex
Detector 1 Channel						
Detector 1 Extend (s)	0.0	0.0	0.0	0.0	0.0	0.0
Detector 1 Queue (s)	0.0	0.0	0.0	0.0	0.0	0.0
Detector 1 Delay (s)	0.0	0.0	0.0	0.0	0.0	0.0
Turn Type	NA	Perm	pm+pt	NA	Prot	pm+ov
Protected Phases	2		1	6	8	1
Permitted Phases		2	6			8
Detector Phase	2	2	1	6	8	1
Switch Phase						
Minimum Initial (s)	20.0	20.0	3.0	20.0	7.0	3.0
Minimum Split (s)	27.0	27.0	10.0	27.0	14.0	10.0
Total Split (s)	53.0	53.0	29.0	82.0	18.0	29.0
Total Split (%)	53.0%	53.0%	29.0%	82.0%	18.0%	29.0%
Yellow Time (s)	5.0	5.0	5.0	5.0	4.0	5.0
All-Red Time (s)	2.0	2.0	2.0	2.0	3.0	2.0
Lost Time Adjust (s)	-1.0	-1.0	-1.0	-1.0	-1.0	-1.0
Total Lost Time (s)	6.0	6.0	6.0	6.0	6.0	6.0
Lead/Lag	Lag	Lag	Lead			Lead

BT Dreshertown, LP
 3: Dreshertown Road & Welsh Road

2023 With SAT Peak



Lane Group	EBT	EBR	WBL	WBT	NBL	NBR
------------	-----	-----	-----	-----	-----	-----

Lead-Lag Optimize?						
Recall Mode	C-Max	C-Max	None	C-Max	None	None

Intersection Summary

Area Type: Other
 Cycle Length: 100
 Actuated Cycle Length: 100
 Offset: 28 (28%), Referenced to phase 2:EBT and 6:WBTL, Start of 1st Green
 Natural Cycle: 60
 Control Type: Actuated-Coordinated

Splits and Phases: 3: Dreshertown Road & Welsh Road

φ1	φ2 (R)	
φ5 (R)		φ8



Movement	EBT	EBR	WBL	WBT	NEB	NEB
Lane Configurations	↑↑	↑	↑	↑↑	↑↑	↑
Volume (veh/h)	1055	268	222	994	258	263
Number	2	12	1	6	3	18
Initial Q (Qb), veh	0	0	0	0	0	0
Ped-Bike Adj(A_pbT)		1.00	1.00		1.00	1.00
Parking Bus, Adj	1.00	1.00	1.00	1.00	1.00	1.00
Adj Sat Flow, veh/h/ln	1818	1872	1791	1791	1791	1863
Adj Flow Rate, veh/h	1159	295	244	1092	284	203
Adj No. of Lanes	2	1	1	2	2	1
Peak Hour Factor	0.91	0.91	0.91	0.91	0.91	0.91
Percent Heavy Veh, %	0	1	0	0	0	0
Cap, veh/h	2104	969	452	2586	397	334
Arrive On Green	1.00	1.00	0.18	1.00	0.12	0.12
Sat Flow, veh/h	3545	1591	1706	3492	3309	1583
Grp Volume(v), veh/h	1159	295	244	1092	284	203
Grp Sat Flow(s),veh/h/ln	1727	1591	1706	1701	1655	1583
Q Serve(g_s), s	0.0	0.0	5.0	0.0	8.3	11.6
Cycle Q Clear(g_c), s	0.0	0.0	5.0	0.0	8.3	11.6
Prop In Lane		1.00	1.00		1.00	1.00
Lane Grp Cap(c), veh/h	2104	969	452	2586	397	334
V/C Ratio(X)	0.55	0.30	0.54	0.42	0.72	0.61
Avail Cap(c_a), veh/h	2104	969	689	2586	397	334
HCM Platoon Ratio	2.00	2.00	2.00	2.00	1.00	1.00
Upstream Filter(I)	0.85	0.85	1.00	1.00	0.95	0.95
Uniform Delay (d), s/veh	0.0	0.0	4.1	0.0	42.4	35.7
Incr Delay (d2), s/veh	0.9	0.7	1.0	0.5	5.7	3.0
Initial Q Delay(d3),s/veh	0.0	0.0	0.0	0.0	0.0	0.0
%ile BackOfQ(95%),veh/ln	0.5	0.3	4.2	0.3	7.3	9.0
LnGrp Delay(d),s/veh	0.9	0.7	5.1	0.5	48.1	38.7
LnGrp LOS	A	A	A	A	D	D
Approach Vol, veh/h	1454			1336	487	
Approach Delay, s/veh	0.8			1.3	44.2	
Approach LOS	A			A	D	

Timer	1	2	3	4	5	6	7	8
Assigned Phs	1	2				6		8
Phs Duration (G+Y+Rc), s	15.1	66.9				82.0		18.0
Change Period (Y+Rc), s	7.0	7.0				7.0		7.0
Max Green Setting (Gmax), s	22.0	46.0				75.0		11.0
Max Q Clear Time (g_c+1), s	7.5	2.5				2.5		14.1
Green Ext Time (p_c), s	0.6	11.9				12.5		0.0

Intersection Summary	
HCM 2010 Ctrl Delay	7.5
HCM 2010 LOS	A

BT Dreshertown, LP
4: Dryden Road & Welsh Road

2023 With SAT Peak



Lane Group	EBL	EBT	EBR	WBL	WBT	WBR	NEL	NBT	NBR	SBL	SET	SBR
Lane Configurations												
Volume (vph)	2	1129	93	310	1003	2	225	0	188	2	0	2
Ideal Flow (vphpl)	1800	1800	1800	1800	1800	1800	1800	1800	1800	1800	1800	1800
Lane Width (ft)	10	12	14	10	12	12	11	15	15	12	14	14
Grade (%)		-1%			-1%			-1%			0%	
Storage Length (ft)	150		225	175		0	110		0	150		0
Storage Lanes	1		1	1		0	1		0	1		0
Taper Length (ft)	75			75			75			75		
Lane Util. Factor	1.00	0.95	1.00	1.00	0.95	0.95	1.00	1.00	1.00	1.00	1.00	1.00
Frt			0.850					0.850			0.850	
Flt Protected	0.950			0.950			0.950			0.950		
Satd. Flow (prot)	1604	3437	1640	1604	3437	0	1661	1691	0	1710	1632	0
Flt Permitted	0.225			0.188			0.757			0.426		
Satd. Flow (perm)	380	3437	1640	317	3437	0	1324	1691	0	767	1632	0
Right Turn on Red			Yes			Yes			Yes			Yes
Satd. Flow (RTOR)			103					109			142	
Link Speed (mph)		45			45			25			25	
Link Distance (ft)		517			1416			754			960	
Travel Time (s)		7.8			21.5			20.6			26.2	
Peak Hour Factor	0.90	0.90	0.90	0.90	0.90	0.90	0.90	0.90	0.90	0.90	0.90	0.90
Heavy Vehicles (%)	0%	0%	0%	0%	0%	0%	0%	0%	0%	0%	0%	0%
Adj. Flow (vph)	2	1254	103	344	1114	2	250	0	209	2	0	2
Shared Lane Traffic (%)												
Lane Group Flow (vph)	2	1254	103	344	1116	0	250	209	0	2	2	0
Number of Detectors	1	1	1	1	1		1	1		1	1	
Detector Template												
Leading Detector (ft)	5	5	5	5	5		35	35		35	35	
Trailing Detector (ft)	0	0	0	0	0		-5	-5		-5	-5	
Detector 1 Position(ft)	0	0	0	0	0		-5	-5		-5	-5	
Detector 1 Size(ft)	5	5	5	5	5		40	40		40	40	
Detector 1 Type	CI+Ex	CI+Ex	CI+Ex	CI+Ex	CI+Ex		CI+Ex	CI+Ex		CI+Ex	CI+Ex	
Detector 1 Channel												
Detector 1 Extend (s)	0.0	0.0	0.0	0.0	0.0		0.0	0.0		0.0	0.0	
Detector 1 Queue (s)	0.0	0.0	0.0	0.0	0.0		0.0	0.0		0.0	0.0	
Detector 1 Delay (s)	0.0	0.0	0.0	0.0	0.0		0.0	0.0		0.0	0.0	
Turn Type	Perm	NA	Perm	Perm	NA		Perm	NA		Perm	NA	
Protected Phases		2			6			8			4	
Permitted Phases	2		2	6			8			4		
Detector Phase	2	2	2	6	6		8	8		4	4	
Switch Phase												
Minimum Initial (s)	21.0	21.0	21.0	21.0	21.0		5.0	5.0		5.0	5.0	
Minimum Split (s)	27.0	27.0	27.0	27.0	27.0		11.0	11.0		11.0	11.0	
Total Split (s)	77.0	77.0	77.0	77.0	77.0		23.0	23.0		23.0	23.0	
Total Split (%)	77.0%	77.0%	77.0%	77.0%	77.0%		23.0%	23.0%		23.0%	23.0%	
Yellow Time (s)	4.0	4.0	4.0	4.0	4.0		3.0	3.0		3.0	3.0	
All-Red Time (s)	2.0	2.0	2.0	2.0	2.0		3.0	3.0		3.0	3.0	
Lost Time Adjust (s)	-1.0	-1.0	-1.0	-1.0	-1.0		-1.0	-1.0		-1.0	-1.0	
Total Lost Time (s)	5.0	5.0	5.0	5.0	5.0		5.0	5.0		5.0	5.0	
Lead/Lag												



Lane Group	EBL	EBT	EBR	WBL	WBT	WBR	NBL	NBT	NBR	SBL	SBT	SBR
Lead-Lag Optimize?												
Recall Mode	C-Max	C-Max	C-Max	C-Max	C-Max		None	None		None	None	

Intersection Summary

Area Type: Other
 Cycle Length: 100
 Actuated Cycle Length: 100
 Offset: 23 (23%), Referenced to phase 2:EBTL and 6:WBTL, Start of 1st Green
 Natural Cycle: 150
 Control Type: Actuated-Coordinated

Splits and Phases: 4: Dryden Road & Welsh Road

p2 (R)	p4
p6 (R)	p8



Movement	EBL	EBT	EBR	WBL	WBT	WBR	NEL	NET	NBR	SBL	SBT	SBR
Lane Configurations	↖	↗	↘	↖	↗		↖	↗		↖	↗	
Volume (veh/h)	2	1129	93	310	1003	2	225	0	188	2	0	2
Number	5	2	12	1	6	16	3	8	18	7	4	14
Initial Q (Qb), veh	0	0	0	0	0	0	0	0	0	0	0	0
Ped-Bike Adj(A_pbT)	1.00		1.00	1.00		1.00	1.00		1.00	1.00		1.00
Parking Bus, Adj	1.00	1.00	1.00	1.00	1.00	1.00	1.00	1.00	1.00	1.00	1.00	1.00
Adj Sat Flow, veh/h/ln	1809	1809	1881	1809	1809	1809	1809	1881	1881	1800	1872	1872
Adj Flow Rate, veh/h	2	1254	101	344	1114	2	250	0	209	2	0	2
Adj No. of Lanes	1	2	1	1	2	0	1	1	0	1	1	0
Peak Hour Factor	0.90	0.90	0.90	0.90	0.90	0.90	0.90	0.90	0.90	0.90	0.90	0.90
Percent Heavy Veh, %	0	0	0	0	0	0	0	0	0	0	0	0
Cap, veh/h	376	2475	1151	368	2534	5	332	0	288	145	0	286
Arrive On Green	1.00	1.00	1.00	0.72	0.72	0.71	0.18	0.00	0.17	0.18	0.00	0.17
Sat Flow, veh/h	515	3437	1599	411	3520	6	1445	0	1599	1191	0	1591
Grp Volume(v), veh/h	2	1254	101	344	544	572	250	0	209	2	0	2
Grp Sat Flow(s),veh/h/ln	515	1719	1599	411	1719	1808	1445	0	1599	1191	0	1591
Q Serve(g_s), s	0.1	0.0	0.0	72.0	13.0	13.0	17.2	0.0	12.4	0.2	0.0	0.1
Cycle Q Clear(g_c), s	13.0	0.0	0.0	72.0	13.0	13.0	17.2	0.0	12.4	12.0	0.0	0.1
Prop In Lane	1.00		1.00	1.00		0.00	1.00		1.00	1.00		1.00
Lane Grp Cap(c), veh/h	376	2475	1151	368	1237	1302	332	0	288	145	0	286
V/C Ratio(X)	0.01	0.51	0.09	0.94	0.44	0.44	0.75	0.00	0.73	0.01	0.00	0.01
Avail Cap(c_a), veh/h	376	2475	1151	368	1237	1302	332	0	288	145	0	286
HCM Platoon Ratio	2.00	2.00	2.00	1.00	1.00	1.00	1.00	1.00	1.00	1.00	1.00	1.00
Upstream Filter(I)	1.00	1.00	1.00	1.00	1.00	1.00	1.00	0.00	1.00	1.00	0.00	1.00
Uniform Delay (d), s/veh	1.2	0.0	0.0	19.1	5.7	5.7	40.7	0.0	39.2	44.1	0.0	34.1
Incr Delay (d2), s/veh	0.0	0.7	0.2	33.2	1.1	1.1	9.3	0.0	8.8	0.0	0.0	0.0
Initial Q Delay(d3),s/veh	0.0	0.0	0.0	0.0	0.0	0.0	0.0	0.0	0.0	0.0	0.0	0.0
%ile BackOfQ(95%),veh/ln	0.0	0.5	0.1	18.7	10.6	11.0	12.2	0.0	10.3	0.1	0.0	0.1
LnGrp Delay(d),s/veh	1.2	0.7	0.2	52.3	6.9	6.8	50.0	0.0	48.0	44.2	0.0	34.1
LnGrp LOS	A	A	A	D	A	A	D		D	D		C
Approach Vol, veh/h		1357			1460			459				4
Approach Delay, s/veh		0.7			17.5			49.1				39.1
Approach LOS		A			B			D				D

Timer	1	2	3	4	5	6	7	8
Assigned Phs		2		4		6		8
Phs Duration (G+Y+Rc), s		77.0		23.0		77.0		23.0
Change Period (Y+Rc), s		6.0		6.0		6.0		6.0
Max Green Setting (Gmax), s		71.0		17.0		71.0		17.0
Max Q Clear Time (g_c+I1), s		15.5		14.5		74.5		19.7
Green Ext Time (p_c), s		22.9		0.5		0.0		0.0

Intersection Summary	
HCM 2010 Ctrl Delay	15.0
HCM 2010 LOS	B

BT Dreshertown, LP
 5: Dreshertown Road & Dryden Road

2023 With SAT Peak



Lane Group	WBL	WER	NBT	NBR	SBL	SET
Lane Configurations						
Volume (vph)	171	108	413	192	115	375
Ideal Flow (vphpl)	1800	1800	1800	1800	1800	1800
Lane Width (ft)	12	14	12	14	12	12
Grade (%)	0%		1%			0%
Storage Length (ft)	0	200		225	175	
Storage Lanes	1	1		1	1	
Taper Length (ft)	75				75	
Lane Util. Factor	1.00	1.00	1.00	1.00	1.00	1.00
Frt		0.850		0.850		
Flt Protected	0.950				0.950	
Satd. Flow (prof)	1710	1632	1791	1624	1710	1800
Flt Permitted	0.950				0.469	
Satd. Flow (perm)	1710	1632	1791	1624	844	1800
Right Turn on Red		Yes		Yes		
Satd. Flow (RTOR)		119		211		
Link Speed (mph)	25		40			40
Link Distance (ft)	593		817			600
Travel Time (s)	16.2		13.9			10.2
Peak Hour Factor	0.91	0.91	0.91	0.91	0.91	0.91
Heavy Vehicles (%)	0%	0%	0%	0%	0%	0%
Adj. Flow (vph)	188	119	454	211	126	412
Shared Lane Traffic (%)						
Lane Group Flow (vph)	188	119	454	211	126	412
Number of Detectors	1	1	1	1	1	1
Detector Template	Left	Right	Thru	Right	Left	Thru
Leading Detector (ft)	35	35	5	5	35	5
Trailing Detector (ft)	-5	-5	0	0	-5	0
Detector 1 Position(ft)	-5	-5	0	0	-5	0
Detector 1 Size(ft)	40	40	5	5	40	5
Detector 1 Type	CI+Ex	CI+Ex	CI+Ex	CI+Ex	CI+Ex	CI+Ex
Detector 1 Channel						
Detector 1 Extend (s)	0.0	0.0	0.0	0.0	0.0	0.0
Detector 1 Queue (s)	0.0	0.0	0.0	0.0	0.0	0.0
Detector 1 Delay (s)	0.0	0.0	0.0	0.0	0.0	0.0
Turn Type	Prot	Perm	NA	Perm	Perm	NA
Protected Phases	8		2			6
Permitted Phases		8		2	6	
Detector Phase	8	8	2	2	6	6
Switch Phase						
Minimum Initial (s)	15.0	15.0	20.0	20.0	20.0	20.0
Minimum Split (s)	21.0	21.0	26.0	26.0	26.0	26.0
Total Split (s)	34.0	34.0	66.0	66.0	66.0	66.0
Total Split (%)	34.0%	34.0%	66.0%	66.0%	66.0%	66.0%
Yellow Time (s)	4.0	4.0	4.0	4.0	4.0	4.0
All-Red Time (s)	2.0	2.0	2.0	2.0	2.0	2.0
Lost Time Adjust (s)	-1.0	-1.0	-1.0	-1.0	-1.0	-1.0
Total Lost Time (s)	5.0	5.0	5.0	5.0	5.0	5.0
Lead/Lag						



Lane Group	WBL	WBR	NBT	NBR	SBL	SBT
Lead-Lag Optimize?						
Recall Mode	None	None	C-Max	C-Max	C-Max	C-Max

Intersection Summary

Area Type: Other
 Cycle Length: 100
 Actuated Cycle Length: 100
 Offset: 0 (0%), Referenced to phase 2:NBT and 6:SBTL, Start of 1st Green
 Natural Cycle: 50
 Control Type: Actuated-Coordinated

Splits and Phases: 5: Dreshertown Road & Dryden Road

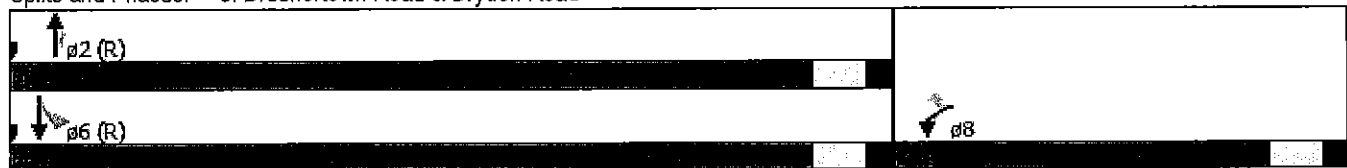



Movement	WBL	WBR	NET	NER	SBI	SBT
Lane Configurations	↖	↗	↑	↗	↖	↑
Volume (veh/h)	171	108	413	192	115	375
Number	3	18	2	12	1	6
Initial Q (Qb), veh	0	0	0	0	0	0
Ped-Bike Adj(A_pbT)	1.00	1.00		1.00	1.00	
Parking Bus, Adj	1.00	1.00	1.00	1.00	1.00	1.00
Adj Sat Flow, veh/h/ln	1800	1872	1791	1863	1800	1800
Adj Flow Rate, veh/h	188	119	454	211	126	412
Adj No. of Lanes	1	1	1	1	1	1
Peak Hour Factor	0.91	0.91	0.91	0.91	0.91	0.91
Percent Heavy Veh, %	0	0	0	0	0	0
Cap, veh/h	274	255	1325	1172	582	1332
Arrive On Green	0.16	0.16	0.74	0.74	0.74	0.74
Sat Flow, veh/h	1714	1591	1791	1583	783	1800
Grp Volume(v), veh/h	188	119	454	211	126	412
Grp Sat Flow(s),veh/h/ln	1714	1591	1791	1583	783	1800
Q Serve(g_s), s	10.3	6.8	8.8	4.0	6.7	7.7
Cycle Q Clear(g_c), s	10.3	6.8	8.8	4.0	15.5	7.7
Prop In Lane	1.00	1.00		1.00	1.00	
Lane Grp Cap(c), veh/h	274	255	1325	1172	582	1332
V/C Ratio(X)	0.69	0.47	0.34	0.18	0.22	0.31
Avail Cap(c_a), veh/h	497	461	1325	1172	582	1332
HCM Platoon Ratio	1.00	1.00	1.00	1.00	1.00	1.00
Upstream Filter(l)	1.00	1.00	1.00	1.00	0.90	0.90
Uniform Delay (d), s/veh	39.6	38.1	4.5	3.9	7.2	4.4
Incr Delay (d2), s/veh	3.0	1.3	0.7	0.3	0.8	0.5
Initial Q Delay(d3),s/veh	0.0	0.0	0.0	0.0	0.0	0.0
%ile BackOfQ(95%),veh/ln	8.9	5.5	8.0	3.3	2.8	7.1
LnGrp Delay(d),s/veh	42.7	39.5	5.2	4.2	8.0	4.9
LnGrp LOS	D	D	A	A	A	A
Approach Vol, veh/h	307		665			538
Approach Delay, s/veh	41.4		4.9			5.6
Approach LOS	D		A			A

Parameter	1	2	3	4	5	6	7	8
Assigned Phs		2				6		8
Phs Duration (G+Y+Rc), s		79.0				79.0		21.0
Change Period (Y+Rc), s		6.0				6.0		6.0
Max Green Setting (Gmax), s		60.0				60.0		28.0
Max Q Clear Time (g_c+1), s		11.3				18.0		12.8
Green Ext Time (p_c), s		3.9				3.9		1.0

Intersection Summary	
HCM 2010 Ctrl Delay	12.6
HCM 2010 LOS	B



Lane Group	EBT	EBP	WBL	WBT	NBT	NBP
Lane Configurations	↑↑	↑		↑↑		↑
Volume (vph)	1111	150	0	1230	0	113
Ideal Flow (vphpl)	1800	1800	1800	1800	1800	1800
Lane Width (ft)	12	14	12	12	12	12
Grade (%)	-1%			1%	0%	
Storage Length (ft)		225	0		0	0
Storage Lanes		1	0		0	1
Taper Length (ft)			75		75	
Lane Util. Factor	0.95	1.00	1.00	0.95	1.00	1.00
Frt		0.850				0.865
Flt Protected						
Satd. Flow (prot)	3437	1608	0	3403	0	1526
Flt Permitted						
Satd. Flow (perm)	3437	1608	0	3403	0	1526
Link Speed (mph)	45			45	25	
Link Distance (ft)	523			517	330	
Travel Time (s)	7.9			7.8	9.0	
Peak Hour Factor	0.90	0.90	0.90	0.90	0.90	0.90
Heavy Vehicles (%)	0%	2%	0%	0%	0%	2%
Adj. Flow (vph)	1234	167	0	1367	0	126
Shared Lane Traffic (%)						
Lane Group Flow (vph)	1234	167	0	1367	0	126
Sign Control	Free			Free	Stop	

Intersection Summary

Area Type: Other
Control Type: Unsignalized

Intersection

Int Delay, s/veh 0.7

Movement	EBT	EBR	WBL	WBT	NBL	NBR
Vol, veh/h	1111	150	0	1230	0	113
Conflicting Peds, #/hr	0	0	0	0	0	0
Sign Control	Free	Free	Free	Free	Stop	Stop
RT Channelized	-	None	-	None	-	None
Storage Length	-	225	-	-	-	0
Veh in Median Storage, #	0	-	-	0	0	-
Grade, %	-1	-	-	1	0	-
Peak Hour Factor	90	90	90	90	90	90
Heavy Vehicles, %	0	2	0	0	0	2
Mvmt Flow	1234	167	0	1367	0	126

Major/Minor	Major1	Major2	Minor1	Minor2
Conflicting Flow All	0	0	1234	0
Stage 1	-	-	-	-
Stage 2	-	-	-	-
Critical Hdwy	-	-	4.1	-
Critical Hdwy Stg 1	-	-	-	-
Critical Hdwy Stg 2	-	-	-	-
Follow-up Hdwy	-	-	2.2	-
Pot Cap-1 Maneuver	-	-	572	-
Stage 1	-	-	-	-
Stage 2	-	-	-	-
Platoon blocked, %	-	-	-	-
Mov Cap-1 Maneuver	-	-	572	-
Mov Cap-2 Maneuver	-	-	-	-
Stage 1	-	-	-	-
Stage 2	-	-	-	-

Approach	EB	WB	NB
HCM Control Delay, s	0	0	15.8
HCM LOS			C

Minor Lane/Major Mvmt	NBLn1	EBT	EBR	WBL	WBT
Capacity (veh/h)	459	-	-	572	-
HCM Lane V/C Ratio	0.274	-	-	-	-
HCM Control Delay (s)	15.8	-	-	0	-
HCM Lane LOS	C	-	-	A	-
HCM 95th %tile Q(veh)	1.1	-	-	0	-

APPENDIX L

Previously Approved Development Analysis

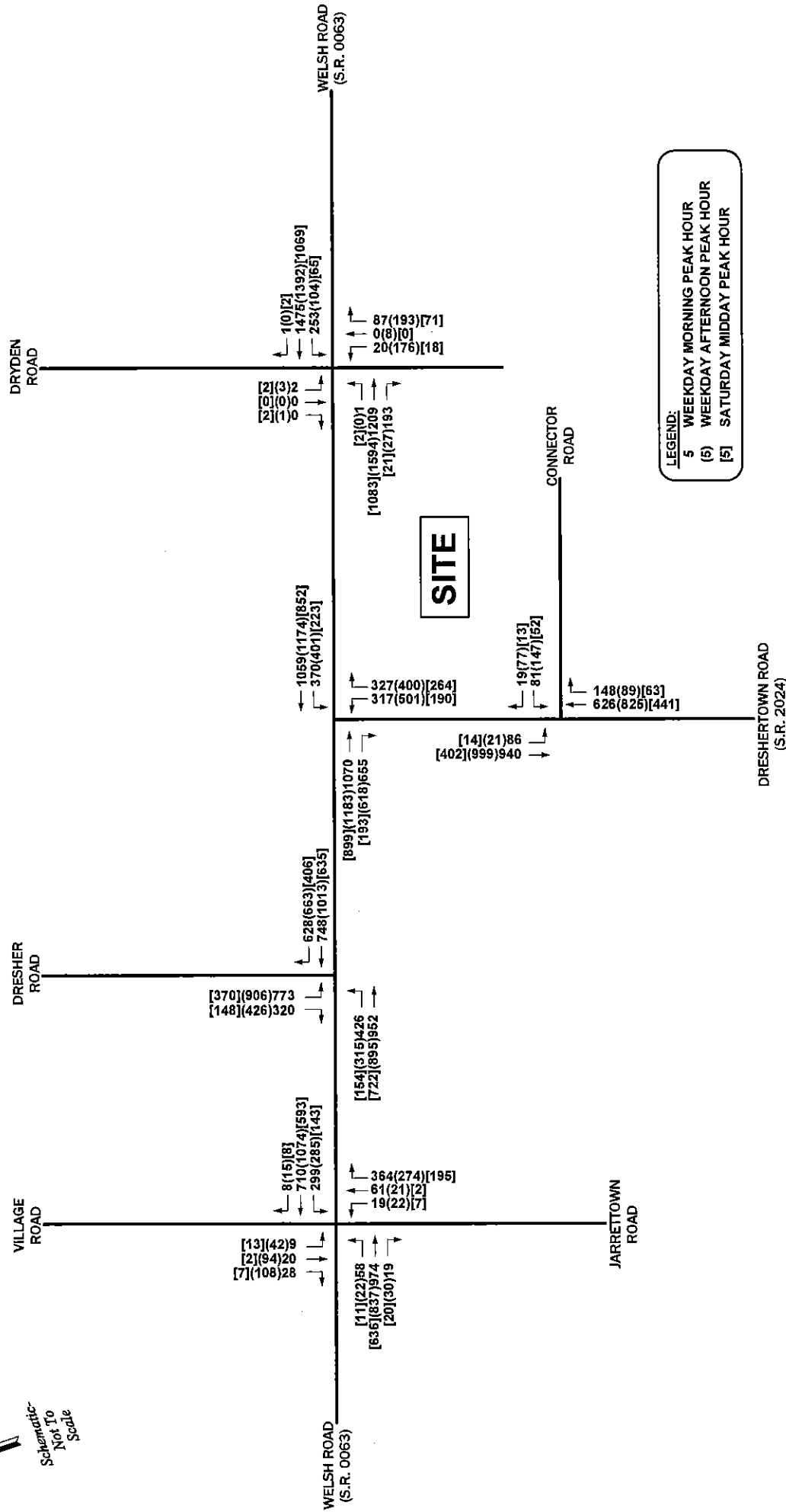
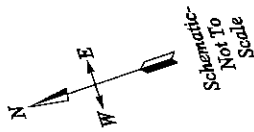

LEGEND:
 5 WEEKDAY MORNING PEAK HOUR
 (6) WEEKDAY AFTERNOON PEAK HOUR
 [5] SATURDAY MIDDAY PEAK HOUR

FIGURE 7A

2023 Future Peak Hour Traffic Volumes With Development (Age-Restricted Residential and Approved Lot 3 Office Development)

THE PROMENADE AT UPPER DUBLIN

UPPER DUBLIN TOWNSHIP, MONTGOMERY COUNTY, PA

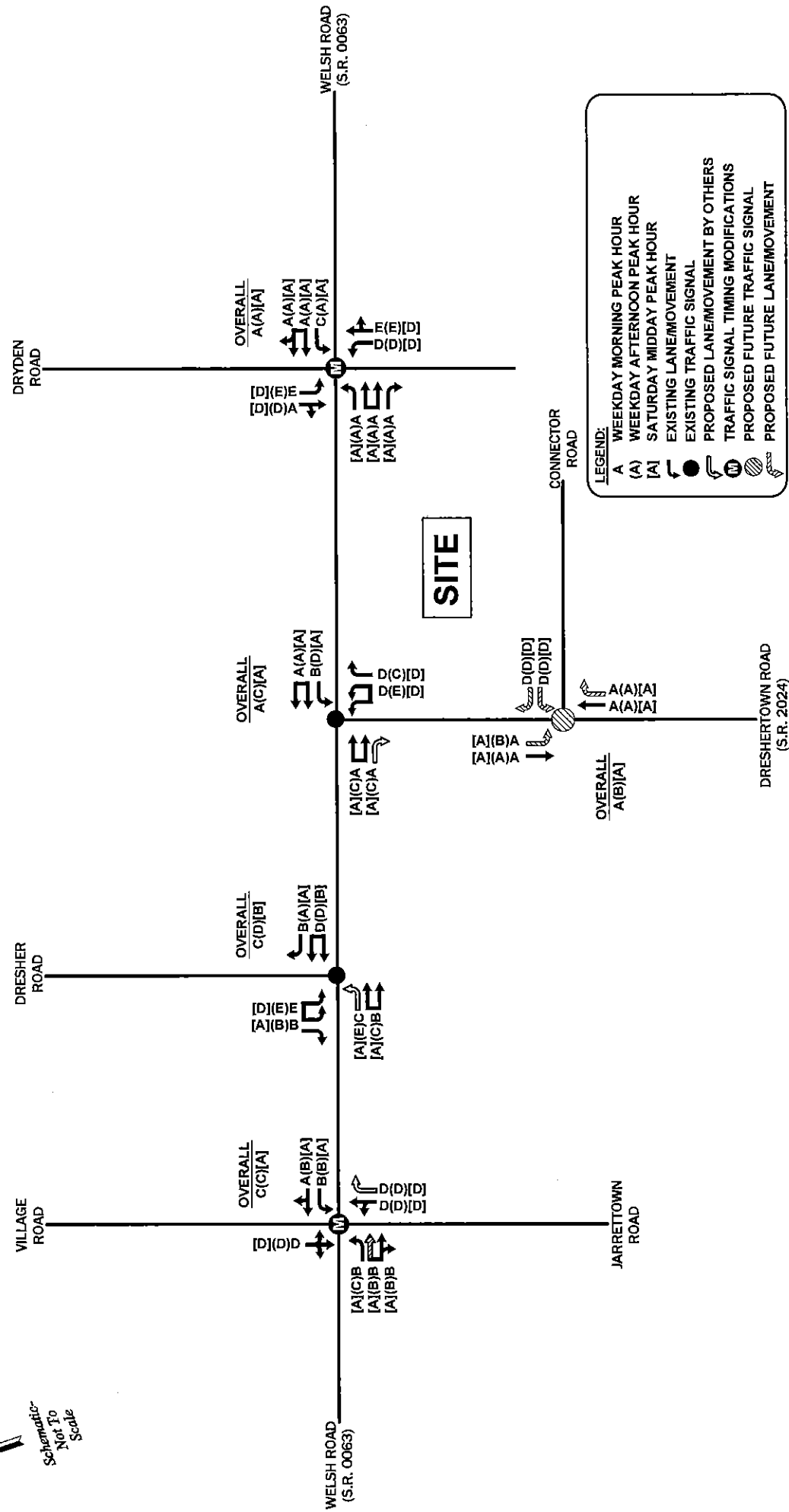
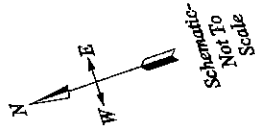

FIGURE 7B

2023 Future Levels of Service With Development (Age-Restricted Residential and Approved Lot 3 Office Development)

THE PROMENADE AT UPPER DUBLIN

UPPER DUBLIN TOWNSHIP, MONTGOMERY COUNTY, PA

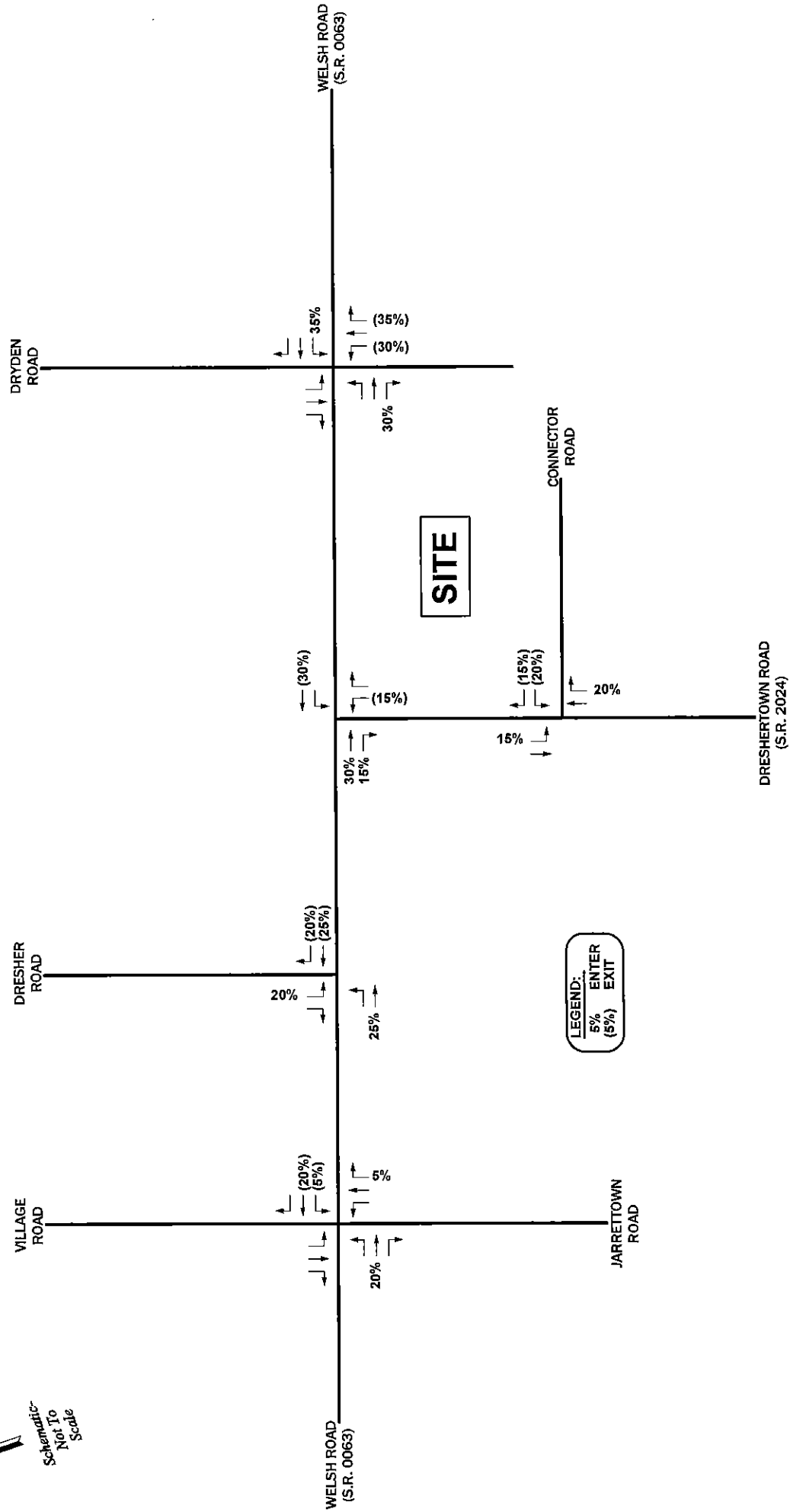
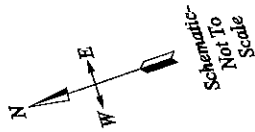

FIGURE 4G
 "New" Trip Distribution (Approved Lot 3 Office Development)
THE PROMENADE AT UPPER DUBLIN
UPPER DUBLIN TOWNSHIP, MONTGOMERY COUNTY, PA

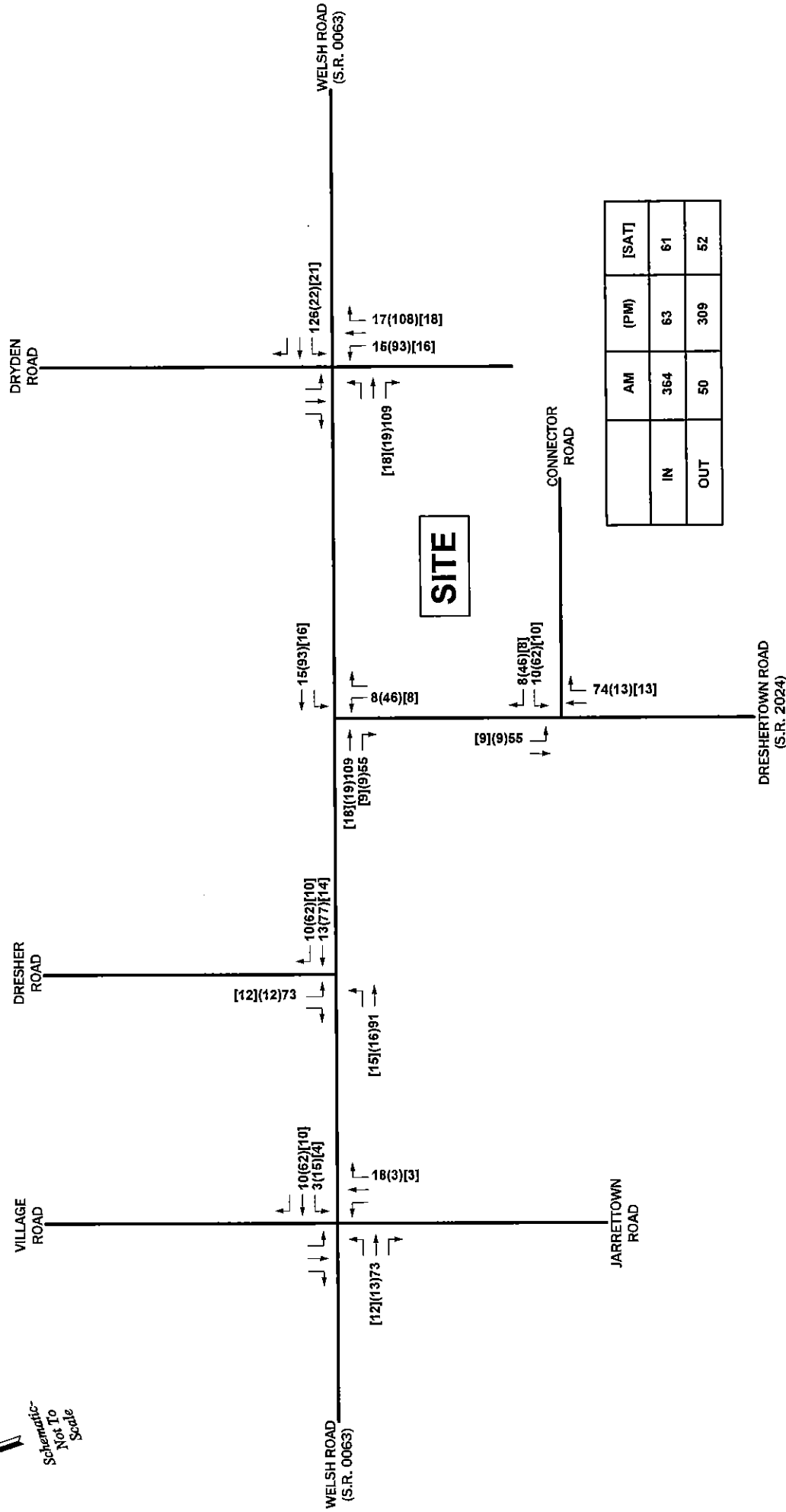
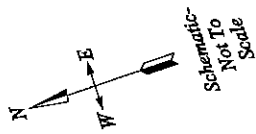

FIGURE 4H

"New" Trip Assignment (Approved Lot 3 Office Development)

THE PROMENADE AT UPPER DUBLIN

UPPER DUBLIN TOWNSHIP, MONTGOMERY COUNTY, PA



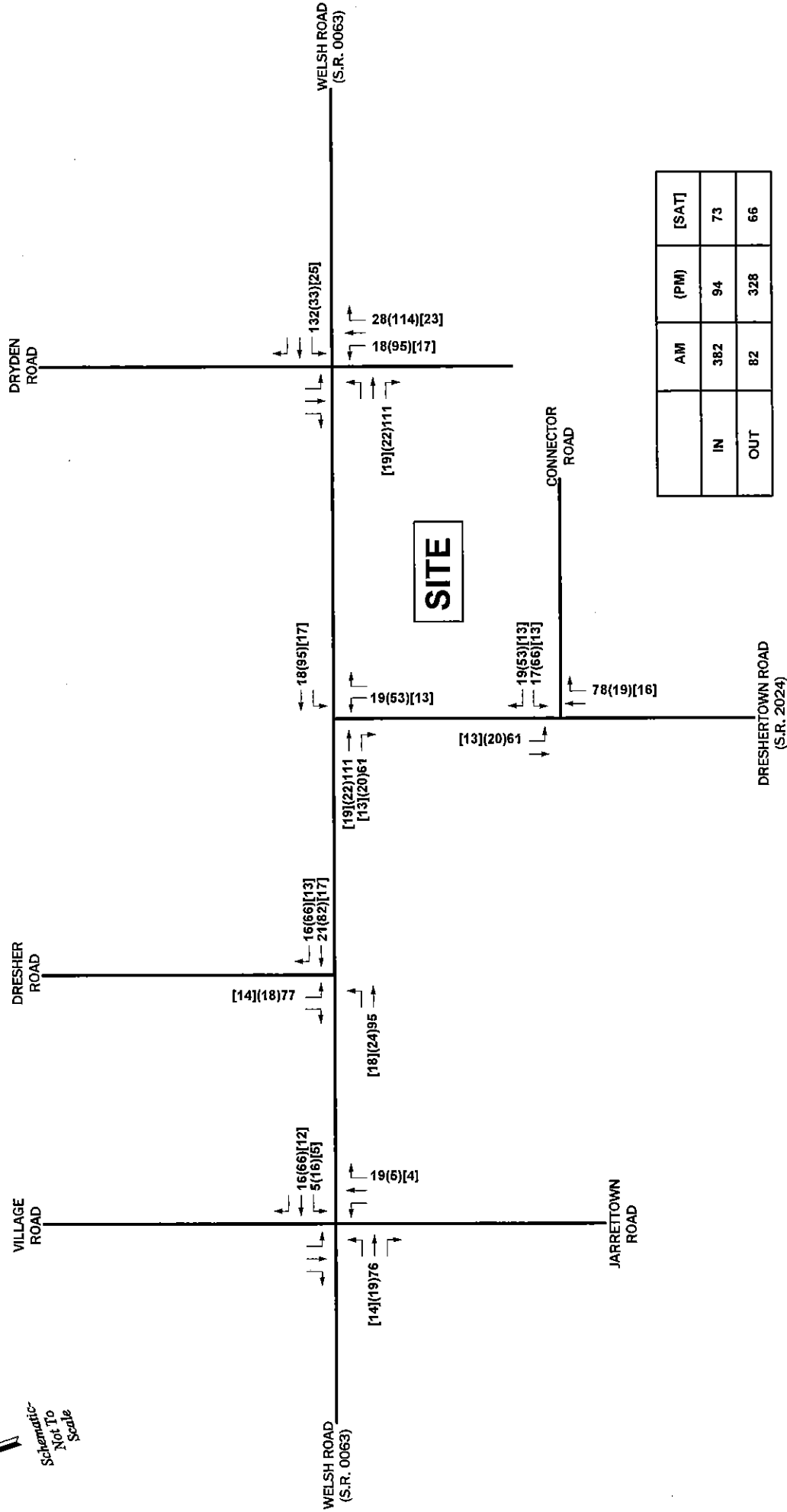
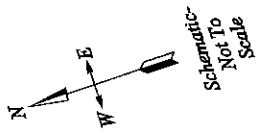

FIGURE 4I

"New" Trip Assignment (Age-Restricted Residential and Approved Lot 3 Office Development)

THE PROMENADE AT UPPER DUBLIN

UPPER DUBLIN TOWNSHIP, MONTGOMERY COUNTY, PA



1: Jarretstown Road/Village Road & Welsh Road



Lane Group	EBL	EBI	EBR	WBL	WBI	WBR	NBL	NBI	NBR	SBL	SBT	SBR
Lane Configurations	↖	↕		↖	↕		↖	↕	↗		↕	↗
Volume (vph)	58	974	19	299	710	8	19	61	364	9	20	28
Ideal Flow (vphpl)	1800	1800	1800	1800	1800	1800	1800	1800	1800	1800	1800	1800
Lane Width (ft)	12	12	12	11	14	14	12	12	14	15	15	15
Grade (%)		-6%			1%			-1%			1%	
Storage Length (ft)	150		0	100		0	0		175	0		0
Storage Lanes	1		0	1		0	0		1	0		0
Taper Length (ft)	75			75			75			75		
Lane Util. Factor	1.00	0.95	0.95	1.00	1.00	1.00	1.00	1.00	1.00	1.00	1.00	1.00
Frt		0.997			0.998			0.850		0.934		
Flt Protected	0.950			0.950				0.988		0.992		
Satd. Flow (prot)	1727	3440	0	1612	1852	0	0	1760	1640	0	1736	0
Flt Permitted	0.379			0.195				0.916		0.940		
Satd. Flow (perm)	689	3440	0	331	1852	0	0	1632	1640	0	1645	0
Right Turn on Red			Yes			Yes			Yes			Yes
Satd. Flow (RTOR)		2			1				54		29	
Link Speed (mph)		45			45			35			35	
Link Distance (ft)		1263			605			421			431	
Travel Time (s)		19.1			9.2			8.2			8.4	
Peak Hour Factor	0.95	0.95	0.95	0.95	0.95	0.95	0.95	0.95	0.95	0.95	0.95	0.95
Heavy Vehicles (%)	2%	2%	7%	2%	3%	0%	0%	2%	0%	11%	0%	7%
Adj. Flow (vph)	61	1025	20	315	747	8	20	64	383	9	21	29
Shared Lane Traffic (%)												
Lane Group Flow (vph)	61	1045	0	315	755	0	0	84	383	0	59	0
Number of Detectors	1	2		1	2		1	1	1	1	1	
Detector Template	Left			Left			Left	Thru	Right	Left	Thru	
Leading Detector (ft)	5	330		35	330		20	35	35	20	35	
Trailing Detector (ft)	0	0		-5	0		0	-5	-5	0	-5	
Detector 1 Position(ft)	0	0		-5	0		0	-5	-5	0	-5	
Detector 1 Size(ft)	5	6		40	6		20	40	40	20	40	
Detector 1 Type	CI+Ex	CI+Ex		CI+Ex	CI+Ex		CI+Ex	CI+Ex	CI+Ex	CI+Ex	CI+Ex	
Detector 1 Channel												
Detector 1 Extend (s)	0.0	0.0		0.0	0.0		0.0	0.0	0.0	0.0	0.0	
Detector 1 Queue (s)	0.0	0.0		0.0	0.0		0.0	0.0	0.0	0.0	0.0	
Detector 1 Delay (s)	0.0	0.0		0.0	0.0		0.0	0.0	0.0	0.0	0.0	
Detector 2 Position(ft)		324			324							
Detector 2 Size(ft)		6			6							
Detector 2 Type		CI+Ex			CI+Ex							
Detector 2 Channel												
Detector 2 Extend (s)		0.0			0.0							
Turn Type	Perm	NA		pm+pt	NA		Perm	NA	pm+ov	Perm	NA	
Protected Phases		2		1	6			8	1		4	
Permitted Phases	2			6			8		8	4		
Detector Phase	2	2		1	6		8	8	1	4	4	
Switch Phase												
Minimum Initial (s)	15.0	15.0		3.0	15.0		7.0	7.0	3.0	7.0	7.0	
Minimum Split (s)	22.0	22.0		10.0	22.0		13.0	13.0	10.0	13.0	13.0	
Total Split (s)	61.0	61.0		32.0	93.0		27.0	27.0	32.0	27.0	27.0	
Total Split (%)	50.8%	50.8%		26.7%	77.5%		22.5%	22.5%	26.7%	22.5%	22.5%	

1: Jarretstown Road/Village Road & Welsh Road



Lane Group	EBL	EBT	EBR	WBL	WBT	WBR	NBL	NBT	NBR	SEL	SET	SER
Maximum Green (s)	54.0	54.0		25.0	86.0		21.0	21.0	25.0	21.0	21.0	
Yellow Time (s)	5.0	5.0		5.0	5.0		4.0	4.0	5.0	4.0	4.0	
All-Red Time (s)	2.0	2.0		2.0	2.0		2.0	2.0	2.0	2.0	2.0	
Lost Time Adjust (s)	-1.0	-1.0		-1.0	-1.0			-1.0	-1.0		-1.0	
Total Lost Time (s)	6.0	6.0		6.0	6.0		5.0	6.0	5.0		5.0	
Lead/Lag	Lag	Lag		Lead				Lead				
Lead-Lag Optimize?												
Vehicle Extension (s)	3.0	3.0		3.0	3.0		3.0	3.0	3.0	3.0	3.0	
Recall Mode	C-Max	C-Max		None	C-Max		None	None	None	None	None	

Intersection Summary

Area Type: Other
 Cycle Length: 120
 Actuated Cycle Length: 120
 Offset: 33 (28%), Referenced to phase 2:EBTL and 6:WBTL, Start of 1st Green
 Natural Cycle: 60
 Control Type: Actuated-Coordinated

Splits and Phases: 1: Jarretstown Road/Village Road & Welsh Road

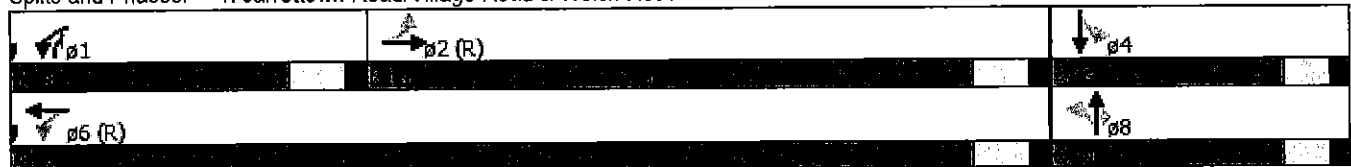

1: Jarrettown Road/Village Road & Welsh Road

Movement	EBL	EBT	EBR	WBL	WBT	WBR	NBL	NBT	NBR	SBL	SBT	SBR
Lane Configurations												
Volume (veh/h)	58	974	19	299	710	8	19	61	364	9	20	28
Number	5	2	12	1	6	16	3	8	18	7	4	14
Initial Q (Qb), veh	0	0	0	0	0	0	0	0	0	0	0	0
Ped-Bike Adj(A_pbT)	1.00		1.00	1.00		1.00	1.00		1.00	1.00		1.00
Parking_Bus, Adj	1.00	1.00	1.00	1.00	1.00	1.00	1.00	1.00	1.00	1.00	1.00	1.00
Adj Sat Flow, veh/h/ln	1818	1816	1854	1756	1809	1863	1809	1782	1881	1863	1772	1863
Adj Flow Rate, veh/h	61	1025	18	315	747	7	20	64	356	9	21	27
Adj No. of Lanes	1	2	0	1	1	0	0	1	1	0	1	0
Peak Hour Factor	0.95	0.95	0.95	0.95	0.95	0.95	0.95	0.95	0.95	0.95	0.95	0.95
Percent Heavy Veh, %	2	2	2	2	3	3	2	2	0	0	0	0
Cap, veh/h	447	1971	35	446	1297	12	89	259	464	59	124	133
Arrive On Green	0.57	0.57	0.56	0.11	0.73	0.72	0.17	0.18	0.18	0.17	0.18	0.17
Sat Flow, veh/h	728	3469	61	1672	1789	17	282	1414	1599	133	674	726
Grp Volume(v), veh/h	61	510	533	315	0	754	84	0	356	57	0	0
Grp Sat Flow(s), veh/h/ln	728	1725	1805	1672	0	1806	1696	0	1599	1533	0	0
Q Serve(g_s), s	5.1	21.7	21.7	8.5	0.0	23.7	0.0	0.0	22.0	0.0	0.0	0.0
Cycle Q Clear(g_c), s	9.5	21.7	21.7	8.5	0.0	23.7	4.9	0.0	22.0	3.6	0.0	0.0
Prop In Lane	1.00		0.03	1.00		0.01	0.24		1.00	0.16		0.47
Lane Grp Cap(c), veh/h	447	980	1025	446	0	1309	334	0	464	303	0	0
V/C Ratio(X)	0.14	0.52	0.52	0.71	0.00	0.58	0.25	0.00	0.77	0.19	0.00	0.00
Avail Cap(c_a), veh/h	447	980	1025	630	0	1309	334	0	464	303	0	0
HCM Platoon Ratio	1.00	1.00	1.00	1.00	1.00	1.00	1.00	1.00	1.00	1.00	1.00	1.00
Upstream Filter(I)	1.00	1.00	1.00	1.00	0.00	1.00	1.00	0.00	1.00	1.00	0.00	0.00
Uniform Delay (d), s/veh	14.3	15.9	15.9	12.8	0.0	7.8	42.1	0.0	38.9	41.7	0.0	0.0
Incr Delay (d2), s/veh	0.6	2.0	1.9	2.1	0.0	1.8	0.4	0.0	7.5	0.3	0.0	0.0
Initial Q Delay(d3),s/veh	0.0	0.0	0.0	0.0	0.0	0.0	0.0	0.0	0.0	0.0	0.0	0.0
%ile BackOfQ(95%),veh/ln	2.0	16.3	16.9	9.0	0.0	17.9	4.4	0.0	17.4	3.0	0.0	0.0
LnGrp Delay(d),s/veh	15.0	17.9	17.8	14.8	0.0	9.6	42.5	0.0	46.4	42.0	0.0	0.0
LnGrp LOS	B	B	B	B		A	D		D	D		
Approach Vol, veh/h		1104			1069			440			57	
Approach Delay, s/veh		17.7			11.2			45.7			42.0	
Approach LOS		B			B			D			D	
Timer	1	2	3	4	5	6	7	8				
Assigned Phs	1	2		4		6		8				
Phs Duration (G+Y+Rc), s	18.8	74.2		27.0		93.0		27.0				
Change Period (Y+Rc), s	7.0	7.0		6.0		7.0		6.0				
Max Green Setting (Gmax), s	25.0	54.0		21.0		86.0		21.0				
Max Q Clear Time (g_c+I1), s	11.0	24.2		5.6		25.7		24.5				
Green Ext Time (p_c), s	0.9	27.3		1.7		51.5		0.0				
Intersection Summary												
HCM 2010 Ctrl Delay			20.2									
HCM 2010 LOS			C									

BT Dreshertown, LP
2: Welsh Road & Dresher Road

2023 With AM Peak (Residential and Office)

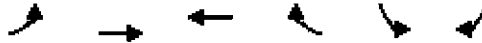

Lane Group	EBL	EBT	WBT	WBR	SBL	SBR
Lane Configurations	↖	↕	↕	↗	↖	↗
Volume (vph)	426	952	748	628	773	320
Ideal Flow (vphpl)	1800	1800	1800	1800	1800	1800
Lane Width (ft)	10	11	11	11	12	13
Grade (%)		-1%	1%		1%	
Storage Length (ft)	225			210	0	415
Storage Lanes	1			1	2	1
Taper Length (ft)	75				75	
Lane Util. Factor	1.00	0.95	0.95	1.00	0.97	1.00
Frt				0.850		0.850
Flt Protected	0.950				0.950	
Satd. Flow (prot)	1588	3290	3194	1443	3268	1542
Flt Permitted	0.167				0.950	
Satd. Flow (perm)	279	3290	3194	1443	3268	1542
Right Turn on Red				Yes		Yes
Satd. Flow (RTOR)				203		33
Link Speed (mph)		45	45		35	
Link Distance (ft)		475	550		970	
Travel Time (s)		7.2	8.3		18.9	
Peak Hour Factor	0.94	0.94	0.94	0.94	0.94	0.94
Heavy Vehicles (%)	1%	1%	3%	2%	1%	2%
Adj. Flow (vph)	453	1013	796	668	822	340
Shared Lane Traffic (%)						
Lane Group Flow (vph)	453	1013	796	668	822	340
Number of Detectors	1	1	1	1	1	1
Detector Template						
Leading Detector (ft)	35	5	5	5	35	35
Trailing Detector (ft)	-5	0	0	0	-5	-5
Detector 1 Position(ft)	-5	0	0	0	-5	-5
Detector 1 Size(ft)	40	5	5	5	40	40
Detector 1 Type	Cl+Ex	Cl+Ex	Cl+Ex	Cl+Ex	Cl+Ex	Cl+Ex
Detector 1 Channel						
Detector 1 Extend (s)	0.0	0.0	0.0	0.0	0.0	0.0
Detector 1 Queue (s)	0.0	0.0	0.0	0.0	0.0	0.0
Detector 1 Delay (s)	0.0	0.0	0.0	0.0	0.0	0.0
Turn Type	pm+pt	NA	NA	pm+ov	Prot	pm+ov
Protected Phases	5	2	6	4	4	5
Permitted Phases	2			6		4
Detector Phase	5	2	6	4	4	5
Switch Phase						
Minimum Initial (s)	3.0	20.0	20.0	7.0	7.0	3.0
Minimum Split (s)	9.0	26.0	26.0	14.0	14.0	9.0
Total Split (s)	40.0	82.0	42.0	38.0	38.0	40.0
Total Split (%)	33.3%	68.3%	35.0%	31.7%	31.7%	33.3%
Maximum Green (s)	34.0	76.0	36.0	31.0	31.0	34.0
Yellow Time (s)	4.0	4.0	4.0	4.0	4.0	4.0
All-Red Time (s)	2.0	2.0	2.0	3.0	3.0	2.0
Lost Time Adjust (s)	-1.0	-1.0	-1.0	-1.0	-1.0	-1.0
Total Lost Time (s)	5.0	5.0	5.0	6.0	6.0	5.0



Lane Group	FBI	FBT	WBT	WBR	SBL	SBR
Lead/Lag	Lead		Lag		Lead	
Lead-Lag Optimize?						
Vehicle Extension (s)	3.0	3.0	3.0	3.0	3.0	3.0
Recall Mode	None	C-Max	C-Max	None	None	None
Act Effct Green (s)	77.0	77.0	40.8	77.8	32.0	69.2
Actuated g/C Ratio	0.64	0.64	0.34	0.65	0.27	0.58
v/c Ratio	0.87	0.48	0.73	0.66	0.94	0.38
Control Delay	34.1	11.9	40.3	18.5	63.0	13.0
Queue Delay	0.0	0.2	0.0	0.5	0.0	0.0
Total Delay	34.1	12.1	40.3	19.0	63.0	13.0
LOS	C	B	D	B	E	B
Approach Delay		18.9	30.6		48.4	
Approach LOS		B	C		D	
Queue Length 50th (ft)	255	254	313	291	322	110
Queue Length 95th (ft)	#409	278	388	479	#445	169
Internal Link Dist (ft)		395	470		890	
Turn Bay Length (ft)	225			210		415
Base Capacity (vph)	560	2111	1084	1006	871	950
Starvation Cap Reductn	0	0	0	92	0	0
Spillback Cap Reductn	0	412	0	0	0	0
Storage Cap Reductn	0	0	0	0	0	0
Reduced v/c Ratio	0.81	0.60	0.73	0.73	0.94	0.36

Intersection Summary

Area Type: Other
 Cycle Length: 120
 Actuated Cycle Length: 120
 Offset: 85 (71%), Referenced to phase 2:EBTL and 6:WBT, Start of 1st Green
 Natural Cycle: 90
 Control Type: Actuated-Coordinated
 Maximum v/c Ratio: 0.94
 Intersection Signal Delay: 31.5
 Intersection LOS: C
 Intersection Capacity Utilization 83.3%
 ICU Level of Service E
 Analysis Period (min) 15
 # 95th percentile volume exceeds capacity, queue may be longer.
 Queue shown is maximum after two cycles.

Splits and Phases: 2: Welsh Road & Dresher Road

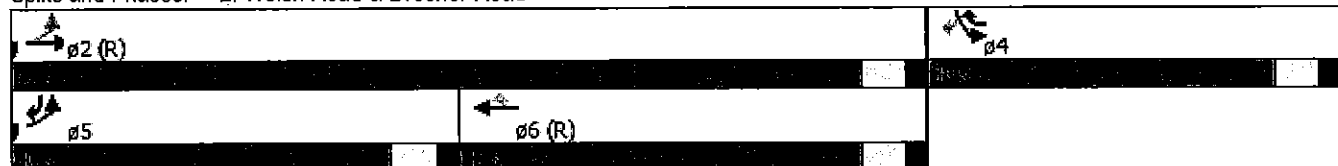

BT Dreshertown, LP
3: Dreshertown Road & Welsh Road

2023 With AM Peak (Residential and Office)



Lane Group	EBT	FBR	WBL	WBT	NBL	NBR
Lane Configurations	↑↑	↑	↓	↑↑	↓	↑
Volume (vph)	1070	655	370	1059	317	327
Ideal Flow (vphpl)	1800	1800	1800	1800	1800	1800
Lane Width (ft)	11	15	10	12	12	15
Grade (%)	-2%			1%	1%	
Storage Length (ft)		150	175		0	350
Storage Lanes		1	1		2	2
Taper Length (ft)			75		75	
Lane Util. Factor	0.95	1.00	1.00	0.95	0.97	1.00
Frt		0.850				0.850
Flt Protected			0.950		0.950	
Satd. Flow (prot)	3306	1650	1542	3304	3174	1626
Flt Permitted			0.136		0.950	
Satd. Flow (perm)	3306	1650	221	3304	3174	1626
Right Turn on Red		Yes				Yes
Satd. Flow (RTOR)		396				23
Link Speed (mph)	45			45	40	
Link Distance (ft)	550			1040	600	
Travel Time (s)	8.3			15.8	10.2	
Peak Hour Factor	0.98	0.98	0.98	0.98	0.98	0.98
Heavy Vehicles (%)	1%	3%	3%	3%	4%	3%
Adj. Flow (vph)	1092	668	378	1081	323	334
Shared Lane Traffic (%)						
Lane Group Flow (vph)	1092	668	378	1081	323	334
Number of Detectors	1	1	1	1	1	1
Detector Template						
Leading Detector (ft)	5	5	35	5	35	35
Trailing Detector (ft)	0	0	-5	0	-5	-5
Detector 1 Position(ft)	0	0	-5	0	-5	-5
Detector 1 Size(ft)	5	5	40	5	40	40
Detector 1 Type	CI+Ex	CI+Ex	CI+Ex	CI+Ex	CI+Ex	CI+Ex
Detector 1 Channel						
Detector 1 Extend (s)	0.0	0.0	0.0	0.0	0.0	0.0
Detector 1 Queue (s)	0.0	0.0	0.0	0.0	0.0	0.0
Detector 1 Delay (s)	0.0	0.0	0.0	0.0	0.0	0.0
Turn Type	NA	Perm	pm+pt	NA	Prot	pm+ov
Protected Phases	2		1	6	8	1
Permitted Phases		2	6			8
Detector Phase	2	2	1	6	8	1
Switch Phase						
Minimum Initial (s)	20.0	20.0	3.0	20.0	7.0	3.0
Minimum Split (s)	27.0	27.0	10.0	27.0	14.0	10.0
Total Split (s)	52.0	52.0	45.0	97.0	23.0	45.0
Total Split (%)	43.3%	43.3%	37.5%	80.8%	19.2%	37.5%
Maximum Green (s)	45.0	45.0	38.0	90.0	16.0	38.0
Yellow Time (s)	5.0	5.0	5.0	5.0	4.0	5.0
All-Red Time (s)	2.0	2.0	2.0	2.0	3.0	2.0
Lost Time Adjust (s)	-1.0	-1.0	-1.0	-1.0	-1.0	-1.0
Total Lost Time (s)	6.0	6.0	6.0	6.0	6.0	6.0

BT Dreshertown, LP
 3: Dreshertown Road & Welsh Road

2023 With AM Peak (Residential and Office)



Lane Group	EBL	EBR	WBL	WBT	NBL	NBR
Lead/Lag	Lag	Lag	Lead			Lead
Lead-Lag Optimize?						
Vehicle Extension (s)	3.0	3.0	3.0	3.0	3.0	3.0
Recall Mode	C-Max	C-Max	None	C-Max	None	None

Intersection Summary

Area Type: Other
 Cycle Length: 120
 Actuated Cycle Length: 120
 Offset: 85 (71%), Referenced to phase 2:EBT and 6:WBTL, Start of 1st Green
 Natural Cycle: 65
 Control Type: Actuated-Coordinated

Splits and Phases: 3: Dreshertown Road & Welsh Road

p1	p2 (R)	
p5 (R)		p8

	→	↘	↙	←	↖	↗		
Movement	EBT	EBR	WBL	WBT	NBL	NBR		
Lane Configurations	↑↑	↑	↓	↑↑	↓↓	↑		
Volume (veh/h)	1070	655	370	1059	317	327		
Number	2	12	1	6	3	18		
Initial Q (Qb), veh	0	0	0	0	0	0		
Ped-Bike Adj(A_pbT)		1.00	1.00		1.00	1.00		
Parking Bus, Adj	1.00	1.00	1.00	1.00	1.00	1.00		
Adj Sat Flow, veh/h/ln	1800	1836	1739	1739	1722	1808		
Adj Flow Rate, veh/h	1092	624	378	1081	323	251		
Adj No. of Lanes	2	1	1	2	2	1		
Peak Hour Factor	0.98	0.98	0.98	0.98	0.98	0.98		
Percent Heavy Veh, %	1	3	3	3	4	3		
Cap, veh/h	1959	894	444	2505	451	426		
Arrive On Green	1.00	1.00	0.27	1.00	0.14	0.14		
Sat Flow, veh/h	3510	1560	1656	3391	3182	1537		
Grp Volume(v), veh/h	1092	624	378	1081	323	251		
Grp Sat Flow(s),veh/h/ln	1710	1560	1656	1652	1591	1537		
Q Serve(g_s), s	0.0	0.0	11.5	0.0	11.6	16.9		
Cycle Q Clear(g_c), s	0.0	0.0	11.5	0.0	11.6	16.9		
Prop In Lane		1.00	1.00		1.00	1.00		
Lane Grp Cap(c), veh/h	1959	894	444	2505	451	426		
V/C Ratio(X)	0.56	0.70	0.85	0.43	0.72	0.59		
Avail Cap(c_a), veh/h	1959	894	758	2505	451	426		
HCM Platoon Ratio	2.00	2.00	2.00	2.00	1.00	1.00		
Upstream Filter(i)	0.67	0.67	0.81	0.81	0.91	0.91		
Uniform Delay (d), s/veh	0.0	0.0	8.3	0.0	49.2	37.5		
Incr Delay (d2), s/veh	0.8	3.0	3.8	0.4	4.9	1.9		
Initial Q Delay(d3),s/veh	0.0	0.0	0.0	0.0	0.0	0.0		
%ile BackOfQ(95%),veh/ln	0.4	1.4	10.6	0.3	9.1	11.6		
LnGrp Delay(d),s/veh	0.8	3.0	12.2	0.4	54.1	39.4		
LnGrp LOS	A	A	B	A	D	D		
Approach Vol, veh/h	1716			1459	574			
Approach Delay, s/veh	1.6			3.5	47.7			
Approach LOS	A			A	D			
Timer	1	2	3	4	5	6	7	8
Assigned Phs	1	2				6		8
Phs Duration (G+Y+Rc), s	22.3	74.7				97.0		23.0
Change Period (Y+Rc), s	7.0	7.0				7.0		7.0
Max Green Setting (Gmax), s	38.0	45.0				90.0		16.0
Max Q Clear Time (g_c+I1), s	14.0	2.5				2.5		19.4
Green Ext Time (p_c), s	1.3	14.2				15.4		0.0
Intersection Summary								
HCM 2010 Ctrl-Delay			9.4					
HCM 2010 LOS			A					

BT Dreshertown, LP
4: Dryden Road & Welsh Road

2023 With AM Peak (Residential and Office)



Lane Group	EBL	EBT	EBR	WBL	WBT	WBR	NBL	NET	NBR	SBL	SBT	SBR
Lane Configurations	↖	↕	↗	↖	↕	↗	↖	↕	↗	↖	↕	↗
Volume (vph)	1	1209	193	253	1475	1	20	0	87	2	0	0
Ideal Flow (vphpl)	1800	1800	1800	1800	1800	1800	1800	1800	1800	1800	1800	1800
Lane Width (ft)	10	12	14	10	12	12	11	15	15	12	14	14
Grade (%)		-1%			-1%			-1%			0%	
Storage Length (ft)	150		225	175		0	110		0	150		0
Storage Lanes	1		1	1		0	1		0	1		0
Taper Length (ft)	75			75			75			75		
Lane Util. Factor	1.00	0.95	1.00	1.00	0.95	0.95	1.00	1.00	1.00	1.00	1.00	1.00
Frnt			0.850					0.850				
Flt Protected	0.950			0.950			0.950			0.950		
Satd. Flow (prot)	1604	3403	1640	1573	3370	0	1661	1691	0	1710	1920	0
Flt Permitted	0.141			0.199			0.757			0.605		
Satd. Flow (perm)	238	3403	1640	329	3370	0	1324	1691	0	1089	1920	0
Right Turn on Red			Yes			Yes			Yes			Yes
Satd. Flow (RTOR)			208					116				
Link Speed (mph)		45			45			25			25	
Link Distance (ft)		1040			1416			754			960	
Travel Time (s)		15.8			21.5			20.6			26.2	
Peak Hour Factor	0.93	0.93	0.93	0.93	0.93	0.93	0.93	0.93	0.93	0.93	0.93	0.93
Heavy Vehicles (%)	0%	1%	0%	2%	2%	0%	0%	0%	0%	0%	0%	0%
Adj. Flow (vph)	1	1300	208	272	1586	1	22	0	94	2	0	0
Shared Lane Traffic (%)												
Lane Group Flow (vph)	1	1300	208	272	1587	0	22	94	0	2	0	0
Number of Detectors	1	1	1	1	1		1	1		1	1	
Detector Template												
Leading Detector (ft)	5	5	5	5	5		35	35		35	35	
Trailing Detector (ft)	0	0	0	0	0		-5	-5		-5	-5	
Detector 1 Position(ft)	0	0	0	0	0		-5	-5		-5	-5	
Detector 1 Size(ft)	5	5	5	5	5		40	40		40	40	
Detector 1 Type	CI+Ex	CI+Ex	CI+Ex	CI+Ex	CI+Ex		CI+Ex	CI+Ex		CI+Ex	CI+Ex	
Detector 1 Channel												
Detector 1 Extend (s)	0.0	0.0	0.0	0.0	0.0		0.0	0.0		0.0	0.0	
Detector 1 Queue (s)	0.0	0.0	0.0	0.0	0.0		0.0	0.0		0.0	0.0	
Detector 1 Delay (s)	0.0	0.0	0.0	0.0	0.0		0.0	0.0		0.0	0.0	
Turn Type	Perm	NA	Perm	Perm	NA		Perm	NA		Perm		
Protected Phases		2			6			8			4	
Permitted Phases	2		2	6			8		4		4	
Detector Phase	2	2	2	6	6		8	8		4	4	
Switch Phase												
Minimum Initial (s)	21.0	21.0	21.0	21.0	21.0		5.0	5.0		5.0	5.0	
Minimum Split (s)	27.0	27.0	27.0	27.0	27.0		11.0	11.0		11.0	11.0	
Total Split (s)	97.0	97.0	97.0	97.0	97.0		23.0	23.0		23.0	23.0	
Total Split (%)	80.8%	80.8%	80.8%	80.8%	80.8%		19.2%	19.2%		19.2%	19.2%	
Maximum Green (s)	91.0	91.0	91.0	91.0	91.0		17.0	17.0		17.0	17.0	
Yellow Time (s)	4.0	4.0	4.0	4.0	4.0		3.0	3.0		3.0	3.0	
All-Red Time (s)	2.0	2.0	2.0	2.0	2.0		3.0	3.0		3.0	3.0	
Lost Time Adjust (s)	-1.0	-1.0	-1.0	-1.0	-1.0		-1.0	-1.0		-1.0	-1.0	
Total Lost Time (s)	5.0	5.0	5.0	5.0	5.0		5.0	5.0		5.0	5.0	

BT Dreshertown, LP
 4: Dryden Road & Welsh Road

2023 With AM Peak (Residential and Office)



Lane Group	EBL	EBT	EBR	WBL	WBT	WBR	NBL	NBT	NBR	SBL	SBT	SEB
Lead/Lag												
Lead-Lag Optimize?												
Vehicle Extension (s)	3.0	3.0	3.0	3.0	3.0		3.0	3.0		3.0	3.0	
Recall Mode	C-Max	C-Max	C-Max	C-Max	C-Max		None	None		None	None	

Intersection Summary

Area Type: Other
 Cycle Length: 120
 Actuated Cycle Length: 120
 Offset: 62 (52%), Referenced to phase 2:EBTL and 6:WBTL, Start of 1st Green
 Natural Cycle: 90
 Control Type: Actuated-Coordinated

Splits and Phases: 4: Dryden Road & Welsh Road

φ2 (R)	φ4
φ6 (R)	φ8

Movement	EBL	EBT	EBR	WBL	WBT	WBR	NBL	NBT	NBR	SEL	SBT	SBR
Lane Configurations												
Volume (veh/h)	1	1209	193	253	1475	1	20	0	87	2	0	0
Number	5	2	12	1	6	16	3	8	18	7	4	14
Initial Q (Qb), veh	0	0	0	0	0	0	0	0	0	0	0	0
Ped-Bike Adj(A_pbT)	1.00		1.00	1.00		1.00	1.00		1.00	1.00		1.00
Parking Bus, Adj	1.00	1.00	1.00	1.00	1.00	1.00	1.00	1.00	1.00	1.00	1.00	1.00
Adj Sat Flow, veh/h/ln	1809	1791	1881	1774	1774	1809	1809	1881	1881	1800	1872	1872
Adj Flow Rate, veh/h	1	1300	206	272	1586	1	22	0	94	2	0	0
Adj No. of Lanes	1	2	1	1	2	0	1	1	0	1	1	0
Peak Hour Factor	0.93	0.93	0.93	0.93	0.93	0.93	0.93	0.93	0.93	0.93	0.93	0.93
Percent Heavy Veh, %	0	1	0	2	2	2	0	0	0	0	0	0
Cap, veh/h	287	2834	1332	350	2878	2	182	0	134	101	157	0
Arrive On Green	1.00	1.00	1.00	0.83	0.83	0.82	0.08	0.00	0.08	0.08	0.00	0.00
Sat Flow, veh/h	329	3403	1599	348	3456	2	1447	0	1599	1323	1872	0
Grp Volume(v), veh/h	1	1300	206	272	773	814	22	0	94	2	0	0
Grp Sat Flow(s),veh/h/ln	329	1702	1599	348	1685	1773	1447	0	1599	1323	1872	0
Q Serve(g_s), s	0.1	0.0	0.0	71.7	17.0	17.0	1.7	0.0	6.9	0.2	0.0	0.0
Cycle Q Clear(g_c), s	17.1	0.0	0.0	71.7	17.0	17.0	1.7	0.0	6.9	6.6	0.0	0.0
Prop In Lane	1.00		1.00	1.00		0.00	1.00		1.00	1.00		0.00
Lane Grp Cap(c), veh/h	287	2834	1332	350	1403	1476	182	0	134	101	157	0
V/C Ratio(X)	0.00	0.46	0.15	0.78	0.55	0.55	0.12	0.00	0.70	0.02	0.00	0.00
Avail Cap(c_a), veh/h	287	2834	1332	350	1403	1476	277	0	240	188	281	0
HCM Platoon Ratio	2.00	2.00	2.00	1.00	1.00	1.00	1.00	1.00	1.00	1.00	1.00	1.00
Upstream Filter(I)	0.72	0.72	0.72	1.00	1.00	1.00	1.00	0.00	1.00	1.00	0.00	0.00
Uniform Delay (d), s/veh	1.5	0.0	0.0	7.7	3.1	3.1	51.1	0.0	54.0	56.4	0.0	0.0
Incr Delay (d2), s/veh	0.0	0.4	0.2	15.5	1.6	1.5	0.3	0.0	6.4	0.1	0.0	0.0
Initial Q Delay(d3),s/veh	0.0	0.0	0.0	0.0	0.0	0.0	0.0	0.0	0.0	0.0	0.0	0.0
%ile BackOfQ(95%),veh/ln	0.0	0.3	0.1	12.8	13.1	13.6	1.2	0.0	5.9	0.1	0.0	0.0
LnGrp Delay(d),s/veh	1.5	0.4	0.2	23.2	4.7	4.6	51.4	0.0	60.4	56.5	0.0	0.0
LnGrp LOS	A	A	A	C	A	A	D		E	E		
Approach Vol, veh/h		1507			1859			116				2
Approach Delay, s/veh		0.4			7.3			58.7				56.5
Approach LOS		A			A			E				E
Timer	1	2	3	4	5	6	7	8				
Assigned Phs		2		4		6		8				
Phs Duration (G+Y+Rc), s		104.9		15.1		104.9		15.1				
Change Period (Y+Rc), s		6.0		6.0		6.0		6.0				
Max Green Setting (Gmax), s		91.0		17.0		91.0		17.0				
Max Q Clear Time (g_c+1), s		19.6		9.1		74.2		8.9				
Green Ext Time (p_c), s		32.8		0.2		13.3		0.2				
Intersection Summary												
HCM 2010 Ctrl Delay			6.1									
HCM 2010 LOS			A									

BT Dreshertown, LP
5: Dreshertown Road & Dryden Road

2023 With AM Peak (Residential and Office)

	↙	↖	↑	↗	↘	↓
Lane Group	WBL	WBR	NBT	NBR	SBL	SBT
Lane Configurations	↙	↖	↑	↗	↘	↓
Volume (vph)	81	19	626	148	86	940
Ideal Flow (vphpl)	1800	1800	1800	1800	1800	1800
Lane Width (ft)	12	14	12	14	12	12
Grade (%)	0%		1%			0%
Storage Length (ft)	0	200		150	150	
Storage Lanes	1	1		1	1	
Taper Length (ft)	75			75		
Lane Util. Factor	1.00	1.00	1.00	1.00	1.00	1.00
Frt		0.850		0.850		
Fit Protected	0.950				0.950	
Satd. Flow (prot)	1676	1600	1739	1592	1676	1748
Fit Permitted	0.950				0.393	
Satd. Flow (perm)	1676	1600	1739	1592	694	1748
Right Turn on Red		Yes		Yes		
Satd. Flow (RTOR)		19		151		
Link Speed (mph)	25		40			40
Link Distance (ft)	593		426			600
Travel Time (s)	16.2		7.3			10.2
Peak Hour Factor	0.98	0.98	0.98	0.98	0.98	0.98
Heavy Vehicles (%)	2%	2%	3%	2%	2%	3%
Adj. Flow (vph)	83	19	639	151	88	959
Shared Lane Traffic (%)						
Lane Group Flow (vph)	83	19	639	151	88	959
Number of Detectors	1	1	1	1	1	1
Detector Template	Left	Right	Thru	Right	Left	Thru
Leading Detector (ft)	35	35	5	5	35	5
Trailing Detector (ft)	-5	-5	0	0	-5	0
Detector 1 Position(ft)	-5	-5	0	0	-5	0
Detector 1 Size(ft)	40	40	5	5	40	5
Detector 1 Type	CI+Ex	CI+Ex	CI+Ex	CI+Ex	CI+Ex	CI+Ex
Detector 1 Channel						
Detector 1 Extend (s)	0.0	0.0	0.0	0.0	0.0	0.0
Detector 1 Queue (s)	0.0	0.0	0.0	0.0	0.0	0.0
Detector 1 Delay (s)	0.0	0.0	0.0	0.0	0.0	0.0
Turn Type	Prot	Perm	NA	Perm	Perm	NA
Protected Phases	8		2			6
Permitted Phases		8		2	6	
Detector Phase	8	8	2	2	6	6
Switch Phase						
Minimum Initial (s)	12.0	12.0	20.0	20.0	20.0	20.0
Minimum Split (s)	18.0	18.0	26.0	26.0	26.0	26.0
Total Split (s)	22.0	22.0	98.0	98.0	98.0	98.0
Total Split (%)	18.3%	18.3%	81.7%	81.7%	81.7%	81.7%
Maximum Green (s)	16.0	16.0	92.0	92.0	92.0	92.0
Yellow Time (s)	4.0	4.0	4.0	4.0	4.0	4.0
All-Red Time (s)	2.0	2.0	2.0	2.0	2.0	2.0
Lost Time Adjust (s)	-1.0	-1.0	-1.0	-1.0	-1.0	-1.0
Total Lost Time (s)	5.0	5.0	5.0	5.0	5.0	5.0

BT Dreshertown, LP
 5: Dreshertown Road & Dryden Road

2023 With AM Peak (Residential and Office)



Lane Group	WBL	WBR	NBT	NBR	SBL	SBT
Lead/Lag						
Lead-Lag Optimize?						
Vehicle Extension (s)	3.0	3.0	3.0	3.0	3.0	3.0
Recall Mode	None	None	C-Max	C-Max	C-Max	C-Max

Intersection Summary

Area Type: Other
 Cycle Length: 120
 Actuated Cycle Length: 120
 Offset: 116 (97%), Referenced to phase 2:NBT and 6:SBTL, Start of 1st Green
 Natural Cycle: 60
 Control Type: Actuated-Coordinated

Splits and Phases: 5: Dreshertown Road & Dryden Road

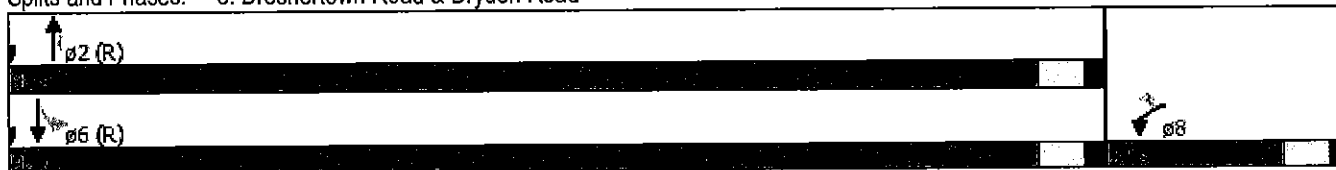



Movement	WBL	WBR	NBT	NBR	SBL	SBT
Lane Configurations	↖	↗	↑	↓	↖	↗
Volume (veh/h)	81	19	626	148	86	940
Number	3	18	2	12	1	6
Initial Q (Qb), veh	0	0	0	0	0	0
Ped-Bike Adj(A_pbT)	1.00	1.00		1.00	1.00	
Parking Bus, Adj	1.00	1.00	1.00	1.00	1.00	1.00
Adj Sat Flow, veh/h/ln	1765	1835	1739	1826	1765	1748
Adj Flow Rate, veh/h	83	19	639	151	88	959
Adj No. of Lanes	1	1	1	1	1	1
Peak Hour Factor	0.98	0.98	0.98	0.98	0.98	0.98
Percent Heavy Veh, %	2	2	3	2	2	3
Cap, veh/h	176	164	1411	1260	540	1418
Arrive On Green	0.10	0.10	0.81	0.81	0.81	0.81
Sat Flow, veh/h	1681	1560	1739	1552	683	1748
Grp Volume(v), veh/h	83	19	639	151	88	959
Grp Sat Flow(s),veh/h/ln	1681	1560	1739	1552	683	1748
Q Serve(g_s), s	5.6	1.3	13.1	2.4	5.3	27.5
Cycle Q Clear(g_c), s	5.6	1.3	13.1	2.4	18.4	27.5
Prop In Lane	1.00	1.00		1.00	1.00	
Lane Grp Cap(c), veh/h	176	164	1411	1260	540	1418
V/C Ratio(X)	0.47	0.12	0.45	0.12	0.16	0.68
Avail Cap(c_a), veh/h	238	221	1411	1260	540	1418
HCM Platoon Ratio	1.00	1.00	1.00	1.00	1.00	1.00
Upstream Filter(I)	1.00	1.00	1.00	1.00	0.64	0.64
Uniform Delay (d), s/veh	50.6	48.7	3.4	2.4	6.1	4.7
Incr Delay (d2), s/veh	1.9	0.3	1.1	0.2	0.4	1.7
Initial Q Delay(d3),s/veh	0.0	0.0	0.0	0.0	0.0	0.0
%ile BackOfQ(95%),veh/ln	4.9	1.1	10.8	1.9	1.9	18.2
LnGrp Delay(d),s/veh	52.5	49.0	4.4	2.6	6.5	6.4
LnGrp LOS	D	D	A	A	A	A
Approach Vol, veh/h	102		790			1047
Approach Delay, s/veh	51.8		4.1			6.4
Approach LOS	D		A			A

Timer	1	2	3	4	5	6	7	8
Assigned Phs		2				6		8
Phs Duration (G+Y+Rc), s		102.4				102.4		17.6
Change Period (Y+Rc), s		6.0				6.0		6.0
Max Green Setting (Gmax), s		92.0				92.0		16.0
Max Q Clear Time (g_c+I1), s		15.6				30.0		8.1
Green Ext Time (p_c), s		7.5				7.5		0.2

Intersection Summary	
HCM 2010 Ctrl Delay	7.8
HCM 2010 LOS	A

1: Jarretstown Road/Village Road & Welsh Road



Lane Group	EBL	EBT	EBR	WBL	WBT	WBR	NBL	NBT	NBR	SBL	SBT	SBR
Lane Configurations	↖	↕		↖	↕		↖	↕	↗		↕	
Volume (vph)	22	837	30	285	1074	15	22	21	274	42	94	108
Ideal Flow (vphpl)	1800	1800	1800	1800	1800	1800	1800	1800	1800	1800	1800	1800
Lane Width (ft)	12	12	12	11	14	14	12	12	14	15	15	15
Grade (%)		-6%			1%			-1%			1%	
Storage Length (ft)	150		0	100		0	0		175	0		0
Storage Lanes	1		0	1		0	0		1	0		0
Taper Length (ft)	75			75			75			75		
Lane Util. Factor	1.00	0.95	0.95	1.00	1.00	1.00	1.00	1.00	1.00	1.00	1.00	1.00
Friction		0.995			0.998				0.850		0.940	
Fit Protected	0.950			0.950				0.975			0.991	
Satd. Flow (prot)	1761	3471	0	1645	1907	0	0	1764	1640	0	1826	0
Fit Permitted	0.149			0.233				0.642			0.935	
Satd. Flow (perm)	276	3471	0	403	1907	0	0	1161	1640	0	1723	0
Right Turn on Red			Yes			Yes			Yes			Yes
Satd. Flow (RTOR)		4			1				87		31	
Link Speed (mph)		45			45			35			35	
Link Distance (ft)		1263			605			421			431	
Travel Time (s)		19.1			9.2			8.2			8.4	
Peak Hour Factor	0.96	0.96	0.96	0.96	0.96	0.96	0.96	0.96	0.96	0.96	0.96	0.96
Heavy Vehicles (%)	0%	1%	0%	0%	0%	0%	0%	0%	0%	3%	0%	0%
Adj. Flow (vph)	23	872	31	297	1119	16	23	22	285	44	98	112
Shared Lane Traffic (%)												
Lane Group Flow (vph)	23	903	0	297	1135	0	0	45	285	0	254	0
Number of Detectors	1	2		1	2		1	1	1	1	1	
Detector Template	Left			Left			Left	Thru	Right	Left	Thru	
Leading Detector (ft)	5	330		35	330		20	35	35	20	35	
Trailing Detector (ft)	0	0		-5	0		0	-5	-5	0	-5	
Detector 1 Position(ft)	0	0		-5	0		0	-5	-5	0	-5	
Detector 1 Size(ft)	5	6		40	6		20	40	40	20	40	
Detector 1 Type	CI+Ex	CI+Ex		CI+Ex	CI+Ex		CI+Ex	CI+Ex	CI+Ex	CI+Ex	CI+Ex	
Detector 1 Channel												
Detector 1 Extend (s)	0.0	0.0		0.0	0.0		0.0	0.0	0.0	0.0	0.0	
Detector 1 Queue (s)	0.0	0.0		0.0	0.0		0.0	0.0	0.0	0.0	0.0	
Detector 1 Delay (s)	0.0	0.0		0.0	0.0		0.0	0.0	0.0	0.0	0.0	
Detector 2 Position(ft)		324			324							
Detector 2 Size(ft)		6			6							
Detector 2 Type		CI+Ex			CI+Ex							
Detector 2 Channel												
Detector 2 Extend (s)		0.0			0.0							
Turn Type	Perm	NA		pm+pt	NA		Perm	NA	pm+ov	Perm	NA	
Protected Phases		2		1	6			8	1		4	
Permitted Phases	2			6			8		8	4		
Detector Phase	2	2		1	6		8	8	1	4	4	
Switch Phase												
Minimum Initial (s)	15.0	15.0		3.0	15.0		7.0	7.0	3.0	7.0	7.0	
Minimum Split (s)	22.0	22.0		10.0	22.0		13.0	13.0	10.0	13.0	13.0	
Total Split (s)	61.0	61.0		26.0	87.0		33.0	33.0	26.0	33.0	33.0	
Total Split (%)	50.8%	50.8%		21.7%	72.5%		27.5%	27.5%	21.7%	27.5%	27.5%	

1: Jarretstown Road/Village Road & Welsh Road



Lane Group	EBL	EBT	EBR	WBI	WBT	WBR	NBI	NBT	NBR	SBL	SBT	GBR
Maximum Green (s)	54.0	54.0		19.0	80.0		27.0	27.0	19.0	27.0	27.0	
Yellow Time (s)	5.0	5.0		5.0	5.0		4.0	4.0	5.0	4.0	4.0	
All-Red Time (s)	2.0	2.0		2.0	2.0		2.0	2.0	2.0	2.0	2.0	
Lost Time Adjust (s)	-1.0	-1.0		-1.0	-1.0			-1.0	-1.0		-1.0	
Total Lost Time (s)	6.0	6.0		6.0	6.0		5.0	5.0	6.0	6.0	5.0	
Lead/Lag	Lag	Lag		Lead					Lead			
Lead-Lag Optimize?												
Vehicle Extension (s)	3.0	3.0		3.0	3.0		3.0	3.0	3.0	3.0	3.0	
Recall Mode	C-Max	C-Max		None	C-Max		None	None	None	None	None	

Intersection Summary

Area Type: Other
 Cycle Length: 120
 Actuated Cycle Length: 120
 Offset: 5 (4%), Referenced to phase 2:EBTL and 6:WBTL, Start of 1st Green
 Natural Cycle: 60
 Control Type: Actuated-Coordinated

Splits and Phases: 1: Jarretstown Road/Village Road & Welsh Road



1: Jarretstown Road/Village Road & Welsh Road

Movement	EBL	EBT	EBR	WBL	WBT	WBR	NBL	NBT	NBR	SBL	SBT	SBR
Lane Configurations	↖	↕	↗	↖	↕	↗	↖	↕	↗	↖	↕	↗
Volume (veh/h)	22	837	30	285	1074	15	22	21	274	42	94	108
Number	5	2	12	1	6	16	3	8	18	7	4	14
Initial Q (Qb), veh	0	0	0	0	0	0	0	0	0	0	0	0
Ped-Bike Adj(A_pbT)	1.00		1.00	1.00		1.00	1.00		1.00	1.00		1.00
Parking Bus, Adj	1.00	1.00	1.00	1.00	1.00	1.00	1.00	1.00	1.00	1.00	1.00	1.00
Adj Sat Flow, veh/h/ln	1854	1836	1854	1791	1863	1863	1809	1809	1881	1863	1853	1863
Adj Flow Rate, veh/h	23	872	30	297	1119	15	23	22	264	44	98	98
Adj No. of Lanes	1	2	0	1	1	0	0	1	1	0	1	0
Peak Hour Factor	0.96	0.96	0.96	0.96	0.96	0.96	0.96	0.96	0.96	0.96	0.96	0.96
Percent Heavy Veh, %	0	1	1	0	0	0	0	0	0	0	0	0
Cap, veh/h	216	1986	68	499	1331	18	128	109	450	75	133	119
Arrive On Green	0.58	0.58	0.57	0.10	0.73	0.72	0.17	0.18	0.18	0.17	0.18	0.17
Sat Flow, veh/h	519	3441	118	1706	1834	25	450	596	1599	218	730	654
Grp Volume(v), veh/h	23	442	460	297	0	1134	45	0	264	240	0	0
Grp Sat Flow(s),veh/h/ln	519	1744	1815	1706	0	1858	1046	0	1599	1602	0	0
Q Serve(g_s), s	3.9	17.2	17.2	7.7	0.0	51.5	0.0	0.0	17.1	12.3	0.0	0.0
Cycle Q Clear(g_c), s	37.1	17.2	17.2	7.7	0.0	51.5	3.2	0.0	17.1	17.3	0.0	0.0
Prop In Lane	1.00		0.07	1.00		0.01	0.51		1.00	0.18		0.41
Lane Grp Cap(c), veh/h	216	1007	1048	499	0	1349	228	0	450	315	0	0
V/C Ratio(X)	0.11	0.44	0.44	0.60	0.00	0.84	0.20	0.00	0.59	0.76	0.00	0.00
Avail Cap(c_a), veh/h	216	1007	1048	615	0	1349	301	0	531	394	0	0
HCM Platoon Ratio	1.00	1.00	1.00	1.00	1.00	1.00	1.00	1.00	1.00	1.00	1.00	1.00
Upstream Filter(I)	1.00	1.00	1.00	1.00	0.00	1.00	1.00	0.00	1.00	1.00	0.00	0.00
Uniform Delay (d), s/veh	30.7	14.4	14.4	9.8	0.0	11.6	41.4	0.0	37.1	47.3	0.0	0.0
Incr Delay (d2), s/veh	1.0	1.4	1.3	1.1	0.0	6.5	0.4	0.0	1.2	6.7	0.0	0.0
Initial Q Delay(d3),s/veh	0.0	0.0	0.0	0.0	0.0	0.0	0.0	0.0	0.0	0.0	0.0	0.0
%ile BackOfQ(95%),veh/ln	1.1	13.4	13.9	6.7	0.0	37.3	2.4	0.0	12.2	13.1	0.0	0.0
LnGrp Delay(d),s/veh	31.7	15.8	15.7	10.9	0.0	18.1	41.8	0.0	38.4	54.0	0.0	0.0
LnGrp LOS	C	B	B	B		B	D		D	D		
Approach Vol, veh/h		925			1431			309			240	
Approach Delay, s/veh		16.1			16.6			38.9			54.0	
Approach LOS		B			B			D			D	
Timer	1	2	3	4	5	6	7	8				
Assigned Phs	1	2		4		6		8				
Phs Duration (G+Y+Rc), s	17.8	75.3		26.9		93.1		26.9				
Change Period (Y+Rc), s	7.0	7.0		6.0		7.0		6.0				
Max Green Setting (Gmax), s	19.0	54.0		27.0		80.0		27.0				
Max Q Clear Time (g_c+I1), s	10.2	39.6		19.3		53.5		19.6				
Green Ext Time (p_c), s	0.6	14.1		1.4		25.7		1.4				
Intersection Summary												
HCM 2010 Ctrl Delay			21.9									
HCM 2010 LOS			C									

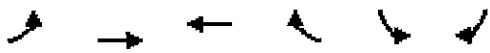

Lane Group	EBL	EBT	WBT	WBR	SBL	SBR
Lane Configurations	↵	↕↕	↕↕	↗	↗↗	↗
Volume (vph)	315	895	1013	663	906	426
Ideal Flow (vphpl)	1800	1800	1800	1800	1800	1800
Lane Width (ft)	10	11	11	11	12	13
Grade (%)		-1%	1%		1%	
Storage Length (ft)	225			210	0	415
Storage Lanes	1			1	2	1
Taper Length (ft)	75				75	
Lane Util. Factor	1.00	0.95	0.95	1.00	0.97	1.00
Frt				0.850		0.850
Flt Protected	0.950				0.950	
Satd. Flow (prot)	1588	3257	3257	1457	3268	1558
Flt Permitted	0.084				0.950	
Satd. Flow (perm)	140	3257	3257	1457	3268	1558
Right Turn on Red				Yes		Yes
Satd. Flow (RTOR)				180		15
Link Speed (mph)		45	45		35	
Link Distance (ft)		475	550		970	
Travel Time (s)		7.2	8.3		18.9	
Peak Hour Factor	0.95	0.95	0.95	0.95	0.95	0.95
Heavy Vehicles (%)	1%	2%	1%	1%	1%	1%
Adj. Flow (vph)	332	942	1066	698	954	448
Shared Lane Traffic (%)						
Lane Group Flow (vph)	332	942	1066	698	954	448
Number of Detectors	1	1	1	1	1	1
Detector Template						
Leading Detector (ft)	35	5	5	5	35	35
Trailing Detector (ft)	-5	0	0	0	-5	-5
Detector 1 Position(ft)	-5	0	0	0	-5	-5
Detector 1 Size(ft)	40	5	5	5	40	40
Detector 1 Type	CI+Ex	CI+Ex	CI+Ex	CI+Ex	CI+Ex	CI+Ex
Detector 1 Channel						
Detector 1 Extend (s)	0.0	0.0	0.0	0.0	0.0	0.0
Detector 1 Queue (s)	0.0	0.0	0.0	0.0	0.0	0.0
Detector 1 Delay (s)	0.0	0.0	0.0	0.0	0.0	0.0
Turn Type	pm+pt	NA	NA	pm+ov	Prot	pm+ov
Protected Phases	5	2	6	4	4	5
Permitted Phases	2			6		4
Detector Phase	5	2	6	4	4	5
Switch Phase						
Minimum Initial (s)	3.0	20.0	20.0	7.0	7.0	3.0
Minimum Split (s)	9.0	26.0	26.0	14.0	14.0	9.0
Total Split (s)	30.0	76.0	46.0	44.0	44.0	30.0
Total Split (%)	25.0%	63.3%	38.3%	36.7%	36.7%	25.0%
Maximum Green (s)	24.0	70.0	40.0	37.0	37.0	24.0
Yellow Time (s)	4.0	4.0	4.0	4.0	4.0	4.0
All-Red Time (s)	2.0	2.0	2.0	3.0	3.0	2.0
Lost Time Adjust (s)	-1.0	-1.0	-1.0	-1.0	-1.0	-1.0
Total Lost Time (s)	5.0	5.0	5.0	6.0	6.0	5.0



Lane Group	EBL	EBT	WBT	WBR	SEB	SBR
Lead/Lag	Lead		Lag		Lead	
Lead-Lag Optimize?						
Vehicle Extension (s)	3.0	3.0	3.0	3.0	3.0	3.0
Recall Mode	None	C-Max	C-Max	None	None	None
Act Effct Green (s)	71.2	71.2	42.5	85.4	37.8	67.5
Actuated g/C Ratio	0.59	0.59	0.35	0.71	0.32	0.56
v/c Ratio	0.90	0.49	0.92	0.64	0.93	0.51
Control Delay	56.4	22.8	45.9	7.4	55.3	17.6
Queue Delay	0.0	0.1	0.7	0.4	0.0	0.2
Total Delay	56.4	23.0	46.6	7.8	55.3	17.8
LOS	E	C	D	A	E	B
Approach Delay		31.7	31.3		43.3	
Approach LOS		C	C		D	
Queue Length 50th (ft)	214	298	346	162	367	189
Queue Length 95th (ft)	#370	370	m#527	m216	#491	276
Internal Link Dist (ft)		395	470		890	
Turn Bay Length (ft)	225			210		415
Base Capacity (vph)	384	1932	1154	1089	1034	900
Starvation Cap Reductn	0	0	13	99	0	0
Spillback Cap Reductn	0	258	0	0	0	76
Storage Cap Reductn	0	0	0	0	0	0
Reduced v/c Ratio	0.86	0.56	0.93	0.71	0.92	0.54

Intersection Summary

Area Type: Other
 Cycle Length: 120
 Actuated Cycle Length: 120
 Offset: 77 (64%), Referenced to phase 2:EBTL and 6:WBT, Start of 1st Green
 Natural Cycle: 80
 Control Type: Actuated-Coordinated
 Maximum v/c Ratio: 0.93
 Intersection Signal Delay: 35.2
 Intersection LOS: D
 Intersection Capacity Utilization 88.6%
 ICU Level of Service E
 Analysis Period (min) 15
 # 95th percentile volume exceeds capacity, queue may be longer.
 Queue shown is maximum after two cycles.
 m Volume for 95th percentile queue is metered by upstream signal.

Splits and Phases: 2: Welsh Road & Dresher Road



BT Dreshertown, LP
3: Dreshertown Road & Welsh Road

2023 With PM Peak (Residential and Office)



Lane Group	EBI	EBR	WEL	WBT	NBI	NBR
Lane Configurations	↑↑	↑	↑	↑↑	↑↑	↑
Volume (vph)	1183	618	401	1174	501	400
Ideal Flow (vphpl)	1800	1800	1800	1800	1800	1800
Lane Width (ft)	11	15	10	12	12	15
Grade (%)	-2%			1%	1%	
Storage Length (ft)		150	175		0	350
Storage Lanes		1	1		2	2
Taper Length (ft)			75		75	
Lane Util. Factor	0.95	1.00	1.00	0.95	0.97	1.00
Frt		0.850				0.850
Flt Protected			0.950		0.950	
Satd. Flow (prot)	3274	1683	1557	3369	3268	1626
Flt Permitted			0.071		0.950	
Satd. Flow (perm)	3274	1683	116	3369	3268	1626
Right Turn on Red		Yes				Yes
Satd. Flow (RTOR)		338				13
Link Speed (mph)	45			45	40	
Link Distance (ft)	550			1040	600	
Travel Time (s)	8.3			15.8	10.2	
Peak Hour Factor	0.96	0.96	0.96	0.96	0.96	0.96
Heavy Vehicles (%)	2%	1%	2%	1%	1%	3%
Adj. Flow (vph)	1232	644	418	1223	522	417
Shared Lane Traffic (%)						
Lane Group Flow (vph)	1232	644	418	1223	522	417
Number of Detectors	1	1	1	1	1	1
Detector Template						
Leading Detector (ft)	5	5	35	5	35	35
Trailing Detector (ft)	0	0	-5	0	-5	-5
Detector 1 Position(ft)	0	0	-5	0	-5	-5
Detector 1 Size(ft)	5	5	40	5	40	40
Detector 1 Type	CI+Ex	CI+Ex	CI+Ex	CI+Ex	CI+Ex	CI+Ex
Detector 1 Channel						
Detector 1 Extend (s)	0.0	0.0	0.0	0.0	0.0	0.0
Detector 1 Queue (s)	0.0	0.0	0.0	0.0	0.0	0.0
Detector 1 Delay (s)	0.0	0.0	0.0	0.0	0.0	0.0
Turn Type	NA	Perm	pm+pt	NA	Prot	pm+ov
Protected Phases	2		1	6	8	1
Permitted Phases		2	6			8
Detector Phase	2	2	1	6	8	1
Switch Phase						
Minimum Initial (s)	20.0	20.0	3.0	20.0	7.0	3.0
Minimum Split (s)	27.0	27.0	10.0	27.0	14.0	10.0
Total Split (s)	52.0	52.0	42.0	94.0	26.0	42.0
Total Split (%)	43.3%	43.3%	35.0%	78.3%	21.7%	35.0%
Maximum Green (s)	45.0	45.0	35.0	87.0	19.0	35.0
Yellow Time (s)	5.0	5.0	5.0	5.0	4.0	5.0
All-Red Time (s)	2.0	2.0	2.0	2.0	3.0	2.0
Lost Time Adjust (s)	-1.0	-1.0	-1.0	-1.0	-1.0	-1.0
Total Lost Time (s)	6.0	6.0	6.0	6.0	6.0	6.0

BT Dreshertown, LP
 3: Dreshertown Road & Welsh Road

2023 With PM Peak (Residential and Office)



Lane Group	EBT	EBR	WBL	WBT	NBL	NBR
Lead/Lag	Lag	Lag	Lead			Lead
Lead-Lag Optimize?						
Vehicle Extension (s)	3.0	3.0	3.0	3.0	3.0	3.0
Recall Mode	C-Max	C-Max	None	C-Max	None	None

Intersection Summary

Area Type: Other
 Cycle Length: 120
 Actuated Cycle Length: 120
 Offset: 29 (24%), Referenced to phase 2:EBT and 6:WBTL, Start of 1st Green
 Natural Cycle: 90
 Control Type: Actuated-Coordinated

Splits and Phases: 3: Dreshertown Road & Welsh Road

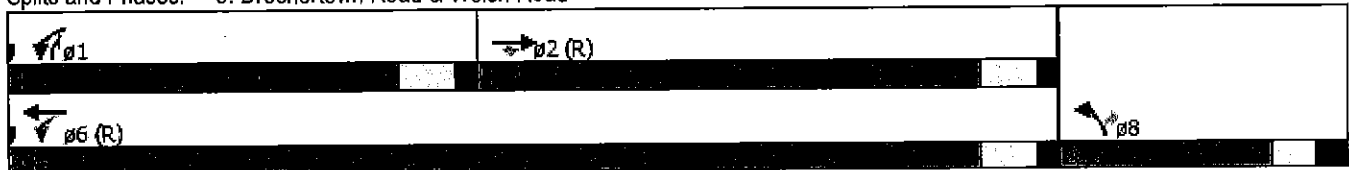



Movement	FBT	EBR	WBL	WBT	NBL	NBR
Lane Configurations	↑↑	↑	↑	↑↑	↑↑	↑
Volume (veh/h)	1183	618	401	1174	501	400
Number	2	12	1	6	3	18
Initial Q (Qb), veh	0	0	0	0	0	0
Ped-Bike Adj(A_pbT)		1.00	1.00		1.00	1.00
Parking Bus, Adj	1.00	1.00	1.00	1.00	1.00	1.00
Adj Sat Flow, veh/h/ln	1782	1872	1756	1773	1773	1808
Adj Flow Rate, veh/h	1232	618	418	1223	522	371
Adj No. of Lanes	2	1	1	2	2	1
Peak Hour Factor	0.96	0.96	0.96	0.96	0.96	0.96
Percent Heavy Veh, %	2	1	2	1	1	3
Cap, veh/h	1611	757	451	2471	546	575
Arrive On Green	0.48	0.48	0.42	1.00	0.17	0.17
Sat Flow, veh/h	3476	1591	1672	3458	3276	1537
Grp Volume(v), veh/h	1232	618	418	1223	522	371
Grp Sat Flow(s), veh/h/ln	1693	1591	1672	1685	1638	1537
Q Serve(g_s), s	36.0	39.9	20.2	0.0	19.0	20.0
Cycle Q Clear(g_c), s	36.0	39.9	20.2	0.0	19.0	20.0
Prop In Lane		1.00	1.00		1.00	1.00
Lane Grp Cap(c), veh/h	1611	757	451	2471	546	575
V/C Ratio(X)	0.76	0.82	0.93	0.49	0.96	0.64
Avail Cap(c_a), veh/h	1611	757	605	2471	546	575
HCM Platoon Ratio	1.00	1.00	2.00	2.00	1.00	1.00
Upstream Filter(I)	0.64	0.64	0.77	0.77	0.76	0.76
Uniform Delay (d), s/veh	25.9	27.0	21.3	0.0	49.6	31.0
Incr Delay (d2), s/veh	2.3	6.3	14.2	0.6	23.3	1.9
Initial Q Delay(d3),s/veh	0.0	0.0	0.0	0.0	0.0	0.0
%ile BackOfQ(95%),veh/ln	22.7	24.5	19.8	0.3	14.9	15.0
LnGrp Delay(d),s/veh	28.2	33.2	35.5	0.6	72.9	32.9
LnGrp LOS	C	C	D	A	E	C
Approach Vol, veh/h	1850			1641	893	
Approach Delay, s/veh	29.9			9.5	56.3	
Approach LOS	C			A	E	

Phaser	1	2	3	4	5	6	7	8
Assigned Phs	1	2				6		8
Phs Duration (G+Y+Rc), s	30.9	63.1				94.0		26.0
Change Period (Y+Rc), s	7.0	7.0				7.0		7.0
Max Green Setting (Gmax), s	35.0	45.0				87.0		19.0
Max Q Clear Time (g_c+I1), s	22.7	41.9				2.5		22.5
Green Ext Time (p_c), s	1.2	2.6				19.2		0.0

Intersection Summary	
HCM 2010 Ctrl Delay	27.6
HCM 2010 LOS	C

BT Dreshertown, LP
4: Dryden Road & Welsh Road

2023 With PM Peak (Residential and Office)

Lane Group	EBL	EBT	EBR	WBL	WBT	WBR	NBL	NET	NBR	SBL	SBT	SBR
Lane Configurations												
Volume (vph)	0	1594	27	104	1392	0	176	8	193	3	0	1
Ideal Flow (vphpl)	1800	1800	1800	1800	1800	1800	1800	1800	1800	1800	1800	1800
Lane Width (ft)	10	12	14	10	12	12	11	15	15	12	14	14
Grade (%)		-1%			-1%			-1%			0%	
Storage Length (ft)	150		225	175		0	110		0	150		0
Storage Lanes	1		1	1		0	1		0	1		0
Taper Length (ft)	75			75			75			75		
Lane Util. Factor	1.00	0.95	1.00	1.00	0.95	0.95	1.00	1.00	1.00	1.00	1.00	1.00
Frt			0.850					0.856			0.850	
Flt Protected				0.950			0.950			0.950		
Satd. Flow (prot)	1688	3403	1640	1604	3370	0	1661	1703	0	1710	1632	0
Flt Permitted				0.114			0.757			0.363		
Satd. Flow (perm)	1688	3403	1640	192	3370	0	1324	1703	0	653	1632	0
Right Turn on Red			Yes			Yes			Yes			Yes
Satd. Flow (RTOR)			28					58			86	
Link Speed (mph)		45			45			25			25	
Link Distance (ft)		1040			1416			754			960	
Travel Time (s)		15.8			21.5			20.6			26.2	
Peak Hour Factor	0.97	0.97	0.97	0.97	0.97	0.97	0.97	0.97	0.97	0.97	0.97	0.97
Heavy Vehicles (%)	0%	1%	0%	0%	2%	0%	0%	0%	0%	0%	0%	0%
Adj. Flow (vph)	0	1643	28	107	1435	0	181	8	199	3	0	1
Shared Lane Traffic (%)												
Lane Group Flow (vph)	0	1643	28	107	1435	0	181	207	0	3	1	0
Number of Detectors	1	1	1	1	1		1	1		1	1	
Detector Template												
Leading Detector (ft)	5	5	5	5	5		35	35		35	35	
Trailing Detector (ft)	0	0	0	0	0		-5	-5		-5	-5	
Detector 1 Position(ft)	0	0	0	0	0		-5	-5		-5	-5	
Detector 1 Size(ft)	5	5	5	5	5		40	40		40	40	
Detector 1 Type	CI+Ex	CI+Ex	CI+Ex	CI+Ex	CI+Ex		CI+Ex	CI+Ex		CI+Ex	CI+Ex	
Detector 1 Channel												
Detector 1 Extend (s)	0.0	0.0	0.0	0.0	0.0		0.0	0.0		0.0	0.0	
Detector 1 Queue (s)	0.0	0.0	0.0	0.0	0.0		0.0	0.0		0.0	0.0	
Detector 1 Delay (s)	0.0	0.0	0.0	0.0	0.0		0.0	0.0		0.0	0.0	
Turn Type	Perm	NA	Perm	Perm	NA		Perm	NA		Perm	NA	
Protected Phases		2			6			8			4	
Permitted Phases	2		2	6			8			4		
Detector Phase	2	2	2	6	6		8	8		4	4	
Switch Phase												
Minimum Initial (s)	21.0	21.0	21.0	21.0	21.0		5.0	5.0		5.0	5.0	
Minimum Split (s)	27.0	27.0	27.0	27.0	27.0		11.0	11.0		11.0	11.0	
Total Split (s)	95.0	95.0	95.0	95.0	95.0		25.0	25.0		25.0	25.0	
Total Split (%)	79.2%	79.2%	79.2%	79.2%	79.2%		20.8%	20.8%		20.8%	20.8%	
Maximum Green (s)	89.0	89.0	89.0	89.0	89.0		19.0	19.0		19.0	19.0	
Yellow Time (s)	4.0	4.0	4.0	4.0	4.0		3.0	3.0		3.0	3.0	
All-Red Time (s)	2.0	2.0	2.0	2.0	2.0		3.0	3.0		3.0	3.0	
Lost Time Adjust (s)	-1.0	-1.0	-1.0	-1.0	-1.0		-1.0	-1.0		-1.0	-1.0	
Total Lost Time (s)	5.0	5.0	5.0	5.0	5.0		5.0	5.0		5.0	5.0	

BT Dreshertown, LP
 4: Dryden Road & Welsh Road

2023 With PM Peak (Residential and Office)



Lane Group	EBL	EBT	EBR	WBL	WBT	WBR	NBL	NBT	NBR	SBL	SBT	SBR
Lead/Lag												
Lead-Lag Optimize?												
Vehicle Extension (s)	3.0	3.0	3.0	3.0	3.0		3.0	3.0		3.0	3.0	
Recall Mode	C-Max	C-Max	C-Max	C-Max	C-Max		None	None		None	None	

Intersection Summary

Area Type: Other
 Cycle Length: 120
 Actuated Cycle Length: 120
 Offset: 59 (49%), Referenced to phase 2:EBTL and 6:WBTL, Start of 1st Green
 Natural Cycle: 80
 Control Type: Actuated-Coordinated

Splits and Phases: 4: Dryden Road & Welsh Road

p2 (R)	p4
p6 (R)	p8

Movement	EBL	EBI	EBR	WBL	WBT	WBR	NBL	NBT	NBR	SBL	SBT	SBR
Lane Configurations	↖	↕	↗	↖	↕	↗	↖	↕	↗	↖	↕	↗
Volume (veh/h)	0	1594	27	104	1392	0	176	8	193	3	0	1
Number	5	2	12	1	6	16	3	8	18	7	4	14
Initial Q (Qb), veh	0	0	0	0	0	0	0	0	0	0	0	0
Ped-Bike Adj(A_pbT)	1.00		1.00	1.00		1.00	1.00		1.00	1.00		1.00
Parking Bus, Adj	1.00	1.00	1.00	1.00	1.00	1.00	1.00	1.00	1.00	1.00	1.00	1.00
Adj Sat Flow, veh/h/ln	1809	1791	1881	1809	1774	1809	1809	1881	1881	1800	1872	1872
Adj Flow Rate, veh/h	0	1643	26	107	1435	0	181	8	199	3	0	1
Adj No. of Lanes	1	2	1	1	2	0	1	1	0	1	1	0
Peak Hour Factor	0.97	0.97	0.97	0.97	0.97	0.97	0.97	0.97	0.97	0.97	0.97	0.97
Percent Heavy Veh, %	0	1	0	0	2	2	0	0	0	0	0	0
Cap, veh/h	60	2593	1218	291	2567	0	284	10	239	101	0	246
Arrive On Green	0.00	1.00	1.00	0.76	0.76	0.00	0.15	0.15	0.15	0.15	0.00	0.15
Sat Flow, veh/h	380	3403	1599	303	3458	0	1446	62	1546	1194	0	1591
Grp Volume(v), veh/h	0	1643	26	107	1435	0	181	0	207	3	0	1
Grp Sat Flow(s),veh/h/ln	380	1702	1599	303	1685	0	1446	0	1608	1194	0	1591
Q Serve(g_s), s	0.0	0.0	0.0	15.6	21.2	0.0	14.5	0.0	15.0	0.3	0.0	0.1
Cycle Q Clear(g_c), s	0.0	0.0	0.0	15.6	21.2	0.0	14.5	0.0	15.0	14.8	0.0	0.1
Prop In Lane	1.00		1.00	1.00		0.00	1.00		0.96	1.00		1.00
Lane Grp Cap(c), veh/h	60	2593	1218	291	2567	0	284	0	249	101	0	246
V/C Ratio(X)	0.00	0.63	0.02	0.37	0.56	0.00	0.64	0.00	0.83	0.03	0.00	0.00
Avail Cap(c_a), veh/h	60	2593	1218	291	2567	0	301	0	268	115	0	265
HCM Platoon Ratio	2.00	2.00	2.00	1.00	1.00	1.00	1.00	1.00	1.00	1.00	1.00	1.00
Upstream Filter(I)	0.00	0.49	0.49	1.00	1.00	0.00	1.00	0.00	1.00	1.00	0.00	1.00
Uniform Delay (d), s/veh	0.0	0.0	0.0	5.3	5.9	0.0	49.0	0.0	49.7	56.1	0.0	43.3
Incr Delay (d2), s/veh	0.0	0.6	0.0	3.5	0.9	0.0	4.1	0.0	18.4	0.1	0.0	0.0
Initial Q Delay(d3),s/veh	0.0	0.0	0.0	0.0	0.0	0.0	0.0	0.0	0.0	0.0	0.0	0.0
%ile BackOfQ(95%),veh/ln	0.0	0.4	0.0	2.8	15.3	0.0	10.2	0.0	12.6	0.2	0.0	0.1
LnGrp Delay(d),s/veh	0.0	0.6	0.0	8.8	6.8	0.0	53.1	0.0	68.1	56.3	0.0	43.3
LnGrp LOS		A	A	A	A		D		E	E		D
Approach Vol, veh/h		1669			1542			388				4
Approach Delay, s/veh		0.6			7.0			61.1				53.0
Approach LOS		A			A			E				D
Timer	1	2	3	4	5	6	7	8				
Assigned Phs		2		4		6		8				
Phs Duration (G+Y+Rc), s		96.4		23.6		96.4		23.6				
Change Period (Y+Rc), s		6.0		6.0		6.0		6.0				
Max Green Setting (Gmax), s		89.0		19.0		89.0		19.0				
Max Q Clear Time (g_c+I1), s		2.5		17.3		23.7		17.0				
Green Ext Time (p_c), s		29.1		0.3		27.1		0.3				
Intersection Summary												
HCM 2010 Ctrl Delay			9.9									
HCM 2010 LOS			A									

Lane Group	WBL	WBR	NBL	NBR	SBL	SBR
Lane Configurations	↙	↗	↑	↖	↘	↑
Volume (vph)	147	77	825	89	21	999
Ideal Flow (vphpl)	1800	1800	1800	1800	1800	1800
Lane Width (ft)	12	14	12	14	12	12
Grade (%)	0%		1%			0%
Storage Length (ft)	0	200		150	150	
Storage Lanes	1	1		1	1	
Taper Length (ft)	75				75	
Lane Util. Factor	1.00	1.00	1.00	1.00	1.00	1.00
Frt		0.850		0.850		
Fit Protected	0.950				0.950	
Satd. Flow (prot)	1676	1600	1756	1592	1676	1765
Fit Permitted	0.950				0.268	
Satd. Flow (perm)	1676	1600	1756	1592	473	1765
Right Turn on Red		Yes		Yes		
Satd. Flow (RTOR)		80		91		
Link Speed (mph)	25		40			40
Link Distance (ft)	593		817			600
Travel Time (s)	16.2		13.9			10.2
Peak Hour Factor	0.96	0.96	0.96	0.96	0.96	0.96
Adj. Flow (vph)	153	80	859	93	22	1041
Shared Lane Traffic (%)						
Lane Group Flow (vph)	153	80	859	93	22	1041
Number of Detectors	1	1	1	1	1	1
Detector Template	Left	Right	Thru	Right	Left	Thru
Leading Detector (ft)	35	35	5	5	35	5
Trailing Detector (ft)	-5	-5	0	0	-5	0
Detector 1 Position(ft)	-5	-5	0	0	-5	0
Detector 1 Size(ft)	40	40	5	5	40	5
Detector 1 Type	CI+Ex	CI+Ex	CI+Ex	CI+Ex	CI+Ex	CI+Ex
Detector 1 Channel						
Detector 1 Extend (s)	0.0	0.0	0.0	0.0	0.0	0.0
Detector 1 Queue (s)	0.0	0.0	0.0	0.0	0.0	0.0
Detector 1 Delay (s)	0.0	0.0	0.0	0.0	0.0	0.0
Turn Type	Prot	Perm	NA	Perm	Perm	NA
Protected Phases	8		2			6
Permitted Phases		8		2	6	
Detector Phase	8	8	2	2	6	6
Switch Phase						
Minimum Initial (s)	15.0	15.0	20.0	20.0	20.0	20.0
Minimum Split (s)	21.0	21.0	26.0	26.0	26.0	26.0
Total Split (s)	25.0	25.0	95.0	95.0	95.0	95.0
Total Split (%)	20.8%	20.8%	79.2%	79.2%	79.2%	79.2%
Maximum Green (s)	19.0	19.0	89.0	89.0	89.0	89.0
Yellow Time (s)	4.0	4.0	4.0	4.0	4.0	4.0
All-Red Time (s)	2.0	2.0	2.0	2.0	2.0	2.0
Lost Time Adjust (s)	-1.0	-1.0	-1.0	-1.0	-1.0	-1.0
Total Lost Time (s)	5.0	5.0	5.0	5.0	5.0	5.0
Lead/Lag						

BT Dreshertown, LP
 5: Dreshertown Road & Dryden Road

2023 With PM Peak (Residential and Office)



Lane Group	WBL	WBR	NBT	NBR	SBL	SBR
Lead-Lag Optimize?						
Vehicle Extension (s)	3.0	3.0	3.0	3.0	3.0	3.0
Recall Mode	None	None	C-Max	C-Max	C-Max	C-Max

Intersection Summary

Area Type: Other
 Cycle Length: 120
 Actuated Cycle Length: 120
 Offset: 60 (50%), Referenced to phase 2:NBT and 6:SBR, Start of 1st Green
 Natural Cycle: 75
 Control Type: Actuated-Coordinated

Splits and Phases: 5: Dreshertown Road & Dryden Road

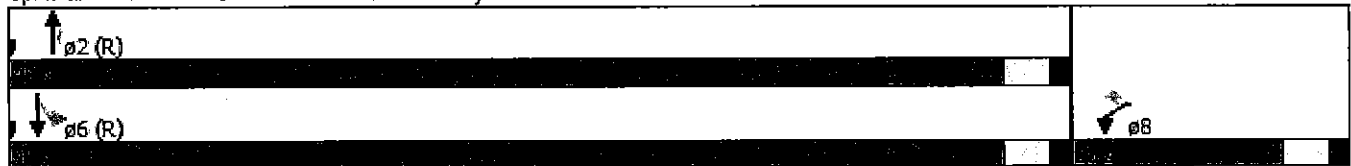

	↙	↖	↑	↗	↘	↓		
Movement	WBL	WBR	NBL	NBR	SBL	SBT		
Lane Configurations	↙	↖	↑	↗	↘	↓		
Volume (veh/h)	147	77	825	89	21	999		
Number	3	18	2	12	1	6		
Initial Q (Qb), veh	0	0	0	0	0	0		
Ped-Bike Adj(A_pbT)	1.00	1.00		1.00	1.00			
Parking Bus, Adj	1.00	1.00	1.00	1.00	1.00	1.00		
Adj Sat Flow, veh/h/ln	1765	1835	1756	1826	1765	1765		
Adj Flow Rate, veh/h	153	80	859	93	22	1041		
Adj No. of Lanes	1	1	1	1	1	1		
Peak Hour Factor	0.96	0.96	0.96	0.96	0.96	0.96		
Percent Heavy Veh, %	2	2	2	2	2	2		
Cap, veh/h	224	208	1376	1216	398	1382		
Arrive On Green	0.13	0.13	0.78	0.78	0.78	0.78		
Sat Flow, veh/h	1681	1560	1756	1552	587	1765		
Grp Volume(v), veh/h	153	80	859	93	22	1041		
Grp Sat Flow(s), veh/h/ln	1681	1560	1756	1552	587	1765		
Q Serve(g_s), s	10.4	5.6	24.9	1.7	2.0	37.4		
Cycle Q Clear(g_c), s	10.4	5.6	24.9	1.7	26.9	37.4		
Prop In Lane	1.00	1.00		1.00	1.00			
Lane Grp Cap(c), veh/h	224	208	1376	1216	398	1382		
V/C Ratio(X)	0.68	0.38	0.62	0.08	0.06	0.75		
Avail Cap(c_a), veh/h	280	260	1376	1216	398	1382		
HCM Platoon Ratio	1.00	1.00	1.00	1.00	1.00	1.00		
Upstream Filter(I)	1.00	1.00	1.00	1.00	0.52	0.52		
Uniform Delay (d), s/veh	49.6	47.5	5.5	3.0	11.2	6.9		
Incr Delay (d2), s/veh	4.8	1.2	2.1	0.1	0.1	2.0		
Initial Q Delay(d3),s/veh	0.0	0.0	0.0	0.0	0.0	0.0		
%ile BackOfQ(95%),veh/ln	8.9	4.5	18.3	1.3	0.6	23.5		
LnGrp Delay(d),s/veh	54.4	48.7	7.7	3.1	11.3	8.9		
LnGrp LOS	D	D	A	A	B	A		
Approach Vol, veh/h	233		952			1063		
Approach Delay, s/veh	52.4		7.2			9.0		
Approach LOS	D		A			A		
Phase	1	2	3	4	5	6	7	8
Assigned Phs		2				6		8
Phs Duration (G+Y+Rc), s		99.0				99.0		21.0
Change Period (Y+Rc), s		6.0				6.0		6.0
Max Green Setting (Gmax), s		89.0				89.0		19.0
Max Q Clear Time (g_c+I1), s		27.4				39.9		12.9
Green Ext Time (p_c), s		8.7				8.6		0.4
Intersection Summary								
HCM 2010 Ctrl Delay			12.7					
HCM 2010 LOS			B					

1: Jarrettown Road/Village Road & Welsh Road



Lane Group	EBI	EBT	EBR	WBL	WBT	WBR	NBL	NBT	NBR	SBL	SBT	SBR
Lane Configurations	↖	↕		↖	↕			↖	↕		↕	
Volume (vph)	11	636	20	143	593	8	7	2	195	13	2	7
Ideal Flow (vphpl)	1800	1800	1800	1800	1800	1800	1800	1800	1800	1800	1800	1800
Lane Width (ft)	12	12	12	11	14	14	12	12	14	15	15	15
Grade (%)		-6%			1%			-1%			1%	
Storage Length (ft)	150		0	100		0	0		175	0		0
Storage Lanes	1		0	1		0	0		1	0		0
Taper Length (ft)	75			75			75			75		
Lane Util. Factor	1.00	0.95	0.95	1.00	1.00	1.00	1.00	1.00	1.00	1.00	1.00	1.00
Frnt		0.995			0.998				0.850		0.955	
Fit Protected	0.950			0.950				0.962			0.972	
Satd. Flow (prot)	1761	3445	0	1612	1907	0	0	1740	1640	0	1829	0
Fit Permitted	0.414			0.339				0.857			0.815	
Satd. Flow (perm)	768	3445	0	575	1907	0	0	1550	1640	0	1533	0
Right Turn on Red			Yes			Yes			Yes			Yes
Satd. Flow (RTOR)		5			2				214		8	
Link Speed (mph)		45			45			35			35	
Link Distance (ft)		1263			605			421			431	
Travel Time (s)		19.1			9.2			8.2			8.4	
Peak Hour Factor	0.91	0.91	0.91	0.91	0.91	0.91	0.91	0.91	0.91	0.91	0.91	0.91
Heavy Vehicles (%)	0%	1%	25%	2%	0%	0%	0%	0%	0%	0%	0%	0%
Adj. Flow (vph)	12	699	22	157	652	9	8	2	214	14	2	8
Shared Lane Traffic (%)												
Lane Group Flow (vph)	12	721	0	157	661	0	0	10	214	0	24	0
Number of Detectors	1	2		1	2		1	1	1	1	1	
Detector Template	Left			Left			Left	Thru	Right	Left	Thru	
Leading Detector (ft)	5	330		35	330		20	35	35	20	35	
Trailing Detector (ft)	0	0		-5	0		0	-5	-5	0	-5	
Detector 1 Position(ft)	0	0		-5	0		0	-5	-5	0	-5	
Detector 1 Size(ft)	5	6		40	6		20	40	40	20	40	
Detector 1 Type	CI+Ex	CI+Ex		CI+Ex	CI+Ex		CI+Ex	CI+Ex	CI+Ex	CI+Ex	CI+Ex	
Detector 1 Channel												
Detector 1 Extend (s)	0.0	0.0		0.0	0.0		0.0	0.0	0.0	0.0	0.0	
Detector 1 Queue (s)	0.0	0.0		0.0	0.0		0.0	0.0	0.0	0.0	0.0	
Detector 1 Delay (s)	0.0	0.0		0.0	0.0		0.0	0.0	0.0	0.0	0.0	
Detector 2 Position(ft)		324			324							
Detector 2 Size(ft)		6			6							
Detector 2 Type		CI+Ex			CI+Ex							
Detector 2 Channel												
Detector 2 Extend (s)		0.0			0.0							
Turn Type	Perm	NA		pm+pt	NA		Perm	NA	pm+ov	Perm	NA	
Protected Phases		2		1	6			8	1		4	
Permitted Phases	2			6			8		8	4		
Detector Phase	2	2		1	6		8	8	1	4	4	
Switch Phase												
Minimum Initial (s)	15.0	15.0		3.0	15.0		7.0	7.0	3.0	7.0	7.0	
Minimum Split (s)	22.0	22.0		10.0	22.0		13.0	13.0	10.0	13.0	13.0	
Total Split (s)	63.0	63.0		19.0	82.0		18.0	18.0	19.0	18.0	18.0	
Total Split (%)	63.0%	63.0%		19.0%	82.0%		18.0%	18.0%	19.0%	18.0%	18.0%	

1: Jarretstown Road/Village Road & Welsh Road



Lane Group	EBL	EBT	EBR	WBL	WBT	WBR	NBL	NBT	NBR	SBL	SBT	SBR
Maximum Green (s)	56.0	56.0		12.0	75.0		12.0	12.0	12.0	12.0	12.0	12.0
Yellow Time (s)	5.0	5.0		5.0	5.0		4.0	4.0	5.0	4.0	4.0	4.0
All-Red Time (s)	2.0	2.0		2.0	2.0		2.0	2.0	2.0	2.0	2.0	2.0
Lost Time Adjust (s)	-1.0	-1.0		-1.0	-1.0			-1.0	-1.0			-1.0
Total Lost Time (s)	6.0	6.0		6.0	6.0			5.0	6.0			5.0
Lead/Lag	Lag	Lag		Lead					Lead			
Lead-Lag Optimize?												
Vehicle Extension (s)	3.0	3.0		3.0	3.0		3.0	3.0	3.0	3.0	3.0	3.0
Recall Mode	C-Max	C-Max		None	C-Max		None	None	None	None	None	None

Intersection Summary

Area Type: Other
 Cycle Length: 100
 Actuated Cycle Length: 100
 Offset: 26 (26%), Referenced to phase 2:EBTL and 6:WBTL, Start of 1st Green
 Natural Cycle: 45
 Control Type: Actuated-Coordinated

Splits and Phases: 1: Jarretstown Road/Village Road & Welsh Road

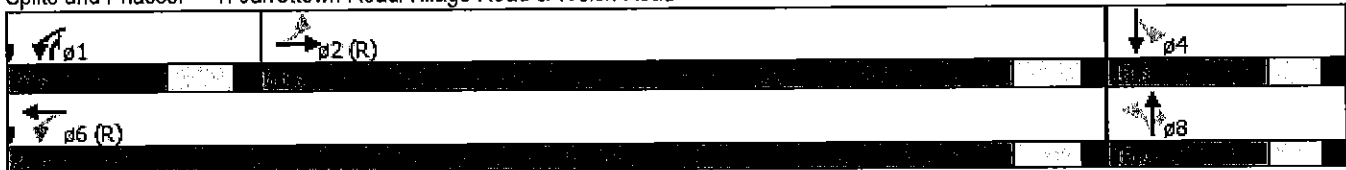

1: Jarretstown Road/Village Road & Welsh Road

Movement	EBL	EBI	FBR	WBL	WBT	WBR	NBL	NET	NBR	SBL	SBT	SBR
Lane Configurations	↖	↕		↖	↗			↕	↗		↕	
Volume (veh/h)	11	636	20	143	593	8	7	2	195	13	2	7
Number	5	2	12	1	6	16	3	8	18	7	4	14
Initial Q (Qb), veh	0	0	0	0	0	0	0	0	0	0	0	0
Ped-Bike Adj(A_pbT)	1.00		1.00	1.00		1.00	1.00		1.00	1.00		1.00
Parking Bus, Adj	1.00	1.00	1.00	1.00	1.00	1.00	1.00	1.00	1.00	1.00	1.00	1.00
Adj Sat Flow, veh/h/ln	1854	1822	1854	1756	1863	1863	1809	1809	1881	1863	1863	1863
Adj Flow Rate, veh/h	12	699	21	157	652	9	8	2	116	14	2	3
Adj No. of Lanes	1	2	0	1	1	0	0	1	1	0	1	0
Peak Hour Factor	0.91	0.91	0.91	0.91	0.91	0.91	0.91	0.91	0.91	0.91	0.91	0.91
Percent Heavy Veh, %	0	1	1	2	0	0	0	0	0	0	0	0
Cap, veh/h	613	2293	69	599	1448	20	179	39	259	159	26	23
Arrive On Green	0.67	0.67	0.66	0.06	0.79	0.78	0.09	0.10	0.10	0.09	0.10	0.09
Sat Flow, veh/h	810	3432	103	1672	1833	25	1146	387	1599	960	258	228
Grp Volume(v), veh/h	12	352	368	157	0	661	10	0	116	19	0	0
Grp Sat Flow(s), veh/h/ln	810	1731	1804	1672	0	1858	1533	0	1599	1447	0	0
Q Serve(g_s), s	0.5	8.5	8.5	2.5	0.0	11.6	0.0	0.0	6.6	0.3	0.0	0.0
Cycle Q Clear(g_c), s	0.5	8.5	8.5	2.5	0.0	11.6	0.5	0.0	6.6	1.0	0.0	0.0
Prop In Lane	1.00		0.06	1.00		0.01	0.80		1.00	0.74		0.16
Lane Grp Cap(c), veh/h	613	1156	1205	599	0	1468	203	0	259	193	0	0
V/C Ratio(X)	0.02	0.30	0.30	0.26	0.00	0.45	0.05	0.00	0.45	0.10	0.00	0.00
Avail Cap(c_a), veh/h	613	1156	1205	713	0	1468	248	0	307	235	0	0
HCM Platoon Ratio	1.00	1.00	1.00	1.00	1.00	1.00	1.00	1.00	1.00	1.00	1.00	1.00
Upstream Filter(I)	1.00	1.00	1.00	1.00	0.00	1.00	1.00	0.00	1.00	1.00	0.00	0.00
Uniform Delay (d), s/veh	5.6	6.9	6.9	4.1	0.0	3.4	41.1	0.0	37.9	41.3	0.0	0.0
Incr Delay (d2), s/veh	0.1	0.7	0.7	0.2	0.0	1.0	0.1	0.0	1.2	0.2	0.0	0.0
Initial Q Delay(d3),s/veh	0.0	0.0	0.0	0.0	0.0	0.0	0.0	0.0	0.0	0.0	0.0	0.0
%ile BackOfQ(95%),veh/ln	0.2	7.6	7.9	2.1	0.0	10.4	0.5	0.0	5.4	0.9	0.0	0.0
LnGrp Delay(d),s/veh	5.7	7.6	7.6	4.3	0.0	4.4	41.2	0.0	39.1	41.6	0.0	0.0
LnGrp LOS	A	A	A	A		A	D		D	D		
Approach Vol, veh/h		732			818			126				19
Approach Delay, s/veh		7.6			4.4			39.2				41.6
Approach LOS		A			A			D				D
Parameter	1	2	3	4	5	6	7	8				
Assigned Phs	1	2		4		6		8				
Phs Duration (G+Y+Rc), s	12.2	72.8		15.0		85.0		15.0				
Change Period (Y+Rc), s	7.0	7.0		6.0		7.0		6.0				
Max Green Setting (Gmax), s	12.0	56.0		12.0		75.0		12.0				
Max Q Clear Time (g_c+I1), s	5.0	11.0		3.0		13.6		9.1				
Green Ext Time (p_c), s	0.2	32.6		0.3		40.5		0.1				
Intersection Summary												
HCM 2010 Ctrl Delay			8.8									
HCM 2010 LOS			A									

BT Dreshertown, LP
2: Welsh Road & Dresher Road

2023 With SAT Peak (Residential and Office)

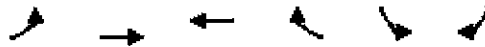

Lane Group	FBL	EBT	WBT	WBR	SBL	SBR
Lane Configurations	↖	↕	↕	↗	↖	↗
Volume (vph)	154	722	635	406	370	148
Ideal Flow (vphpl)	1800	1800	1800	1800	1800	1800
Lane Width (ft)	10	11	11	11	12	13
Grade (%)		-1%	1%		1%	
Storage Length (ft)	225			210	0	415
Storage Lanes	1			1	2	1
Taper Length (ft)	75				75	
Lane Util. Factor	1.00	0.95	0.95	1.00	0.97	1.00
Frt				0.850		0.850
Flt Protected	0.950				0.950	
Satd. Flow (prot)	1573	3290	3257	1472	3301	1542
Flt Permitted	0.316				0.950	
Satd. Flow (perm)	523	3290	3257	1472	3301	1542
Right Turn on Red				Yes		Yes
Satd. Flow (RTOR)				437		114
Link Speed (mph)		45	45		35	
Link Distance (ft)		475	550		970	
Travel Time (s)		7.2	8.3		18.9	
Peak Hour Factor	0.93	0.93	0.93	0.93	0.93	0.93
Heavy Vehicles (%)	2%	1%	1%	0%	0%	2%
Adj. Flow (vph)	166	776	683	437	398	159
Shared Lane Traffic (%)						
Lane Group Flow (vph)	166	776	683	437	398	159
Number of Detectors	1	1	1	1	1	1
Detector Template						
Leading Detector (ft)	35	5	5	5	35	35
Trailing Detector (ft)	-5	0	0	0	-5	-5
Detector 1 Position(ft)	-5	0	0	0	-5	-5
Detector 1 Size(ft)	40	5	5	5	40	40
Detector 1 Type	Cl+Ex	Cl+Ex	Cl+Ex	Cl+Ex	Cl+Ex	Cl+Ex
Detector 1 Channel						
Detector 1 Extend (s)	0.0	0.0	0.0	0.0	0.0	0.0
Detector 1 Queue (s)	0.0	0.0	0.0	0.0	0.0	0.0
Detector 1 Delay (s)	0.0	0.0	0.0	0.0	0.0	0.0
Turn Type	pm+pt	NA	NA	pm+ov	Prot	pm+ov
Protected Phases	5	2	6	4	4	5
Permitted Phases	2			6		4
Detector Phase	5	2	6	4	4	5
Switch Phase						
Minimum Initial (s)	3.0	20.0	20.0	7.0	7.0	3.0
Minimum Split (s)	9.0	26.0	26.0	14.0	14.0	9.0
Total Split (s)	23.0	68.0	45.0	32.0	32.0	23.0
Total Split (%)	23.0%	68.0%	45.0%	32.0%	32.0%	23.0%
Maximum Green (s)	17.0	62.0	39.0	25.0	25.0	17.0
Yellow Time (s)	4.0	4.0	4.0	4.0	4.0	4.0
All-Red Time (s)	2.0	2.0	2.0	3.0	3.0	2.0
Lost Time Adjust (s)	-1.0	-1.0	-1.0	-1.0	-1.0	-1.0
Total Lost Time (s)	5.0	5.0	5.0	6.0	6.0	5.0

BT Dreshertown, LP
2: Welsh Road & Dresher Road

2023 With SAT Peak (Residential and Office)

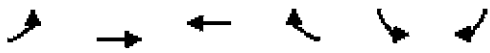

Lane Group	FBL	EBT	WBT	WBR	SBL	SBR
Lead/Lag	Lead		Lag		Lead	
Lead-Lag Optimize?						
Vehicle Extension (s)	3.0	3.0	3.0	3.0	3.0	3.0
Recall Mode	None	C-Max	C-Max	None	None	None
Act Effct Green (s)	69.5	69.5	54.0	78.6	19.5	36.0
Actuated g/C Ratio	0.70	0.70	0.54	0.79	0.20	0.36
v/c Ratio	0.35	0.34	0.39	0.35	0.62	0.25
Control Delay	7.6	5.4	14.7	2.5	40.6	7.4
Queue Delay	0.0	0.0	0.0	0.0	0.0	0.0
Total Delay	7.6	5.4	14.7	2.5	40.6	7.4
LOS	A	A	B	A	D	A
Approach Delay		5.8	9.9		31.1	
Approach LOS		A	A		C	
Queue Length 50th (ft)	24	60	137	42	121	19
Queue Length 95th (ft)	49	95	170	72	157	53
Internal Link Dist (ft)		395	470		890	
Turn Bay Length (ft)	225			210		415
Base Capacity (vph)	552	2285	1760	1317	858	735
Starvation Cap Reductn	0	0	0	0	0	0
Spillback Cap Reductn	0	0	0	0	0	0
Storage Cap Reductn	0	0	0	0	0	0
Reduced v/c Ratio	0.30	0.34	0.39	0.33	0.46	0.22

Intersection Summary

Area Type: Other
 Cycle Length: 100
 Actuated Cycle Length: 100
 Offset: 38 (38%), Referenced to phase 2:EBTL and 6:WBT, Start of 1st Green
 Natural Cycle: 50
 Control Type: Actuated-Coordinated
 Maximum v/c Ratio: 0.62
 Intersection Signal Delay: 13.0
 Intersection Capacity Utilization 52.0%
 Analysis Period (min) 15
 Intersection LOS: B
 ICU Level of Service A

Splits and Phases: 2: Welsh Road & Dresher Road

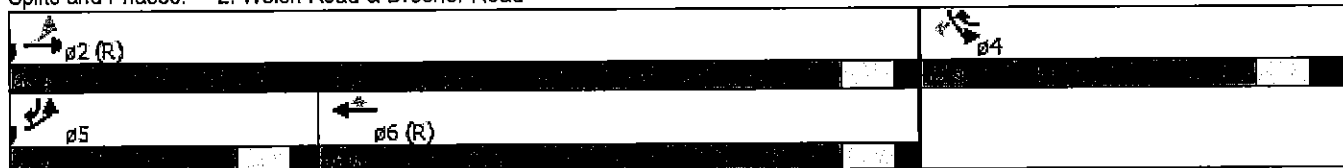

BT Dreshertown, LP
3: Dreshertown Road & Welsh Road

2023 With SAT Peak (Residential and Office)



Lane Group	EBT	EBR	WBI	WBT	NBL	NBR
Lane Configurations	↑↑	↑	↑	↑↑	↑↑	↑
Volume (vph)	899	193	223	852	190	264
Ideal Flow (vphpl)	1800	1800	1800	1800	1800	1800
Lane Width (ft)	11	15	10	12	12	15
Grade (%)	-2%			1%	1%	
Storage Length (ft)		150	175		0	350
Storage Lanes		1	1		2	2
Taper Length (ft)			75		75	
Lane Util. Factor	0.95	1.00	1.00	0.95	0.97	1.00
Frt		0.850				0.850
Fit Protected			0.950		0.950	
Satd. Flow (prot)	3339	1683	1588	3403	3301	1675
Fit Permitted			0.215		0.950	
Satd. Flow (perm)	3339	1683	359	3403	3301	1675
Right Turn on Red		Yes				Yes
Satd. Flow (RTOR)		194				66
Link Speed (mph)	45			45	40	
Link Distance (ft)	550			1040	600	
Travel Time (s)	8.3			15.8	10.2	
Peak Hour Factor	0.91	0.91	0.91	0.91	0.91	0.91
Heavy Vehicles (%)	0%	1%	0%	0%	0%	0%
Adj. Flow (vph)	988	212	245	936	209	290
Shared Lane Traffic (%)						
Lane Group Flow (vph)	988	212	245	936	209	290
Number of Detectors	1	1	1	1	1	1
Detector Template						
Leading Detector (ft)	5	5	35	5	35	35
Trailing Detector (ft)	0	0	-5	0	-5	-5
Detector 1 Position(ft)	0	0	-5	0	-5	-5
Detector 1 Size(ft)	5	5	40	5	40	40
Detector 1 Type	CI+Ex	CI+Ex	CI+Ex	CI+Ex	CI+Ex	CI+Ex
Detector 1 Channel						
Detector 1 Extend (s)	0.0	0.0	0.0	0.0	0.0	0.0
Detector 1 Queue (s)	0.0	0.0	0.0	0.0	0.0	0.0
Detector 1 Delay (s)	0.0	0.0	0.0	0.0	0.0	0.0
Turn Type	NA	Perm	pm+pt	NA	Prot	pm+ov
Protected Phases	2		1	6	8	1
Permitted Phases		2	6			8
Detector Phase	2	2	1	6	8	1
Switch Phase						
Minimum Initial (s)	20.0	20.0	3.0	20.0	7.0	3.0
Minimum Split (s)	27.0	27.0	10.0	27.0	14.0	10.0
Total Split (s)	53.0	53.0	29.0	82.0	18.0	29.0
Total Split (%)	53.0%	53.0%	29.0%	82.0%	18.0%	29.0%
Maximum Green (s)	46.0	46.0	22.0	75.0	11.0	22.0
Yellow Time (s)	5.0	5.0	5.0	5.0	4.0	5.0
All-Red Time (s)	2.0	2.0	2.0	2.0	3.0	2.0
Lost Time Adjust (s)	-1.0	-1.0	-1.0	-1.0	-1.0	-1.0
Total Lost Time (s)	6.0	6.0	6.0	6.0	6.0	6.0

BT Dreshertown, LP
 3: Dreshertown Road & Welsh Road

2023 With SAT Peak (Residential and Office)



Lane Group	EBT	EBR	WBL	WBT	NBL	NBR
Lead/Lag	Lag	Lag	Lead			Lead
Lead-Lag Optimize?						
Vehicle Extension (s)	3.0	3.0	3.0	3.0	3.0	3.0
Recall Mode	C-Max	C-Max	None	C-Max	None	None

Intersection Summary

Area Type: Other
 Cycle Length: 100
 Actuated Cycle Length: 100
 Offset: 28 (28%), Referenced to phase 2:EBT and 6:WBTL, Start of 1st Green
 Natural Cycle: 60
 Control Type: Actuated-Coordinated

Splits and Phases: 3: Dreshertown Road & Welsh Road



	→	↘	↙	←	↖	↗		
Movement	EBF	EBR	WBI	WBT	NBL	NBR		
Lane Configurations	↑↑	↑	↓	↑↑	↓↓	↑		
Volume (veh/h)	899	193	223	852	190	264		
Number	2	12	1	6	3	18		
Initial Q (Qb), veh	0	0	0	0	0	0		
Ped-Bike Adj(A_pbT)		1.00	1.00		1.00	1.00		
Parking Bus, Adj	1.00	1.00	1.00	1.00	1.00	1.00		
Adj Sat Flow, veh/h/ln	1818	1872	1791	1791	1791	1863		
Adj Flow Rate, veh/h	988	212	245	936	209	204		
Adj No. of Lanes	2	1	1	2	2	1		
Peak Hour Factor	0.91	0.91	0.91	0.91	0.91	0.91		
Percent Heavy Veh, %	0	1	0	0	0	0		
Cap, veh/h	2103	969	514	2586	397	334		
Arrive On Green	1.00	1.00	0.18	1.00	0.12	0.12		
Sat Flow, veh/h	3545	1591	1706	3492	3309	1583		
Grp Volume(v), veh/h	988	212	245	936	209	204		
Grp Sat Flow(s),veh/h/ln	1727	1591	1706	1701	1655	1583		
Q Serve(g_s), s	0.0	0.0	5.0	0.0	5.9	11.7		
Cycle Q Clear(g_c), s	0.0	0.0	5.0	0.0	5.9	11.7		
Prop in Lane		1.00	1.00		1.00	1.00		
Lane Grp Cap(c), veh/h	2103	969	514	2586	397	334		
V/C Ratio(X)	0.47	0.22	0.48	0.36	0.53	0.61		
Avail Cap(c_a), veh/h	2103	969	751	2586	397	334		
HCM Platoon Ratio	2.00	2.00	2.00	2.00	1.00	1.00		
Upstream Filter(I)	0.90	0.90	0.92	0.92	0.95	0.95		
Uniform Delay (d), s/veh	0.0	0.0	4.1	0.0	41.3	35.7		
Incr Delay (d2), s/veh	0.7	0.5	0.6	0.4	1.2	3.1		
Initial Q Delay(d3),s/veh	0.0	0.0	0.0	0.0	0.0	0.0		
%ile BackOfQ(95%),veh/ln	0.4	0.2	4.1	0.2	5.0	9.1		
LnGrp Delay(d),s/veh	0.7	0.5	4.7	0.4	42.6	38.8		
LnGrp LOS	A	A	A	A	D	D		
Approach Vol, veh/h	1200			1181	413			
Approach Delay, s/veh	0.6			1.3	40.7			
Approach LOS	A			A	D			
Time	1	2	3	4	5	6	7	8
Assigned Phs	1	2				6		8
Phs Duration (G+Y+Rc), s	15.1	66.9				82.0		18.0
Change Period (Y+Rc), s	7.0	7.0				7.0		7.0
Max Green Setting (Gmax), s	22.0	46.0				75.0		11.0
Max Q Clear Time (g_c+I1), s	7.5	2.5				2.5		14.2
Green Ext Time (p_c), s	0.6	8.8				8.9		0.0
Intersection Summary								
HCM 2010 Ctrl Delay			6.8					
HCM 2010 LOS			A					

4: Dryden Road & Welsh Road

Lane Group	EBL	EBH	EBR	WBL	WBT	WBR	NBL	NBT	NBR	SBL	SBT	SBR
Lane Configurations												
Volume (vph)	2	1083	21	65	1069	2	18	0	71	2	0	2
Ideal Flow (vphpl)	1800	1800	1800	1800	1800	1800	1800	1800	1800	1800	1800	1800
Lane Width (ft)	10	12	14	10	12	12	11	15	15	12	14	14
Grade (%)		-1%			-1%			-1%			0%	
Storage Length (ft)	150		225	175		0	110		0	150		0
Storage Lanes	1		1	1		0	1		0	1		0
Taper Length (ft)	75			75			75			75		
Lane Util. Factor	1.00	0.95	1.00	1.00	0.95	0.95	1.00	1.00	1.00	1.00	1.00	1.00
Fr't			0.850					0.850			0.850	
Flt Protected	0.950			0.950			0.950			0.950		
Satd. Flow (prot)	1604	3437	1640	1604	3437	0	1661	1691	0	1710	1632	0
Flt Permitted	0.225			0.222			0.757			0.706		
Satd. Flow (perm)	380	3437	1640	375	3437	0	1324	1691	0	1271	1632	0
Right Turn on Red			Yes			Yes			Yes			Yes
Satd. Flow (RTOR)			33		1			151			155	
Link Speed (mph)		45			45			25			25	
Link Distance (ft)		1040			1416			754			960	
Travel Time (s)		15.8			21.5			20.6			26.2	
Peak Hour Factor	0.90	0.90	0.90	0.90	0.90	0.90	0.90	0.90	0.90	0.90	0.90	0.90
Heavy Vehicles (%)	0%	0%	0%	0%	0%	0%	0%	0%	0%	0%	0%	0%
Adj. Flow (vph)	2	1203	23	72	1188	2	20	0	79	2	0	2
Shared Lane Traffic (%)												
Lane Group Flow (vph)	2	1203	23	72	1190	0	20	79	0	2	2	0
Number of Detectors	1	1	1	1	1		1	1		1	1	
Detector Template												
Leading Detector (ft)	5	5	5	5	5		35	35		35	35	
Trailing Detector (ft)	0	0	0	0	0		-5	-5		-5	-5	
Detector 1 Position(ft)	0	0	0	0	0		-5	-5		-5	-5	
Detector 1 Size(ft)	5	5	5	5	5		40	40		40	40	
Detector 1 Type	CI+Ex	CI+Ex	CI+Ex	CI+Ex	CI+Ex		CI+Ex	CI+Ex		CI+Ex	CI+Ex	
Detector 1 Channel												
Detector 1 Extend (s)	0.0	0.0	0.0	0.0	0.0		0.0	0.0		0.0	0.0	
Detector 1 Queue (s)	0.0	0.0	0.0	0.0	0.0		0.0	0.0		0.0	0.0	
Detector 1 Delay (s)	0.0	0.0	0.0	0.0	0.0		0.0	0.0		0.0	0.0	
Turn Type	Perm	NA	Perm	Perm	NA		Perm	NA		Perm	NA	
Protected Phases		2			6			8			4	
Permitted Phases	2		2	6			8			4		
Detector Phase	2	2	2	6	6		8	8		4	4	
Switch Phase												
Minimum Initial (s)	21.0	21.0	21.0	21.0	21.0		5.0	5.0		5.0	5.0	
Minimum Split (s)	27.0	27.0	27.0	27.0	27.0		11.0	11.0		11.0	11.0	
Total Split (s)	85.0	85.0	85.0	85.0	85.0		15.0	15.0		15.0	15.0	
Total Split (%)	85.0%	85.0%	85.0%	85.0%	85.0%		15.0%	15.0%		15.0%	15.0%	
Maximum Green (s)	79.0	79.0	79.0	79.0	79.0		9.0	9.0		9.0	9.0	
Yellow Time (s)	4.0	4.0	4.0	4.0	4.0		3.0	3.0		3.0	3.0	
All-Red Time (s)	2.0	2.0	2.0	2.0	2.0		3.0	3.0		3.0	3.0	
Lost Time Adjust (s)	-1.0	-1.0	-1.0	-1.0	-1.0		-1.0	-1.0		-1.0	-1.0	
Total Lost Time (s)	5.0	5.0	5.0	5.0	5.0		5.0	5.0		5.0	5.0	

BT Dreshertown, LP
 4: Dryden Road & Welsh Road

2023 With SAT Peak (Residential and Office)



Lane Group	EBL	EBT	EBR	WBL	WBT	WBR	NBL	NBT	NBR	SBL	SBT	SBR
Lead/Lag												
Lead-Lag Optimize?												
Vehicle Extension (s)	3.0	3.0	3.0	3.0	3.0		3.0	3.0		3.0	3.0	
Recall Mode	C-Max	C-Max	C-Max	C-Max	C-Max		None	None		None	None	

Intersection Summary

Area Type: Other
 Cycle Length: 100
 Actuated Cycle Length: 100
 Offset: 41 (41%), Referenced to phase 2:EBTL and 6:WBTL, Start of 1st Green
 Natural Cycle: 40
 Control Type: Actuated-Coordinated

Splits and Phases: 4: Dryden Road & Welsh Road

p2 (R)	p4
p6 (R)	p8



Movement	EBL	EBT	EBR	WBL	WBT	WBR	NBL	NET	NBR	SBL	SBT	SEB
Lane Configurations	↖	↗	↘	↙	↕	↖	↗	↘	↙	↕	↖	↗
Volume (veh/h)	2	1083	21	65	1069	2	18	0	71	2	0	2
Number	5	2	12	1	6	16	3	8	18	7	4	14
Initial Q (Qb), veh	0	0	0	0	0	0	0	0	0	0	0	0
Ped-Bike Adj(A_pbT)	1.00		1.00	1.00		1.00	1.00		1.00	1.00		1.00
Parking Bus, Adj	1.00	1.00	1.00	1.00	1.00	1.00	1.00	1.00	1.00	1.00	1.00	1.00
Adj Sat Flow, veh/h/ln	1809	1809	1881	1809	1809	1809	1809	1881	1881	1800	1872	1872
Adj Flow Rate, veh/h	2	1203	21	72	1188	2	20	0	79	2	0	2
Adj No. of Lanes	1	2	1	1	2	0	1	1	0	1	1	0
Peak Hour Factor	0.90	0.90	0.90	0.90	0.90	0.90	0.90	0.90	0.90	0.90	0.90	0.90
Percent Heavy Veh, %	0	0	0	0	0	0	0	0	0	0	0	0
Cap, veh/h	425	2832	1317	455	2900	5	182	0	122	116	0	121
Arrive On Green	1.00	1.00	1.00	0.82	0.82	0.81	0.08	0.00	0.07	0.08	0.00	0.07
Sat Flow, veh/h	480	3437	1599	465	3521	6	1445	0	1599	1341	0	1591
Grp Volume(v), veh/h	2	1203	21	72	580	610	20	0	79	2	0	2
Grp Sat Flow(s), veh/h/ln	480	1719	1599	465	1719	1808	1445	0	1599	1341	0	1591
Q Serve(g_s), s	0.0	0.0	0.0	3.2	9.0	9.0	1.3	0.0	4.8	0.1	0.0	0.1
Cycle Q Clear(g_c), s	9.0	0.0	0.0	3.2	9.0	9.0	1.3	0.0	4.8	4.5	0.0	0.1
Prop In Lane	1.00		1.00	1.00		0.00	1.00		1.00	1.00		1.00
Lane Grp Cap(c), veh/h	425	2832	1317	455	1416	1490	182	0	122	116	0	121
V/C Ratio(X)	0.00	0.42	0.02	0.16	0.41	0.41	0.11	0.00	0.65	0.02	0.00	0.02
Avail Cap(c_a), veh/h	425	2832	1317	455	1416	1490	216	0	160	148	0	159
HCM Platoon Ratio	2.00	2.00	2.00	1.00	1.00	1.00	1.00	1.00	1.00	1.00	1.00	1.00
Upstream Filter(I)	0.85	0.85	0.85	1.00	1.00	1.00	1.00	0.00	1.00	1.00	0.00	1.00
Uniform Delay (d), s/veh	0.5	0.0	0.0	1.8	2.3	2.3	43.3	0.0	45.4	46.8	0.0	43.2
Incr Delay (d2), s/veh	0.0	0.4	0.0	0.7	0.9	0.8	0.3	0.0	5.7	0.1	0.0	0.1
Initial Q Delay(d3),s/veh	0.0	0.0	0.0	0.0	0.0	0.0	0.0	0.0	0.0	0.0	0.0	0.0
%ile BackOfQ(95%),veh/ln	0.0	0.3	0.0	0.9	8.0	8.3	1.0	0.0	4.2	0.1	0.0	0.1
LnGrp Delay(d),s/veh	0.5	0.4	0.0	2.6	3.2	3.2	43.5	0.0	51.1	46.9	0.0	43.2
LnGrp LOS	A	A	A	A	A	A	D		D	D		D
Approach Vol, veh/h		1226			1262			99				4
Approach Delay, s/veh		0.4			3.2			49.6				45.1
Approach LOS		A			A			D				D

Timer	1	2	3	4	5	6	7	8
Assigned Phs		2		4		6		8
Phs Duration (G+Y+Rc), s		87.4		12.6		87.4		12.6
Change Period (Y+Rc), s		6.0		6.0		6.0		6.0
Max Green Setting (Gmax), s		79.0		9.0		79.0		9.0
Max Q Clear Time (g_c+I1), s		11.5		7.0		11.5		6.8
Green Ext Time (p_c), s		11.9		0.1		11.9		0.1

Interaction Summary	
HCM 2010 Ctrl Delay	3.7
HCM 2010 LOS	A

BT Dreshertown, LP
5: Dreshertown Road & Dryden Road

2023 With SAT Peak (Residential and Office)



Lane Group	WBL	WBR	INBT	INBR	SBL	SBR
Lane Configurations	↶	↷	↕	↷	↶	↕
Volume (vph)	52	13	441	63	14	402
Ideal Flow (vphpl)	1800	1800	1800	1800	1800	1800
Lane Width (ft)	12	14	12	14	12	12
Grade (%)	0%		1%			0%
Storage Length (ft)	0	200		150	150	
Storage Lanes	1	1		1	1	
Taper Length (ft)	75				75	
Lane Util. Factor	1.00	1.00	1.00	1.00	1.00	1.00
Frnt		0.850		0.850		
Flt Protected	0.950				0.950	
Satd. Flow (prot)	1710	1632	1791	1624	1710	1800
Flt Permitted	0.950				0.465	
Satd. Flow (perm)	1710	1632	1791	1624	837	1800
Right Turn on Red		Yes		Yes		
Satd. Flow (RTOR)		14		69		
Link Speed (mph)	25		40			40
Link Distance (ft)	593		817			600
Travel Time (s)	16.2		13.9			10.2
Peak Hour Factor	0.91	0.91	0.91	0.91	0.91	0.91
Heavy Vehicles (%)	0%	0%	0%	0%	0%	0%
Adj. Flow (vph)	57	14	485	69	15	442
Shared Lane Traffic (%)						
Lane Group Flow (vph)	57	14	485	69	15	442
Number of Detectors	1	1	1	1	1	1
Detector Template	Left	Right	Thru	Right	Left	Thru
Leading Detector (ft)	35	35	5	5	35	5
Trailing Detector (ft)	-5	-5	0	0	-5	0
Detector 1 Position(ft)	-5	-5	0	0	-5	0
Detector 1 Size(ft)	40	40	5	5	40	5
Detector 1 Type	CI+Ex	CI+Ex	CI+Ex	CI+Ex	CI+Ex	CI+Ex
Detector 1 Channel						
Detector 1 Extend (s)	0.0	0.0	0.0	0.0	0.0	0.0
Detector 1 Queue (s)	0.0	0.0	0.0	0.0	0.0	0.0
Detector 1 Delay (s)	0.0	0.0	0.0	0.0	0.0	0.0
Turn Type	Prot	Perm	NA	Perm	Perm	NA
Protected Phases	8		2			6
Permitted Phases		8		2	6	
Detector Phase	8	8	2	2	6	6
Switch Phase						
Minimum Initial (s)	15.0	15.0	20.0	20.0	20.0	20.0
Minimum Split (s)	21.0	21.0	26.0	26.0	26.0	26.0
Total Split (s)	34.0	34.0	66.0	66.0	66.0	66.0
Total Split (%)	34.0%	34.0%	66.0%	66.0%	66.0%	66.0%
Maximum Green (s)	28.0	28.0	60.0	60.0	60.0	60.0
Yellow Time (s)	4.0	4.0	4.0	4.0	4.0	4.0
All-Red Time (s)	2.0	2.0	2.0	2.0	2.0	2.0
Lost Time Adjust (s)	-1.0	-1.0	-1.0	-1.0	-1.0	-1.0
Total Lost Time (s)	5.0	5.0	5.0	5.0	5.0	5.0

BT Dreshertown, LP
 5: Dreshertown Road & Dryden Road

2023 With SAT Peak (Residential and Office)



Lane Group	WBL	WBP	NBT	NBR	SBL	SBT
Lead/Lag						
Lead-Lag Optimize?						
Vehicle Extension (s)	3.0	3.0	3.0	3.0	3.0	3.0
Recall Mode	None	None	C-Max	C-Max	C-Max	C-Max

Intersection Summary
 Area Type: Other
 Cycle Length: 100
 Actuated Cycle Length: 100
 Offset: 0 (0%), Referenced to phase 2:NBT and 6:SBTL, Start of 1st Green
 Natural Cycle: 50
 Control Type: Actuated-Coordinated

Splits and Phases: 5: Dreshertown Road & Dryden Road

<p>↑ 02 (R)</p>	
<p>↓ 06 (R)</p>	<p>→ 08</p>

BT Dreshertown, LP
5: Dreshertown Road & Dryden Road

2023 With SAT Peak (Residential and Office)



Movement	WBL	WBR	NBT	NBR	SBL	SBT
Lane Configurations	↙	↗	↑	↗	↙	↑
Volume (veh/h)	52	13	441	63	14	402
Number	3	18	2	12	1	6
Initial Q (Qb), veh	0	0	0	0	0	0
Ped-Bike Adj(A_pbT)	1.00	1.00		1.00	1.00	
Parking Bus, Adj	1.00	1.00	1.00	1.00	1.00	1.00
Adj Sat Flow, veh/h/ln	1800	1872	1791	1863	1800	1800
Adj Flow Rate, veh/h	57	14	485	69	15	442
Adj No. of Lanes	1	1	1	1	1	1
Peak Hour Factor	0.91	0.91	0.91	0.91	0.91	0.91
Percent Heavy Veh, %	0	0	0	0	0	0
Cap, veh/h	239	221	1363	1205	655	1370
Arrive On Green	0.14	0.14	0.76	0.76	0.76	0.76
Sat Flow, veh/h	1714	1591	1791	1583	868	1800
Grp Volume(v), veh/h	57	14	485	69	15	442
Grp Sat Flow(s),veh/h/ln	1714	1591	1791	1583	868	1800
Q Serve(g_s), s	3.0	0.8	8.9	1.1	0.6	7.8
Cycle Q Clear(g_c), s	3.0	0.8	8.9	1.1	9.5	7.8
Prop In Lane	1.00	1.00		1.00	1.00	
Lane Grp Cap(c), veh/h	239	221	1363	1205	655	1370
V/C Ratio(X)	0.24	0.06	0.36	0.06	0.02	0.32
Avail Cap(c_a), veh/h	497	461	1363	1205	655	1370
HCM Platoon Ratio	1.00	1.00	1.00	1.00	1.00	1.00
Upstream Filter(I)	1.00	1.00	1.00	1.00	0.92	0.92
Uniform Delay (d), s/veh	38.3	37.4	3.9	3.0	5.5	3.8
Incr Delay (d2), s/veh	0.5	0.1	0.7	0.1	0.1	0.6
Initial Q Delay(d3),s/veh	0.0	0.0	0.0	0.0	0.0	0.0
%ile BackOfQ(95%),veh/ln	2.6	0.6	8.1	0.9	0.3	7.2
LnGrp Delay(d),s/veh	38.8	37.5	4.6	3.1	5.5	4.4
LnGrp LOS	D	D	A	A	A	A
Approach Vol, veh/h	71		554			457
Approach Delay, s/veh	38.6		4.5			4.4
Approach LOS	D		A			A

Timer	1	2	3	4	5	6	7	8
Assigned Phs		2				6		8
Phs Duration (G+Y+Rc), s		81.1				81.1		18.9
Change Period (Y+Rc), s		6.0				6.0		6.0
Max Green Setting (Gmax), s		60.0				60.0		28.0
Max Q Clear Time (g_c+I1), s		11.4				12.0		5.5
Green Ext Time (p_c), s		2.7				2.7		0.2

Intersection Summary	
HCM 2010 Ctrl Delay	6.7
HCM 2010 LOS	A